



Product Catalogue 2020

Manufacturing Medical Furniture & Equipment Since 1953



Welcome

Supplying Medical Furniture & Equipment Since 1953

With over 65 years of experience, Bristol Maid is a leading manufacturer and supplier of medical furniture & equipment. From design and manufacture to supply and installation, Bristol Maid has a reputation for providing high product quality, excellent customer service and value for money. We take pride in working in close partnership with our customers to deliver effective solutions based on innovative design and technology that will meet the demands of today while anticipating the solutions for tomorrow.

Our highly-trained staff are experienced in every aspect of customer support from simple product selection to bespoke technical solutions, from on-site audits to complex project management arrangements, according to our customers' needs.

Bristol Maid's commitment to quality is based on years of experience working with healthcare professionals in an exacting and regulated environment, and is supported by an ISO 9001:2015 quality management system that is registered with a UKAS accredited certification body.

If you require further assistance, please do not hesitate to contact our Customer Service team who are here to help; or alternatively can arrange for your Regional Sales Representative to visit and help find a solution that best suits your requirements.



Why Choose Bristol Maid?



Family business

Hospital Metalcraft Ltd is a family company. We own our factory, production lines and delivery lorries. We continually invest into our staff and the development of new product ranges.



Healthcare focused

With an extensive portfolio that covers almost every discipline, we have solutions to cater for the demands of the healthcare environment.



The best quality

With over 65 years' experience, we are focussed on the design and manufacture of high quality products which will create value for our customers. With a worldwide customer base, the Bristol Maid brand is recognised by many thousands of satisfied customers.



Manufactured in the UK

Hospital Metalcraft is proud to be a British manufacturing success story. Strict quality criteria are applied to both the Bristol Maid product range designed and produced within our own manufacturing facility and complementary equipment from carefully selected partners.



Delivered using our own lorries

Wherever possible we use our own fleet of lorries to ensure that your equipment arrives safe and secure.



Approved supplier

We are an accredited NHS & public sector accredited supplier. This allows you to buy with confidence knowing your requirements for compliant and competitive tendering has already been met.



Support you can rely on

Our external sales representative, sales support engineers and our Internal Customer Service Team are here to help you at every stage, from advice with product selection, managing the delivery of your order through to full service and repair support.



+44 (0)1258 484455



sales@bristolmaid.com



www.bristolmaid.com



Monday to Friday - 8:30am - 5:00pm



Blandford Heights, Blandford Forum
Dorset, DT11 7TG, UK

How To Order

Custom Design & Manufacture

Whether it is a trolley that is slightly lower, a work surface that is slightly larger, a cabinet that must fit into a specific space or a unique colour scheme on a bedside cabinet, we recognise that we may not always be able to provide a product that meets your specific requirements.

If you require a unique product, please contact us so we can work together to develop a solution that will exactly match your needs. Our design capability allows us to provide everything from minor product specification changes through to a full design & development service.

Tenders & Contracts

Through many years' experience we can support you with the facilitation and project management of tenders and contracts

- Site audits and equipment recommendations
- Scheduled deliveries
- Product placement
- Removal of packaging
- Installation
- Commissioning
- Training

NHS & Public Sector Accredited Supplier

Public sector organisations can take advantage of our nationally agreed discounts through the NHS Supply Chain and Shared Business Services. Buy with confidence knowing your requirement for compliant and competitive tendering has already been met.

NHS Supply Chain

Medical Furniture Equipment, Accessories,
Sackholders & Bins - Ref: 2019/S 137-337185
Ward & Residential Furniture - Ref: 2017/S 207-427709

Shared Business Services

Design, Furniture & Appliances - Ref: SBS/19/MA/TYX/9363/23

How To Order

How to Order

- Orders are required in writing, either by fax, email or post. Should you wish to order over the phone we would need to take full payment at the time of order by debit or credit card. Alternatively, we can send you a proforma invoice for payment (required to be paid in full prior to manufacture & delivery)
- Orders should be submitted as an 'official purchase order' on company headed paper with all information clearly displayed
- Your order should contain the following information...
 - Item No.
 - Description
 - Quantity
 - Delivery address
 - Invoice address
 - Full contact details, including name, email address, phone & fax numbers
- If applicable, please ensure our quotation reference is detailed on your order to ensure any agreed discounts are applied
- Item codes & descriptions in this catalogue supersede all previous editions
- A full price list can be requested from our website
- Payments can be made by cheque, bank transfer, credit or debit card (with the exception of American Express)
- If you are a new customer, the first three orders will be processed on a proforma basis, paid in full prior to manufacture & delivery, after which a credit account may be applied for
- For our terms and conditions refer to www.bristolmaid.com
- For further information and assistance, please contact our customer services team on +44 (0)1258 484455

Payment Options

BACS

- Payments to: HSBC Bank PLC
- Sort Code: 40-12-18
- Account Number: 11044052

Credit or Debit Card

- Major credit cards accepted



+44 (0)1258 484455 sales@bristolmaid.com www.bristolmaid.com

Monday to Friday - 8:30am - 5:00pm Blandford Heights, Blandford Forum Dorset, DT11 7TG, UK

+44 (0)1258 484455 sales@bristolmaid.com www.bristolmaid.com

Monday to Friday - 8:30am - 5:00pm Blandford Heights, Blandford Forum Dorset, DT11 7TG, UK

Bariatric Equipment

Folding Wheelchairs	8
Portering Chairs	9
Mobile Shower/Commode Chairs	11
Bariatric Shower Chairs	12
Shower/Commode Chairs	14
Chairs	15
Rollators & Training Suits	17

Bedside Cabinets & Overbed Tables

Polymer Bedside Cabinets	20
Bedside Cabinets	22
Bedside Cabinet Options	25
Bedside Cabinet/Wardrobe Combinations	26
Economy Overbed Table	30
Polymer Overbed & Overchair Tables	31
Laminate Overbed & Overchair Tables	32

Caretray Trolleys & Racks

Features	36
Disassembly & Cleaning	38
Stainless Steel, Low Level Trolleys	40
Stainless Steel, Standard Level Trolleys	42
Stainless Steel, High Level Trolleys	44
Stainless Steel, Mobile Racks	46
Stainless Steel, Static Racks	48
Mild Steel, Low Level Trolleys	50
Mild Steel, Standard Level Trolleys	52
Mild Steel, High Level Trolleys	54
Mild Steel, Mobile Racks	56
Mild Steel, Static Racks	58
Caretray Trolley Options	60

**Chart Trolleys, Workstations
Room Dividers & Screens**

Fixed Height Trolleys	72
Fixed Height Workstations	74
Variable Height Workstations	75
Chart Boards	76
Document Holders	77
Room Dividers	78
Curtain Screens	80
Solid Screens	81

Concealment Trolleys

Variable Height Trolleys	84
Fixed Height Trolleys	85
Body Trays & Covers	85

Cylinder Storage & Transportation

Cylinder Trolleys - F/G Size	88
Cylinder Trolleys - J Size	89
Bulk Transportation Trolleys	89
Cylinder Trolleys - E, CD/D, AF Size	90
Wall Brackets & Cylinder Holders	91

Dispensers, Holders & Racks

Apron Dispensers	94
Pocket Mask Holders	94
Glove Box Holders	95
Alcohol Gel Holders	96
Syringe Dispenser	96
Sharps Box Holder	97
Urine Bottle Holder	97
Catheter Bag Holders	97
Catheter Racks	98
Drainage Racks	99

Dressing / Instrument Trolleys

Removable Shelves, Stainless Steel	102
Removable Shelves, Mild Steel	103
Fixed Shelves, Sides Up	104
Fixed Shelves, Sides Down	105
Drawer Units	107
Options	108

Drug & Medicine Dispensing

Dispensing Trolleys	112
CLIQ® & RFID Solutions	115
Patient Administration Trolleys	116
Drawer Trolleys	118
Tray Trolleys	119
Blister Pack (MDS) Trolleys	120
Nomad® Cassette Trolleys	122
Biodose® & MultiMeds Trolleys	124
Medinox Trolleys	125
Laptop Holders	126
Security Clamp	128
Distribution Trolleys	129

Drug & Medicine Storage

Drug & Medicine Cabinets	132
Controlled Drug Cabinets	137
CLIQ™	140
Drug & Medicine Cupboards	142
Options	144
Patients / Residents Own Medication Cabinets	146
Tablet Counter & Storage Boxes	150
Pharmacy & Vaccine Refrigerators	151

**Examination / Treatment
Couches & Chairs**

Examination & Treatment Couches	154
Leg & Arm Rests	162
Couch Steps	163
Bariatric Examination & Treatment & Couches	164
Therapy Couches	170
Examination & Treatment Chairs	174
Bariatric Examination & Treatment Chairs	176
Phlebotomy Chairs	178
Options	181

General Purpose Trolleys

Stainless Steel Trolleys	186
Polymer Trolleys	188
Mild Steel Trolleys	189

HTM71 Storage Solutions

ScanCell® Carts	192
Distribution Trolleys	197
Open Transfer/Transport Trolleys	199
HTM71 Racking	200
Trays, Baskets, Dividers & Accessories	202

Infusion Stands & Accessories

Mobile Pump Stands	208
Mobile Infusion Stands	210
Clamping Infusion Stands	215
Wall Mounted Infusion Holders	215

Linen Trolleys & Bags

Soiled Linen Trolleys	218
Linen Trolleys	222
Hamper Trolleys	223
Soiled Linen Bags	223
Clean Linen Trolleys	224

Maternity Equipment

Variable Height Baby Cribs	230
Fixed Height Baby Cribs	232
Variable Height Baby Bath	233

Medical Records

Medical Records Trolleys	236
Medical Record Workstations	242
Laptop/Motion C5 Holders	244
Carefile Filing Pockets	246
CLIQ® & RFID Solutions	247
Medical Record Filing Trolleys	248
Medical Records Transfer Trolleys	249
Medical Records Cabinet	251

Phlebotomy

Caretray Trolley - Phlebotomy	254
Phlebotomy Chairs	256

Portering Chairs

Portering Chair - Rear Steer	262
Portering Chair - Front Steer	263
Portering Chair - Bariatric, Rear Steer	265
Options	266

Procedure Trolleys & Carts

Plaster Trolleys	270
Mobile Workstations	271
Procedure Carts	272

Resuscitation Trolleys & Carts

Resuscitation Trolleys	280
Caretray Trolley - Resuscitation	282
Resuscitation Carts - Polymer	284
Airways / Difficult Intubation Trolley	287

Sackholders & Waste Bins

Removable Body Bins	290
Free Standing Sackholders	295
Fixed Body Plastic Sackholders	296
Removable Body Plastic Sackholders	297

Seating Solutions

Office, Task & Operators Chairs	300
24 Hour Task & Operator Chairs	302
Bariatric Chairs	304
Saddle Stools	306
Low Back Patient Chairs	308
Medium & High Back Patient Armchairs	309
Reclining Armchairs	310
Bariatric Reclining Armchairs	320
Reclining Porters Armchairs	322
Rise & Recline Porters Armchairs	324
Seat, Back Cushion & Headrest Options	326
Overnight Chair	328
Soft Seating	330
Visitor & Waiting Room Seating	332
Waiting Room Seating	334
Tech Chairs & Stools	340
PU Tech Chairs & Stools	342
Static Safe Tech Chairs & Stools	344
Static Safe & Sterile Tech Chairs & Stools	346
Medical Grade Clean Room Tech Chairs	348

Sepsis Trolleys

Sepsis Trolleys	352
Options	353

Shelving & Racking Solutions

Polymer Racking - MetroMax I®	360
Polymer Racking - MetroMax Q®	362
Zinc Chrome Racking - Olympic®	364
High Density Storage - Top-Track®	366

Sterile Services Equipment

Preparation Tables - Variable Height	370
Preparation Tables - Fixed Height	371
Sterile Supplies Trolleys	372
Trolley Washer Compatible	374

Storage Cupboards, Cabinets & Lockers

Storage Cupboards	378
Storage Cabinets	380
First Aid & Clinical Reagent Cabinets	381
Key Cabinets	382
Storage / Personal Effects Lockers	384

Theatre Equipment

Bowl Stands	388
Bucket Stands	391
Instrument Trolleys	392
Mayo Tables & Operating Platforms	394
Suture Storage Trolleys	395
Sterile Container Storage	396

Workstations & Speciality Storage

Workstations	400
Storage Units	401
Catheter Storage Units	402

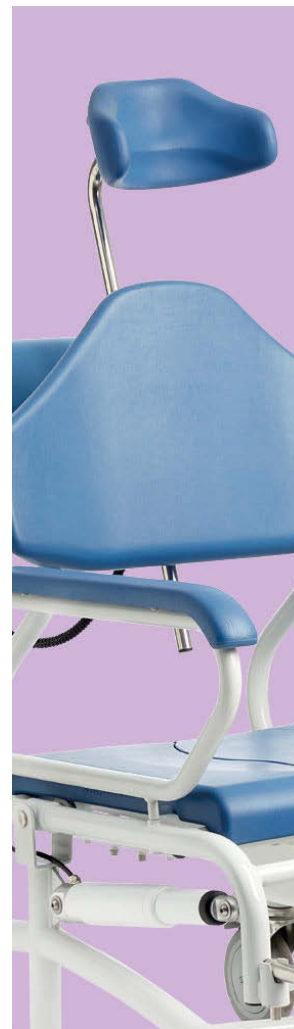

Bariatric Equipment

Folding Wheelchairs	8
Portering Chairs	9
Mobile Shower/Commode Chairs	11
Bariatric Shower Chairs	12
Shower/Commode Chairs	14
Chairs	15
Rollators & Training Suits	17



5X-0100-061-000/K



Disc-Brake Lever

Bariatric Folding Wheelchair - Minimaxx & Disc

Features

- Maximum capacity 325kg
- Powder coated chromium molybdenum steel frame
- Rigid folding mechanism
- Low seat height to assist access
- Viscoelastic foam cushion with two way stretch vapour permeable incontinence cover and non-slip base
- Padded push handles to assist the attendant/porter
- Puncture proof wheels & castors
- Parking brakes as standard/optional disc brake for improved control
- Side/width adjustable polyurethane moulded footrests, 100kg capacity

Dimensions (w x d x h)

- Seat Width - 610/710mm
- Seat Height - 430mm
- Seat Depth - 460mm
- Backrest Height - 510mm

Options

- 5X-0100-099-005 - Butterfly Armrests, Pair
- 5X-0100-099-006 - Angled Armrests, Pair
- 5X-0156-099-030 - Elevating Calf Support, Right Hand
- 5X-0156-099-031 - Elevating Calf Support, Left Hand
- 5X-0100-099-001 - Universal Table
- 5X-0100-099-020 - IV & O2 Holder, 100mm Dia

Spares

- 5X-0230-061-045 - Viscoelastic Cushion with Incontinence Cover, 610mm
- 5X-0230-071-045 - Viscoelastic Cushion with Incontinence Cover, 710mm

Item	Description	Overall Dimensions (w x d x h)	Weight
5X-0100-061-000/K	Minimaxx, 610mm	850 x 1100 x 990mm	27.0kg
5X-0100-071-000/K	Minimaxx, 710mm	950 x 1100 x 990mm	27.5kg
5X-0109-061-000/K	Minimaxx Disc, 610mm	850 x 1100 x 990mm	28.0kg
5X-0109-071-000/K	Minimaxx Disc, 710mm	950 x 1100 x 990mm	28.5kg



Universal Table

IV & O₂ Holder

Elevating Calf Support

Bariatric Folding Wheelchair - Minimaxx Push Motor

Features

- Maximum capacity 325kg
- Powder coated chromium molybdenum steel frame
- Rigid folding mechanism
- Low seat height to assist access
- Viscoelastic foam cushion with two way stretch vapour permeable incontinence cover and non-slip base
- Padded push handles to assist the attendant/porter
- Puncture proof wheels & castors
- Parking brakes as standard/optional disc brake for improved control
- Side/width adjustable polyurethane moulded footrests, 100kg capacity
- Push motor to assist the attendant/porter, reduces the risk of sore shoulders & stress on wrists
- Compatible on flat surfaces up to 5 degrees
- Operated using a control panel fitted to the handle, offering drive & reverse modes with speed control from 0.6-3.1mph
- One charge provides a range of 2.75miles
- Supplied with one removable battery and charger (battery has to be removed from the unit when charging)

Dimensions (w x d x h)

- Seat Width - 610/710mm
- Seat Height - 430mm
- Seat Depth - 460mm
- Backrest Height - 510mm

Options

- 5X-0100-099-005 - Butterfly Armrests, Pair
- 5X-0100-099-006 - Angled Armrests, Pair
- 5X-0156-099-030 - Elevating Calf Support, Right Hand
- 5X-0156-099-031 - Elevating Calf Support, Left Hand
- 5X-0100-099-001 - Universal Table
- 5X-0100-099-020 - IV & O2 Holder, 100mm Dia

Spares

- 5X-0230-061-045 - Viscoelastic Cushion with Incontinence Cover, 610mm
- 5X-0230-071-045 - Viscoelastic Cushion with Incontinence Cover, 710mm

Item	Description	Overall Dimensions (w x d x h)	Weight
5X-0110-061-000/K	Minimaxx, Push Motor, 610mm	850 x 1100 x 990mm	50.0kg
5X-0110-071-000/K	Minimaxx, Push Motor, 710mm	950 x 1100 x 990mm	50.5kg



5X-0110-061-000/K



Push Motor



Handle Mounted Control Panel



G/500/RS/VBB

Portering Chair - Bariatric, Rear Steer, Sliding Foot Rest

Features

- Maximum capacity 380kg
- Seamless & contoured upholstery using flame retardant vinyl
- Moulded drop down arm rests allows side access for patients and helpers
- Sliding rubber foot rest aids access as well as supporting feet during transit
- X-ray/notes pocket on rear of seat
- Two hooks for patients belongings
- Fittings to accept IV poles mounted to rear uprights
- Retractable diagonal seatbelt
- 200mm fixed wheels/200mm total stop braking castors (cushioned)
- We recommend that two members of staff are in attendance when used with a patient in excess of 190kg

Dimensions (w x d x h)

- Overall Dimensions - 930 x 1000 x 1090mm
- Seat Width 740mm
- Seat Height 530mm
- Seat Depth 670mm
- Backrest Height 480mm

Standard Colours

- Paint - Grey
- Upholstery - Bristol Blue

Options

- G/500/CYL - Cylinder Holder, CD/D
- G/CLS/500 - Calf/Leg Supports (pair)
- G/DP - Infusion Pole
- G/CARD/STATION - Head of Station
- G/CARD/LOCK - Card/Coin Lock, Factory Fitted
- 2LOKE011 - Release Card

Item	Description	Weight
G/500/RS/VBB	Rear Steer, Sliding Foot Rest, Bristol Blue	43.8kg

Alternative colours are available at extra cost. Change suffix 'VBB' on the product code with any of the following i.e. Rear Steer Portering Chairs - Bariatric, Sliding Foot Rest in Aqua Marine - G/500/RS/VAQ

Vinyl - Ambla New Richmond in Colour

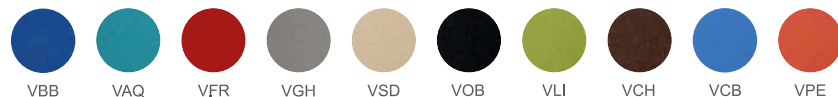

Bariatric Mobile Shower / Commode Chairs

Features

- Suitable for showering or toileting (supplied with a bucket & lid)
- Powder coated chromium molybdenum steel frame
- Available in two widths 610/710mm
- Rotating & removable straight or butterfly armrests to assist access
- Open back to allow easy sling access & assist positioning
- Polyurethane moulded seat & back
- Seat supplied with a removable lid
- Seat panel removable for cleaning
- Long open hole in seat (220mm at the widest point)
- Deep bucket with lid is removable from the front or back of the chair
- Side/width adjustable polyurethane moulded footrests, 100kg capacity
- 125mm swivel castors, 2 off braking
- Maximum capacity 325kg

Dimensions (w x d x h)

- Seat Width - 610/710mm
- Seat Height - 550mm
- Seat Depth - 560mm
- Backrest Height - 480mm

Standard Colours

- Paint - White
- Polyurethane - Blue

Options

- 5X-0150-999-022 - Seat Panel 610mm
- 5X-0150-999-023 - Seat Panel 660/710mm
- 5X-0140-999-001 - Commode Bucket & Lid
- 5X-0156-099-030 - Elevating Calf Support, Right Hand
- 5X-0156-099-031 - Elevating Calf Support, Left Hand
- 5X-0156-099-010 - Butterfly Armrests, Pair
- 5X-0150-099-010/K - Straight Armrests, Pair



5X-0150-061-000

Item	Description	Overall Dimensions (w x d x h)	Weight
Standard Armrests			
5X-0150-061-000	Bariatric Mobile Shower / Commode Chair - Standard Armrests, 610mm	670 x 1120 x 990mm	27.0kg
5X-0150-071-000	Bariatric Mobile Shower / Commode Chair - Standard Armrests, 710mm	770 x 1120 x 990mm	27.5kg
Butterfly Armrests			
5X-0151-061-000	Bariatric Mobile Shower / Commode Chair - Butterfly Armrests, 610mm	840 x 1120 x 990mm	27.5kg
5X-0151-071-000	Bariatric Mobile Shower / Commode Chair - Butterfly Armrests, 710mm	940 x 1120 x 990mm	28.0kg



Shower Chair at Maximum Tilt

5X-0155-066-000



Handset to Tilt Chair

Bariatric Shower Chair - Tilt

Features

- Suitable for showering or toileting (supplied with a bucket & lid)
- Powder coated chromium molybdenum steel frame
- 32-degree tilt positioning (battery operation - up to 21 cycles from one charge)
- Supplied with one removable battery & charger (battery must be removed from the unit when charging)
- Rotating & removable straight armrests to assist access (optional butterfly armrests)
- Open back to allow easy sling access & assist positioning
- Polyurethane moulded seat, back & adjustable headrest
- Seat supplied with a removable lid
- Seat panel removable for cleaning
- Long open hole in seat (220mm at the widest point)
- Optional deep bucket is removable from the front or back of the chair
- Side/width adjustable polyurethane moulded footrests, 100kg capacity (optional elevating calf supports)
- 150mm swivel castors, 2 off braking
- Maximum capacity 325kg

Dimensions (w x d x h)

- Seat Width - 660mm
- Seat Height - 510mm
- Seat Depth - 420-480-540mm
- Backrest Height - 530mm

Standard Colours

- Paint - White
- Polyurethane - Blue

Options

- 5X-0150-999-023 - Seat Panel 660/710mm
- 5X-0140-999-001 - Commode Bucket & Lid
- 5X-0156-099-030 - Elevating Calf Support, Right Hand
- 5X-0156-099-031 - Elevating Calf Support, Left Hand
- 5X-0156-099-010 - Butterfly Armrests, Pair
- 5X-0150-099-010/K - Straight Armrests, Pair

Item	Description	Overall Dimensions (w x d x h)	Weight
5X-0155-066-000	Bariatric Shower Chair Tilt - Standard Armrests, 660mm	740 x 1400 x 1000mm	59.0kg

Bariatric Shower Chair - Rise & Tilt

Features

- Suitable for showering or toileting (supplied with a bucket & lid)
- Powder coated chromium molybdenum steel frame
- Height adjustable from 450-1000mm whilst tilting the user, 20 degrees in the highest position
- Battery operation - up to 21 cycles from one charge
- Supplied with one removable battery & charger (battery must be removed from the unit when charging)
- Rotating & removable straight armrests to assist access (optional butterfly armrests)
- Open back to allow easy sling access & assist positioning
- Polyurethane moulded seat, back & adjustable headrest
- Seat supplied with a removable lid
- Seat panel removable for cleaning
- Long open hole in seat (220mm at the widest point)
- Optional deep bucket is removable from the front or back of the chair
- Side/width adjustable polyurethane moulded footrests, 100kg capacity (optional elevating calf supports)
- 150mm swivel castors, all braking
- Maximum capacity 325kg

Dimensions (w x d x h)

- Seat Width - 660mm
- Seat Height - 450-1000mm
- Seat Depth - 420-480-540mm
- Backrest Height - 240-530mm

Standard Colours

- Paint - White
- Polyurethane - Blue

Options

- 5X-0150-999-023 - Seat Panel 660/710mm
- 5X-0140-999-001 - Commode Bucket & Lid
- 5X-0156-099-030 - Elevating Calf Support, Right Hand
- 5X-0156-099-031 - Elevating Calf Support, Left Hand
- 5X-0156-099-010 - Butterfly Armrests, Pair
- 5X-0150-099-010/K - Straight Armrests, Pair



Handset to Tilt Chair



Shower Chair at Maximum Tilt

5X-0157-066-000

Item	Description	Overall Dimensions (w x d x h)	Weight
5X-0157-066-000	Bariatric Shower Chair Rise & Tilt - Standard Armrests, 660mm	740 x 1400 x 1000mm	46.0kg



5X-0142-061-000

Bariatric Shower / Commode Chair

Features

- Suitable for showering or toileting (supplied with a bucket & lid)
- Powder coated chromium molybdenum steel frame
- Available in two widths 610/710mm
- Seat height adjustable 420-550mm
- Long armrests to assist access
- Open back to allow easy sling access & assist positioning
- Polyurethane moulded seat & back
- Seat supplied with a removable lid
- Seat panel removable for cleaning
- Long open hole in seat (220mm at the widest point)
- Optional deep bucket is removable from the front or back of the chair
- Maximum capacity 325kg

Dimensions (w x d x h)

- Seat Width - 610/710mm
- Seat Height - 420-550mm
- Seat Depth - 400-520mm

Standard Colours

- Paint - White
- Polyurethane - Blue

Options

- 5X-0150-999-022 - Seat Panel 610mm
- 5X-0150-999-023 - Seat Panel 660/710mm
- 5X-0140-999-001 - Commode Bucket & Lid

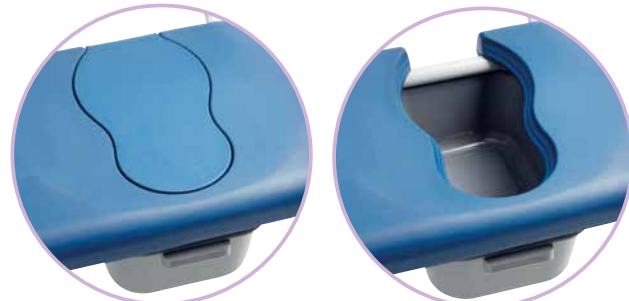

Removable Lid

Item	Description	Overall Dimensions (w x d x h)	Weight
5X-0142-061-000	Bariatric Shower / Commode Chair - 610mm	730 x 1010 x 790 - 940mm	15.0kg
5X-0142-071-000	Bariatric Shower / Commode Chair - 710mm	830 x 1010 x 790 - 940mm	16.0kg

Bariatric High Back Chairs

Features

- Deep CMHR foam
- Vinyl or fabric upholstery
 - Vinyl - Fire retardant & antimicrobial
 - Fabric - Fire retardant
- Black heavy duty steel five star base
- Black heavy duty gas lift
- Black height adjustable soft touch armrests
- Easy lift ratchet height adjustable back
- Independent seat & back mechanism with side tension control
- Maximum capacity 315kg



Replace suffix on the product code with any of the following to select your colour i.e. Bariatric High Back in Lime - 5660XL/VLI

Vinyl - Ambla New Richmond in Colour

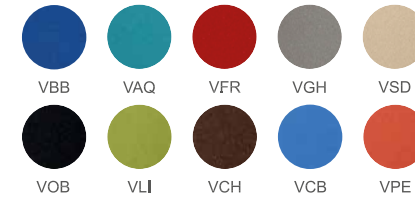

Fabric - Camira Advantage



5660XL/FCT

Item	Description	Overall Dimensions (w x d x h)	Seat Height Adjustment	Weight
5660XL	High Back, Swivel	750 x 750 x 1080-1190mm	425-535mm	29.0kg



Bariatric Chairs

Features

- Deep CMHR foam
- Vinyl or fabric upholstery
 - Vinyl - Fire retardant & antimicrobial
 - Fabric - Fire retardant
- Steel or beech four leg frames
 - Steel - Powder coated
 - Beech - Varnished
- Maximum capacity 315kg

Alternative colours are available at extra cost. Replace suffix on the product code with any of the following to select your colour i.e. Bariatric, Steel Frame in Lime - 5670/VLI

Vinyl - Ambla New Richmond in Colour

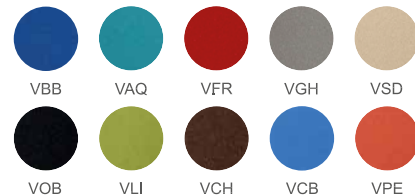

Fabric - Camira Advantage

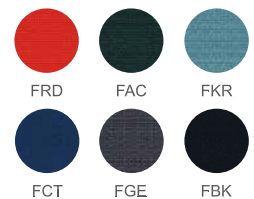

Item	Description	Overall Dimensions (w x d x h)	Seat Height	Weight
5670	Bariatric, Steel Frame	920 x 600 x 885mm	500mm	15.8kg
5671	Bariatric, Beech Frame	844 x 580 x 890mm	490mm	16.0kg

Bariatric Rollator - King

Features

- Maximum capacity 295kg
- Heavy duty powder coated steel frame
- Rigid folding mechanism for efficient storage
- Height adjustable 775-990mm
- Large padded seat with back arch acting as a positive stop (355 x 508mm)
- 200mm cushioned wheels with easy to use hand brakes

Dimensions (w x d x h)

- Overall Dimensions - 710 x 820 x 775-990mm
- Seat - 508 x 355 x 500mm

Standard Colours

- Paint - Red
- Vinyl - Black



Item	Description	Weight
5X-0170-050-000	Rollator - King	15.7kg

Bariatric Walker - Stand Tall

Features

- Maximum capacity 325kg
- Heavy duty powder coated steel frame
- Height adjustable 1000-1300mm
- Low level handgrips to assist the user to stand up
- Full length width adjustable underarm pads
- 100mm swivel castors/125mm braking wheel
- Handlebar operated brakes with locking function

Standard Colours

- Paint - Blue / Silver
- Vinyl - Black

Dimensions (w x d x h)

- Overall Dimensions - 760 x 720 x 1000-1300mm



Item	Description	Weight
5X-0180-076-000	Walker - Stand Tall	23.0kg

Bariatric Training Suit

Features

- Helps educate care staff to the movement difficulties experienced by obese patients
- Foam fitting inner suit
- Unisex design
- Ordinary clothing



Item	Description	Weight
5X-0299-000-010	Training Suit	6.5kg

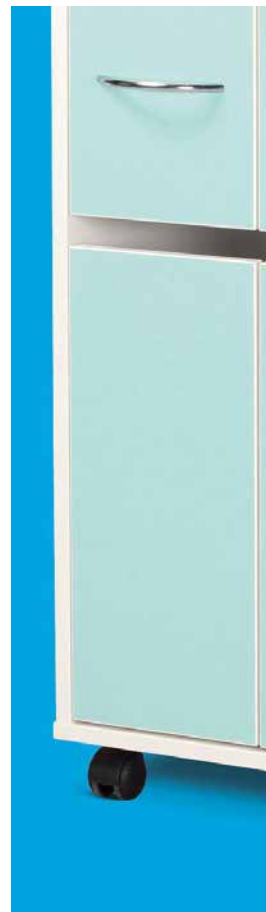

Bedside Cabinets & Overbed Tables

Polymer Bedside Cabinets	20
Bedside Cabinets	22
Bedside Cabinet Options	25
Bedside Cabinet/Wardrobe Combinations	26
Economy Overbed Table	30
Polymer Overbed & Overchair Tables	31
Laminate Overbed & Overchair Tables	32



EBC030

Polymer Bedside Cabinet - Easy Clean

Features

- BS 3962 Part 6:1980 - Assessment of resistance to mechanical damage
- BS EN 12720:2009 - Furniture assessment of surface resistance to cold liquids
- BS EN 12721:2009 - Furniture assessment of surface resistance to wet heat
- BS EN 12722:2009 - Furniture assessment of surface resistance to dry heat
- BS 5852:2006 - Methods of the test for assessment of the ignitability
- BS 4875-7:2006 - Domestic & contract storage furniture
- Developed as part of Design Bugs Out & evaluated by the Department of Health
- Manufactured from recyclable polyethylene offering good surface protection against liquid stains & heat marks
- Open backless design ensures that all areas are accessible
- Smooth surfaces allow for easy & effective cleaning
- Distinct upper, middle & lower zones
 - Upper - Nurse zone with integral rim to contain any spillages. Ideally positioned for staff to use while standing
 - Middle - Patient zone provides storage area for patient use
 - Lower - Patient zone provides shelf for washbowl, footwear etc.
- Drawers can be inserted from either side enabling the cabinet to be positioned on either side of the bed
- Upper & middle drawers can be fitted with an RFID lock, providing secure storage for patient medicines/property*
- Large 100mm twin wheel castors with easily accessible brakes

*cabinets with locks are supplied with one patient card - a programming card will be required per ward/directorate as per hospital policy.

Dimensions (w x d x h)

- Overall Dimensions - 480 x 665 x 1237mm
- Drawers (internal)
 - Upper - 149 x 222 x 217mm
 - Middle - 338 x 491 x 197mm
 - Lower - 338 x 491 x 220mm

Standard Colours

- Body - Grey White
- Drawers - Spearmint

Options

- EBC900 - Patient Card (Blue) - Cabinets with locks are supplied with one patient card
- EBC901 - Staff Card (Green)
- EBC902 - Master Card, Staff (Red)
- EBC910 - Programming Card - Staff Pair (Black)
- 2LOKE134 - Key Fob

Item	Description	Weight
EBC015	Polymer Bedside Cabinet - No Locks	29.0kg
EBC020	Polymer Bedside Cabinet - Upper Drawer with Lock	29.1kg
EBC025	Polymer Bedside Cabinet - Middle Drawer with Lock	29.1kg
EBC030	Polymer Bedside Cabinet - Upper & Middle Drawers with Locks	29.2kg



EBC030

Open backless design allows for easy & effective cleaning. Drawers can be inserted for right & left hand orientation

Lock Cards

Features

- Compatible with battery powered RFID controlled electronic locks
- Credit card size plastic key cards with an embedded contactless RFID chip
- Available as user/staff/master access cards
- A programming card is required for each hospital or ward as per hospital procedure

Overall Dimensions (w x d x h)

- Card - 86 x 54 x 2mm



2LOKE134



Item	Description
EBC900	User Card - Patient (Blue)
EBC901	User Card - Staff (Green)
EBC902	Master Card - Staff (Red)
EBC910	Programming Card - Staff Pair, (Black)
2LOKE134	Key Fob



BC1DPD/BE

BC1C/GW/RPT

Bedside Cabinet - Single Upper Drawer

Features

- Meets BS1765: Part 1: 1990 Specification for general purpose bedside lockers for patients (with exception of door hinges which are more robust & practical)
- Constructed from melamine faced chipboard & laminate
- Upper drawer suitable for the storage of patient's medication or personal effects (fitted with a CAM lock & supplied with 2 keys)
- Optional personal effects drawer provides secure storage for personal possessions (fitted with a CAM lock & supplied with 2 keys)
- Optional electronic push button & RFID locking solutions available for the upper & personal effects drawer (see page 25)
- Lower storage offered through...
 - Cupboard with double doors (adjustable shelf - model dependant)
 - Drawer (recessed shelf - model dependant)
- Choice of two colour schemes...
 - Two Tone - Body grey white. Top, drawer & door fronts available in a range of colours
 - Single Colour - Beech throughout
- 50mm twin-wheel polypropylene castors

Dimensions (w x d x h)

- Overall Dimensions: 485 x 485 x 905mm
- Internal Dimensions...
 - Upper Drawer: 413 x 381 x 182mm
 - Personal Drawer: 413 x 381 x 102mm
 - Lower Drawer: 413 x 381 x 505/297mm
 - Cupboard: 445 x 443 x 537/394mm

Standard Colours

- Two Tone
- Body - Grey White
 - Top / Drawer / Door Fronts - Spearmint
- Single Colour
- Body - Beech
 - Top / Drawer / Door Fronts - Beech

Options

- PL - PS Solo RFID Electronic Lock (upper drawer)
- TL - TESA RFID Electronic Lock (upper drawer)
- CL - Electronic Push Button Lock (upper & personal effects drawer)
- Lock Cards - See page 25
- RPT - Removable Plastic Top
- TH - Towel Holder

Grey White	Beech	Description	Weight
BC1C/GW	BC1C/BE	Single Upper Drawer, Lower Cupboard with Double Doors & Adjustable Shelf	34.0kg
BC1CPD/GW	BC1CPD/BE	Single Upper Drawer, Personal Drawer & Lower Cupboard with Double Doors	35.8kg
BC1D/GW	BC1D/BE	Single Upper Drawer, Lower Drawer with Recessed Shelf	40.4kg
BC1DPD/GW	BC1DPD/BE	Single Upper Drawer, Personal Drawer & Lower Drawer	42.1kg

Alternative Colours Available, Contact Us For Details



Bedside Cabinet - Double Upper Drawer

Features

- Meets BS1765: Part 1: 1990 Specification for general purpose bedside lockers for patients (with exception of door hinges which are more robust & practical)
- Constructed from melamine faced chipboard & laminate
- Upper drawers suitable for the storage of patient's medication or personal effects (1 x fitted with a CAM lock & supplied with 2 keys)
- Optional electronic push button & RFID locking solutions available for either drawer (see page 25)
- Lower storage offered through...
 - Cupboard with double doors (adjustable shelf)
 - Drawer (recessed shelf)
- Choice of two colour schemes...
 - Two Tone - Body grey white. Top, drawer & door fronts available in a range of colours
 - Single Colour - Beech throughout
- 50mm twin-wheel polypropylene castors

Dimensions (w x d x h)

- Overall Dimensions - 485 x 485 x 905mm
- Internal Dimensions...
 - Upper Drawer: 180 x 381 x 182mm
 - Lower Drawer: 413 x 381 x 505mm
 - Cupboard: 445 x 443 x 537mm

Standard Colours

- Two Tone
- Body - Grey White
 - Top / Drawer / Door Fronts - Spearmint
- Single Colour
- Body - Beech
 - Top / Drawer / Door Fronts - Beech

Options

- PL - PS Solo RFID Electronic Lock (upper drawer)
- TL - TESA RFID Electronic Lock (upper drawer)
- CL - Electronic Push Button Lock (upper drawer)
- Lock Cards - See page 25
- RPT - Removable Plastic Top
- TH - Towel Holder

Grey White	Beech	Description	Weight
BC2C/GW	BC2C/BE	Double Upper Drawer, Lower Cupboard with Double Doors & Adjustable Shelf	34.2kg
BC2D/GW	BC2D/BE	Double Upper Drawer, Lower Drawer with Recessed Shelf	40.5kg



BC2D/BE

BC2C/GW

Alternative Colours Available, Contact Us For Details



Bedside Cabinet - Upper Section & Rear Side Doors



BC3CPD/BE



BC3C/GW

Features

- Meets BS1765: Part 1: 1990 Specification for general purpose bedside lockers for patients (with exception of door hinges which are more robust & practical)
- Constructed from melamine faced chipboard & laminate
- Upper section suitable for the storage of patient's medication or personal effects (fitted with a CAM lock & supplied with 2 keys)
- Rear side doors allow access to contents
- Optional personal effects drawer provides secure storage for personal possessions (fitted with a CAM lock & supplied with 2 keys)
- Optional electronic push button & RFID locking solutions available for the upper section & personal effects drawer (see page 25)
- Lower storage offered through...
 - Cupboard with double doors (adjustable shelf - model dependant)
 - Drawer (recessed shelf - model dependant)
- Choice of two colour schemes...
 - Two Tone - Body grey white. Top, drawer & door fronts available in a range of colours
 - Single Colour - Beech throughout
- 50mm twin-wheel polypropylene castors

Dimensions (w x d x h)

- Overall Dimensions: 485 x 485 x 905mm
- Internal Dimensions...
 - Upper Section: 445 x 135 x 249mm
 - Rear Side Section: 290 x 445 x 249mm
 - Personal Drawer: 413 x 381 x 102mm
 - Lower Drawer: 413 x 381 x 505/297mm
 - Cupboard: 445 x 443 x 537/394mm

Options

- PL - PS Solo RFID Electronic Lock (upper drawer)
- TL - TESA RFID Electronic Lock (upper drawer)
- CL - Electronic Push Button Lock (upper & personal effects drawer)
- Lock Cards - See page 25
- RPT - Removable Plastic Top
- TH - Towel Holder

Standard Colours

- Two Tone
 - Body - Grey White
 - Top / Drawer / Door Fronts - Spearmint
- Single Colour
 - Body - Beech
 - Top / Drawer / Door Fronts - Beech

Alternative Colours Available, Contact Us For Details



Grey White	Beech	Description	Weight
BC3C/GW	BC3C/BE	Upper Section, Lower Cupboard with Double Doors & Adjustable Shelf	31.8kg
BC3CPD/GW	BC3CPD/BE	Upper Section, Personal Drawer & Lower Cupboard with Double Doors	33.5kg
BC3D/GW	BC3D/BE	Upper Section, Lower Drawer with Recessed Shelf	38.1kg
BC3DPD/GW	BC3DPD/BE	Upper Section, Personal Drawer & Lower Drawer	39.8kg

Electronic Push Button & RFID Locking Solutions

Through either electronic push button or contactless RFID, we are able to offer a secure locking solution to suit your specific requirements. The table below highlights the key features of each system - for more information please contact our customer services team.



	Electronic Push Button Lock	TESA RFID Electronic Lock	PS Solo RFID Electronic Lock
RFID Compatibility	-	Mifare - 13.56 mHz	EM4200, EM4450, Hitag - 125 kHz
Levels of User Administration	4 - Master / Nurse / User / Technician	3 - Master / Nurse / User	3 - Master / Nurse / User
Operation Modes	Private Use Public Use ^a	Private Use Public Use ^b	Private Use Public Use ^b
Audit Trail	No	No	No
Retro Fit Into Existing Cylinders	Yes	Yes - Dependent on cabinet type	No
Programming	10 Button Keypad & # Button	Programming Card	Programming Card
Openings On One Battery	15,000	15,000	20,000
Low Battery Warning	Yes	Yes	Yes
Batteries	2 x AAA (1.5V)	3 x AA (1.5v)	1 x CR2 (3V)
Low Battery Override	9v Battery Across LED's (+/-) & Master Code	Yes - Using an external plug in power supply	Lock Will Fail Open
Compatible with Abloy® Cliq™ Remote	No	Yes - Using an RFID Chip inserted in Cliq™ key	Yes - Using a combined 125 kHz / 13.56mHz card or 13.56mHz RFID sticker applied to existing 125kHz cards

Operation Modes

1. Private Use - This is the most common function & used where the same code will be repeatedly used
2. Public Use
 - a. In this mode the lock operates with a single user code. The user enters their own personal four-digit code. This locks the lock. The same code is entered once only to open the lock before being erased & ready for the next new user
 - b. In this mode the lock operates with a single user card. The presented user card locks the lock. The same user card will reopen the lock ready for the next user

Towel Holder

Features

- Self-adhesive towel holder
- Supplied for customer to fit



Item	Description	Weight
TH	Towel Holder	0.1kg

Removable Plastic Top

Features

- Contoured plastic top
- Raised lip on three sides reduces misplacement of objects
- Clips to the top of the bedside cabinet
- Removable to assist cleaning
- Not compatible with bedside cabinets fitted with wardrobes



Item	Description	Weight
RPT	Removable Plastic Top	0.8kg

Lock Cards

Features

- Compatible with TESA & PS Solo battery powered RFID controlled electronic locks
- Credit card size plastic key cards with an embedded contactless RFID chip
- Available as programming/staff/patient cards
- A programming card is required for each hospital or ward as per hospital procedure
- A patient card is supplied with the cabinets

Item	Description
RFID020/P	Programming Card
RFID020/S	Staff Card
RFID020/U	Patient Card
RFID020/SF	Staff Fob
RFID020/PF	Patient Fob



BCC1DWR/BE

Alternative Colours Available, Contact Us For Details



Compact Bedside Cabinet / Wardrobe Combination - Single Upper Drawer



BCC1CWL/GW

Features

- Meets BS1765: Part 1: 1990 Specification for general purpose bedside lockers for patients (with exception of door hinges which are more robust & practical)
- Constructed from melamine faced chipboard & laminate
- Upper drawer suitable for the storage of patient's medication or personal effects (fitted with a CAM lock & supplied with 2 keys)
- Optional electronic push button & RFID locking solutions available for the upper drawer (see page 25)
- Lower storage offered through...
 - Cupboard with double doors (adjustable shelf)
 - Drawer (recessed shelf)
- Choice of two colour schemes...
 - Two Tone - Body grey white. Top, drawer & door fronts available in a range of colours
 - Single Colour - Beech throughout
- Wardrobe supplied with a hanging rail, available right/left hand opening
- 50mm twin-wheel polypropylene castors

Dimensions (w x d x h)

- Overall Dimensions: 633 x 489 x 1420mm
- Internal Dimensions...
 - Upper Drawer: 328 x 381 x 182mm
 - Lower Drawer: 328 x 381 x 505mm
 - Cupboard: 360 x 443 x 537mm
 - Wardrobe: 215 x 443 x 1420mm

Options

- PL - PS Solo RFID Electronic Lock (upper drawer)
- TL - TESA RFID Electronic Lock (upper drawer)
- CL - Electronic Push Button Lock (upper & personal effects drawer)
- Lock Cards - See page 25
- TH - Towel Holder

Standard Colours

- Two Tone
- Body - Grey White
 - Top / Drawer / Door Fronts - Spearmint
- Single Colour
- Body - Beech
 - Top / Drawer / Door Fronts - Beech

Grey White	Beech	Description	Weight
Right Hand			
BCC1CWR/GW	BCC1CWR/BE	Single Upper Drawer, Lower Cupboard with Double Doors & Adjustable Shelf	50.6kg
BCC1DWR/GW	BCC1DWR/BE	Single Upper Drawer, Lower Drawer with Recessed Shelf	56.9kg
Left Hand			
BCC1CWL/GW	BCC1CWL/BE	Single Upper Drawer, Lower Cupboard with Double Doors & Adjustable Shelf	50.6kg
BCC1DWL/GW	BCC1DWL/BE	Single Upper Drawer, Lower Drawer with Recessed Shelf	56.9kg

Bedside Cabinet / Wardrobe Combination - Single Upper Drawer

Features

- Meets BS1765: Part 1: 1990 Specification for general purpose bedside lockers for patients (with exception of door hinges which are more robust & practical)
- Constructed from melamine faced chipboard & laminate
- Upper drawer suitable for the storage of patient's medication or personal effects (fitted with a CAM lock & supplied with 2 keys)
- Optional personal effects drawer provides secure storage for personal possessions (fitted with a CAM lock & supplied with 2 keys)
- Optional electronic push button & RFID locking solutions available for the upper & personal effects drawer (see page 25)
- Lower storage offered through...
 - Cupboard with double doors (adjustable shelf)
 - Drawer (recessed shelf - model dependant)
- Choice of two colour schemes...
 - Two Tone - Body grey white. Top, drawer & door fronts available in a range of colours
 - Single Colour - Beech throughout
- Wardrobe supplied with a hanging rail, available right/left hand opening
- 50mm twin-wheel polypropylene castors

Dimensions (w x d x h)

- Overall Dimensions: 718 x 489 x 1420mm
- Internal Dimensions...
 - Upper Drawer: 413 x 381 x 182mm
 - Personal Drawer: 413 x 381 x 102mm
 - Lower Drawer: 413 x 381 x 505/297mm
 - Cupboard: 445 x 443 x 537/394mm
 - Wardrobe: 215 x 443 x 1420mm

Options

- PL - PS Solo RFID Electronic Lock (upper drawer)
- TL - TESA RFID Electronic Lock (upper drawer)
- CL - Electronic Push Button Lock (upper & personal effects drawer)
- Lock Cards - See page 25
- TH - Towel Holder

Grey White	Beech	Description	Weight
Right Hand			
BC1CWR/GW	BC1CWR/BE	Single Upper Drawer, Lower Cupboard with Double Doors & Adjustable Shelf	54.5kg
BC1CPDWR/GW	BC1CPDWR/BE	Single Upper Drawer, Personal Drawer & Lower Cupboard with Double Doors	56.2kg
BC1DWR/GW	BC1DWR/BE	Single Upper Drawer, Lower Drawer with Recessed Shelf	60.8kg
BC1DPDWR/GW	BC1DPDWR/BE	Single Upper Drawer, Personal Drawer & Lower Drawer	62.5kg
Left Hand			
BC1CWL/GW	BC1CWL/BE	Single Upper Drawer, Lower Cupboard with Double Doors & Adjustable Shelf	54.5kg
BC1CPDWL/GW	BC1CPDWL/BE	Single Upper Drawer, Personal Drawer & Lower Cupboard with Double Doors	56.2kg
BC1DWL/GW	BC1DWL/BE	Single Upper Drawer, Lower Drawer with Recessed Shelf	60.8kg
BC1DPDWL/GW	BC1DPDWL/BE	Single Upper Drawer, Personal Drawer & Lower Drawer	62.5kg

Standard Colours

- Two Tone
- Body - Grey White
 - Top / Drawer / Door Fronts - Spearmint
- Single Colour
- Body - Beech
 - Top / Drawer / Door Fronts - Beech



BC1CPDWR/GW

Alternative Colours Available, Contact Us For Details





BC2CWR/BE

Bedside Cabinet / Wardrobe Combination - Double Upper Drawer



BC2CWL/GW

Features

- Meets BS1765: Part 1: 1990 Specification for general purpose bedside lockers for patients (with exception of door hinges which are more robust & practical)
- Constructed from melamine faced chipboard & laminate
- Upper drawers suitable for the storage of patient's medication or personal effects (1 x fitted with a CAM lock & supplied with 2 keys)
- Optional electronic push button & RFID locking solutions available for either drawer (see page 25)
- Lower storage offered through...
 - Cupboard with double doors (adjustable shelf)
 - Drawer (recessed shelf)
- Choice of two colour schemes...
 - Two Tone - Body grey white. Top, drawer & door fronts available in a range of colours
 - Single Colour - Beech throughout
- Wardrobe supplied with a hanging rail, available right/left hand opening
- 50mm twin-wheel polypropylene castors

Dimensions (w x d x h)

- Overall Dimensions: 718 x 489 x 1420mm
- Internal Dimensions...
 - Upper Drawer: 180 x 381 x 182mm
 - Lower Drawer: 413 x 381 x 505mm
 - Cupboard: 445 x 443 x 537mm
 - Wardrobe: 215 x 443 x 1420mm

Options

- PL - PS Solo RFID Electronic Lock (upper drawer)
- TL - TESA RFID Electronic Lock (upper drawer)
- CL - Electronic Push Button Lock (upper & personal effects drawer)
- Lock Cards - See page 25
- TH - Towel Holder

Standard Colours

- Two Tone
 - Body - Grey White
 - Top / Drawer / Door Fronts - Spearmint
- Single Colour
 - Body - Beech
 - Top / Drawer / Door Fronts - Beech

Grey White	Beech	Description	Weight
Right Hand			
BC2CWR/GW	BC2CWR/BE	Double Upper Drawer, Lower Cupboard with Double Doors & Adjustable Shelf	55.0kg
BC2DWR/GW	BC2DWR/BE	Double Upper Drawer, Lower Drawer with Recessed Shelf	61.3kg
Left Hand			
BC2CWL/GW	BC2CWL/BE	Double Upper Drawer, Lower Cupboard with Double Doors & Adjustable Shelf	55.0kg
BC2DWL/GW	BC2DWL/BE	Double Upper Drawer, Lower Drawer with Recessed Shelf	61.3kg

Alternative Colours Available, Contact Us For Details



Bedside Cabinet / Wardrobe Combination - Upper Section & Rear Side Doors

Features

- Meets BS1765: Part 1: 1990 Specification for general purpose bedside lockers for patients (with exception of door hinges which are more robust & practical)
- Constructed from melamine faced chipboard & laminate
- Upper section suitable for the storage of patient's medication or personal effects (fitted with a CAM lock & supplied with 2 keys)
- Rear side doors allow access to contents
- Optional personal effects drawer provides secure storage for personal possessions (fitted with a CAM lock & supplied with 2 keys)
- Optional electronic push button & RFID locking solutions available for the upper section & personal effects drawer (see page 25)
- Lower storage offered through...
 - Cupboard with double doors (adjustable shelf - model dependant)
 - Drawer (recessed shelf - model dependant)
- Choice of two colour schemes...
 - Two Tone - Body grey white. Top, drawer & door fronts available in a range of colours
 - Single Colour - Beech throughout
- Wardrobe supplied with a hanging rail, available right/left hand opening
- 50mm twin-wheel polypropylene castors

Dimensions (w x d x h)

- Overall Dimensions: 718 x 489 x 1420mm
- Internal Dimensions...
 - Upper Section: 445 x 135 x 249mm
 - Rear Side Section: 290 x 445 x 249mm
 - Personal Drawer: 413 x 381 x 102mm
 - Lower Drawer: 413 x 381 x 505/297mm
 - Cupboard: 445 x 443 x 537/394mm
 - Wardrobe: 215 x 443 x 1420mm

Options

- PL - PS Solo RFID Electronic Lock (upper drawer)
- TL - TESA RFID Electronic Lock (upper drawer)
- CL - Electronic Push Button Lock (upper & personal effects drawer)
- Lock Cards - See page 25
- TH - Towel Holder

Standard Colours

- Two Tone
 - Body - Grey White
 - Top / Drawer / Door Fronts - Spearmint
- Single Colour
 - Body - Beech
 - Top / Drawer / Door Fronts - Beech



BC3CPDWR/GW

Grey White	Beech	Description	Weight
Right Hand			
BC3CWR/GW	BC3CWR/BE	Upper Section, Lower Cupboard with Double Doors & Adjustable Shelf	52.1kg
BC3CPDWR/GW	BC3CPDWR/BE	Upper Section, Personal Drawer & Lower Cupboard with Double Doors	53.8kg
BC3DWR/GW	BC3DWR/BE	Upper Section, Lower Drawer with Recessed Shelf	58.4kg
BC3DPDWR/GW	BC3DPDWR/BE	Upper Section, Personal Drawer & Lower Drawer	60.1kg
Left Hand			
BC3CWL/GW	BC3CWL/BE	Upper Section, Lower Cupboard with Double Doors & Adjustable Shelf	52.1kg
BC3CPDWL/GW	BC3CPDWL/BE	Upper Section, Personal Drawer & Lower Cupboard with Double Doors	53.8kg
BC3DWL/GW	BC3DWL/BE	Upper Section, Lower Drawer with Recessed Shelf	58.4kg
BC3DPDWL/GW	BC3DPDWL/BE	Upper Section, Personal Drawer & Lower Drawer	60.1kg

Alternative Colours Available, Contact Us For Details





Economy Overbed Table

Features

- Cantilever design
- Height/angle adjustable using two hand wheels (650-1080mm)
- Sliding top to allow for central positioning over bed (190mm)
- All round raised plastic lip
- Can be stacked when not in use
- 50mm twin wheel braking castors
- Maximum load 8kg

Dimensions (w x d x h)

- Overall Dimensions - 630 x 375 x 650/1080mm

Standard Colours

- Paint - White
- Laminate Top - Beech



Top extends to assist positioning

Item	Description	Weight
BT/12/A	Economy Overbed Table	9.0kg

Overbed & Overchair Table - Polymer, Easy Clean

eClean™

Features

- BS 2483: 1977 Specification for overbed tables (selected tests)
- Finish Performance Tests (FIRA Standard 6250 2005)
 - BS 3962-6: 1980 Methods of test for finishes for wooden furniture
 - BS EN 12720: 2009 + A1: 2013 Assessment of surface resistance to cold liquids
 - BS EN 12721: 2009 + A1: 2013 Assessment of surface resistance to wet heat
 - BS EN 12722: 2009 + A1: 2013 Assessment of surface resistance to dry heat
- Height adjustable using a gas damper (760-1070mm)
- Extruded aluminium column provides a smooth linear height adjustment
- Safety feature prevents trapping of the patient between the bed & table
- Cantilever tubular base available as...
 - C shaped suitable for use with beds & chairs
 - Straight leg suitable for use with beds
- Recyclable polypropylene top with defined edges & contours ensures that all key surfaces are accessible & enables the table to be easily & effectively cleaned
- Raised lip on table reduces misplacement of objects & contains spillages
- 50mm twin wheel cushioned castors
- Maximum load 25kg

Dimensions (w x d x h)

- Table Top - 880 x 440mm

Options

- B - Braking Castors (x 2)

Standard Colours

- Top
- Grey White
- Upper Extrusion
- Spearmint
- Lower Extrusion/Base
- Grey White

Alternative Upper Extrusion Colours Available, Contact Us For Details



Item	Description	Overall Dimensions (w x d x h)	Weight
OBP/SP/S	Height Adjustable, Polymer, Easy Clean	895 x 440 x 760 - 1070mm	14.0kg
OCP/SP/S	Height Adjustable, Polymer, Easy Clean	918 x 440 x 760 - 1070mm	13.5kg





Overbed & Overchair Table - Laminate

Features

- BS 2483: 1977 Specification for overbed tables (selected tests)
- BS EN 438-2: 2016 High-pressure decorative laminates (HPL). Sheets based on thermosetting resins (usually called laminates). Determination of properties
- Height adjustable using a gas damper (735-1045mm)
- Extruded aluminium column provides a smooth linear height adjustment
- Safety feature prevents trapping of the patient between the bed & table
 - Cantilever tubular base available as...
 - C shaped suitable for use with beds & chairs
- Straight leg suitable for use with beds
- Laminate top with varnished edges available in three configurations
 - Flat top
 - One varnished beech lip
 - Three varnished beech lips
- 50mm twin wheel polypropylene castors
- Maximum load 25kg

Dimensions (w x d x h)

- Table Top - 880 x 395mm
- Overbed Table - 895 x 440 x 735-1045mm
- Overchair Table - 918 x 440 x 735-1045mm

Options

- B - Braking Castors (x 2)

Standard Colours

Top - Grey White or Beech
 Upper Extrusion - Spearmint or Grey White
 Lower Extrusion/Base - Grey White

Top - Grey White / Upright - Spearmint

Item	Description	Weight
Overbed Tables		
OBL/GW0/SP/S	Height Adjustable, Laminate, Flat Top	14.5kg
OBL/GW1/SP/S	Height Adjustable, Laminate, One Lip	15.4kg
OBL/GW3/SP/S	Height Adjustable, Laminate, Three Lips	15.8kg
Overchair Tables		
OCL/GW0/SP/S	Height Adjustable, Laminate, Flat Top	14.1kg
OCL/GW1/SP/S	Height Adjustable, Laminate, One Lip	15.0kg
OCL/GW3/SP/S	Height Adjustable, Laminate, Three Lips	15.4kg

Top - Beech / Upright - Grey White

Item	Description	Weight
Overbed Tables		
OBL/BE0/GW/S	Height Adjustable, Laminate, Flat Top	14.5kg
OBL/BE1/GW/S	Height Adjustable, Laminate, One Lip	15.4kg
OBL/BE3/GW/S	Height Adjustable, Laminate, Three Lips	15.8kg
Overchair Tables		
OCL/BE0/GW/S	Height Adjustable, Laminate, Flat Top	14.1kg
OCL/BE1/GW/S	Height Adjustable, Laminate, One Lip	15.0kg
OCL/BE3/GW/S	Height Adjustable, Laminate, Three Lips	15.4kg



Alternative Upper Extrusion Colours Available, Contact Us For Details





Caretray Trolleys & Racks

Features	36
Disassembly & Cleaning	38
Stainless Steel, Low Level Trolleys	40
Stainless Steel, Standard Level Trolleys	42
Stainless Steel, High Level Trolleys	44
Stainless Steel, Mobile Racks	46
Stainless Steel, Static Racks	48
Mild Steel, Low Level Trolleys	50
Mild Steel, Standard Level Trolleys	52
Mild Steel, High Level Trolleys	54
Mild Steel, Mobile Racks	56
Mild Steel, Static Racks	58
Caretray Trolley Options	60

Caretray Trolley Features

Carerails

- Fitted to both sides of the trolley, compatible with a wide range of accessories

Side Panels

- One piece moulded side panels
- Smooth surfaces, rounded edges & contours assists cleaning (compatible with steam cleaning)
- Runners with positive stops prevent trays from being accidentally withdrawn (symmetrical design allows tray insertion from either side)

Easy Clean

- One piece mouldings used throughout
- Smooth surfaces, rounded edges & contours assists cleaning
- Steam cleaning compatible
- Quick & easy tool-less disassembly assists thorough or deep cleaning programmes



Top

- One piece moulded top prevents ingress of dirt
- Smooth surfaces, rounded edges & contours assists cleaning (compatible with steam cleaning)
- Raised edges on three sides provides defined grab points to act as push handles, whilst an integral rim at the front contains spillages
- Maximum load of 30kg

Frame

- Frames are fully welded eliminating any gaps
- Available in either 304 grade stainless steel or mild steel that is blast finished & powder coated in a durable epoxy polyester paint



304 grade stainless steel

Ring Buffers

- Ring buffers offer protection to both the trolley & fabric of the building
- Smooth surfaces assist cleaning

Trays - Dividers - Plastic Clip On Label Cover - Labels

- Translucent, impact-resistant trays & dividers
- Smooth surfaces, rounded edges & contours assists cleaning (compatible with steam cleaning & able to withstand high temperature machine washing)
- Trays feature an integral handle with plastic clip on label cover, (suitable for use with our perforated coloured label strips)
- Trays are available in 100 or 150mm depths & can be subdivided in both length & width using simple slot in dividers
- Each tray is supplied with 4 removable dividers (2 x long & 2 x short)
- Maximum load of 5kg



Castors

- Trolleys are fitted with 100mm pressed steel castors
- Two braking castors are fitted as standard
- Optional 100mm polymer castors offer reduced rolling resistance making the trolley easier to manoeuvre, lower noise levels & smooth surfaces to assist cleaning



Optional Polymer Castors

Doors & Back Panel

- Solid grade laminate doors & back panel
- Smooth surfaces, rounded edges & contours assists cleaning (compatible with steam cleaning)
- 270 degree opening hinges allow the doors to fold flat against the sides of the trolley
- Three locking options...



CAM with Winged Handle



Security Seal



Electronic Push Button Lock



Disassembly & Cleaning

The design of the trolley allows for quick & easy tool-less disassembly providing access for all areas when conducting thorough or deep cleaning programmes. The simple guide below illustrates the disassembly & re-assembly process...



Remove Trays

Remove the trays from the unit



Remove Top

The top is held in place with two thumb screws. These are located on the underside of the top. Once these are removed the top can be removed with a firm tug



Remove Back Panel (if fitted)

Once the top has been removed the back panel can be lifted clear of the cross members on the rear of the frame



Remove Side Panels

The side panels can now be removed by lifting off of the positioning inserts. Double height trolleys require thumb screws at the top of the lower panel to be removed.



Clean

The frame, side panels & top can now be cleaned



Reassemble

The trolley can now be re-assembled by repeating the steps in reverse

Caretray Trolleys - Stainless Steel, Low Level, Single & Double Column

Features

- Low level single & double column easy clean procedure trolleys. Height makes it suitable to be stored under bench
- Designed for quick & easy complete disassembly when conducting thorough or deep cleaning programmes (including steam cleaning)
- Seamlessly welded one piece frame from 304 grade stainless steel (requires no on-site assembly)
- One piece moulded top with raised edges on three sides & integral rim at the front to contain any spillages (max load 30kg)
- One piece moulded side panels incorporate runners with positive stops, preventing trays from being accidentally withdrawn
- Carerail fitted to each side of the trolley to support a wide range of accessories (see options)
- 100/150mm deep translucent high impact plastic trays feature an integral handle with plastic clip on label cover, (max load per tray 5kg)
- Each trolley is supplied with perforated coloured label strips (white, blue, green, yellow & red)
- Trays can be subdivided in both length & width using simple slot in dividers (each tray supplied with 2 x long & 2 x short dividers)
- Polyurethane ring buffers offer protection to both the trolley & fabric of the building; smooth surfaces assist cleaning
- 100mm pressed steel castors, 2 off braking

Dimensions (w x d x h)

- Single Column - 550 x 550 x 807mm
- Double Column - 1005 x 550 x 807mm
- Plastic Top
 - Single Column - 455 x 455 (internal) at height 782mm
 - Double Column - 915 x 455 (internal) at height 782mm
- Trays
 - Shallow Tray - 355 x 405 x 100mm (internal)
 - Deep Tray - 355 x 405 x 150mm (internal)

Item	Description	Weight
CTS1/08/1S2D	1 x 100mm, 2 x 150mm Trays	21.2kg
CTS1/08/3D	3 x 150mm Trays	21.5kg
CTS1/08/3S1D	3 x 100mm, 1 x 150mm Trays	22.3kg
CTS1/08/4S	4 x 100mm Trays	21.9kg



CTS1/08/3S1D



CTS1/08/3S1D - Shown with optional CT/WF, CT/AGH & GMBH/15



Easy disassembly - see page 38

Options

- CT/AGH - Alcohol Gel Holder
- CT/AIR - Airway Tube Holder
- CT/BIN - Debris Bin & Bracket
- CT/DH/A4 - Document Holder, A4
- CT/CR2 & CT/CR5 - Catheter Racks
- CT/CYD - Cylinder Holder - C/CD/D Size
- Single & Double Doors - See page 60
- CT/FS - Flat Shelf - Removable
- CT/IV - Infusion Pole & Bracket
- CT/WF - Work Flap
- GMBH/15 - Glove / Mask Box Holder - One Box, 15mm Hook
- SBH/15 - Sharps Box Holder - One Box, 15mm Hook
- CT/SBB/15 - Sharps Box Bracket - Universal (Daniels / Frontier / Sharpak)
- Polymer Castors - See page 69



CTS2/08/4S3D

Optional Polymer Castors

- Easier to manoeuvre -
 - Reduced noise levels -
 - Easy to clean -
- See page 69



CTS2/08/4S3D - Shown with optional CT/IV, GMBH/15 & CT/AGH

Item	Description	Weight
CTS2/08/3S4D	3 x 100mm, 4 x 150mm Trays	37.3kg
CTS2/08/4S3D	4 x 100mm, 3 x 150mm Trays	36.9kg
CTS2/08/6D	6 x 150mm Trays	36.5kg
CTS2/08/6S2D	6 x 100mm, 2 x 150mm Trays	38.1kg
CTS2/08/7S1D	7 x 100mm, 1 x 150mm Trays	37.7kg
CTS2/08/8S	8 x 100mm Trays	37.3kg

Caretray Trolleys - Stainless Steel, Standard Level, Single & Double Column



CTS1/10/3S2D



CTS1/10/3S2D - Shown with optional CT/IV, CT/CR2, GMBH/15 & CT/AGH



Easy disassembly - see page 38

Features

- Standard level single & double column easy clean procedure trolleys
- Designed for quick & easy complete disassembly when conducting thorough or deep cleaning programmes (including steam cleaning)
- Seamlessly welded one piece frame from 304 grade stainless steel (requires no on-site assembly)
- One piece moulded top with raised edges on three sides and integral rim at the front to contain any spillages (max load 30kg)
- One piece moulded side panels incorporate runners with positive stops, preventing trays from being accidentally withdrawn
- Carerails fitted to each side of the trolley to support a wide range of accessories (see options)
- 100/150mm deep translucent high impact plastic trays feature an integral handle with plastic clip on label cover, (max load per tray 5kg)
- Each trolley is supplied with perforated coloured label strips (white, blue, green, yellow & red)
- Trays can be subdivided in both length & width using simple slot in dividers (each tray supplied with 2 x long & 2 x short dividers)
- Polyurethane ring buffers offer protection to both the trolley & fabric of the building; smooth surfaces assist cleaning
- 100mm pressed steel castors, 2 off braking

Dimensions (w x d x h)

- Single Column - 550 x 550 x 993mm
- Double Column - 1005 x 550 x 993mm
- Plastic Top
 - Single Column - 455 x 455 (internal) at height 968mm
 - Double Column - 915 x 455 (internal) at height 968mm
- Trays
 - Shallow Tray - 355 x 405 x 100mm (internal)
 - Deep Tray - 355 x 405 x 150mm (internal)

Item	Description	Weight
CTS1/10/1S3D	1 x 100mm, 3 x 150mm Trays	27.9kg
CTS1/10/3S2D	3 x 100mm, 2 x 150mm Trays	29.0kg
CTS1/10/4D	4 x 150mm Trays	28.3kg
CTS1/10/4S1D	4 x 100mm, 1 x 150mm Trays	28.7kg
CTS1/10/6S	6 x 100mm	29.8kg



CTS2/10/6S4D

Optional Polymer Castors
 - Easier to manoeuvre -
 - Reduced noise levels -
 - Easy to clean -
 See page 69



CTS2/10/6S4D - Shown with optional CT/IV, CT/CR2, GMBH/15 & CT/AGH

Item	Description	Weight
CTS2/10/3S6D	3 x 100mm, 6 x 150mm Trays	46.6kg
CTS2/10/4S5D	4 x 100mm, 5 x 150mm Trays	46.2kg
CTS2/10/5S4D	5 x 100mm, 4 x 150mm Trays	45.9kg
CTS2/10/6S4D	6 x 100mm, 4 x 150mm Trays	47.3kg
CTS2/10/8D	8 x 150mm Trays	45.8kg
CTS2/10/8S2D	8 x 100mm, 2 x 150mm Trays	46.6kg

Options

- CT/AGH - Alcohol Gel Holder
- CT/AIR - Airway Tube Holder
- CT/BIN - Debris Bin & Bracket
- CT/DH/A4 - Document Holder, A4
- CT/CR2 & CT/CR5 - Catheter Racks
- CT/CYD - Cylinder Holder - C/CD/D Size
- Single & Double Doors - See page 60
- CT/FS - Flat Shelf - Removable
- CT/IV - Infusion Pole & Bracket
- CT/WF - Work Flap
- GMBH/15 - Glove / Mask Box Holder - One Box, 15mm Hook
- SBH/15 - Sharps Box Holder - One Box, 15mm Hook
- CT/SBB/15 - Sharps Box Bracket - Universal (Daniels / Frontier / Sharpak)
- CT/LH/S - Laptop Holder - Swing Arm
- CT/LH/F - Laptop Holder - Fixed Arm
- CT/LH/C5 - Motion C5 Holder - Swing Arm
- CT/IV - Infusion Pole & Bracket
- Polymer Castors - See page 69



CTS1/14/4S3D



CTS1/14/4S3D - Shown with optional CT/D4/A4



Easy disassembly - see page 38

Caretray Trolleys - Stainless Steel, High Level, Single & Double Column

Features

- High level single & double column easy clean procedure trolleys
- Designed for quick & easy complete disassembly when conducting thorough or deep cleaning programmes (including steam cleaning)
- Seamlessly welded one piece frame from 304 grade stainless steel (requires no on-site assembly)
- One piece moulded top with raised edges on three sides & integral rim at the front to contain any spillages (max load 30kg)
- One piece moulded side panels incorporate runners with positive stops, preventing trays from being accidentally withdrawn
- Carerail fitted to each side of the trolley to support a wide range of accessories (see options)
- 100/150mm deep translucent high impact plastic trays feature an integral handle with plastic clip on label cover, (max load per tray 5kg)
- Each trolley is supplied with perforated coloured label strips (white, blue, green, yellow & red)
- Trays can be subdivided in both length & width using simple slot in dividers (each tray supplied with 2 x long & 2 x short dividers)
- Polyurethane ring buffers offer protection to both the trolley & fabric of the building; smooth surfaces assist cleaning
- 100mm pressed steel castors, 2 off braking

Dimensions (w x d x h)

- Single Column - 550 x 550 x 1410mm
- Double Column - 1005 x 550 x 1410mm
- Plastic Top
 - Single Column - 455 x 455 (internal) at height 1385mm
 - Double Column - 915 x 455 (internal) at height 1385mm
- Trays
 - Shallow Tray - 355 x 405 x 100mm (internal)
 - Deep Tray - 355 x 405 x 150mm (internal)

Item	Description	Weight
CTS1/14/2S5D	2 x 100mm, 5 x 150mm Trays	36.2kg
CTS1/14/3S4D	3 x 100mm, 4 x 150mm Trays	35.8kg
CTS1/14/4S3D	4 x 100mm, 3 x 150mm Trays	35.4kg
CTS1/14/5S3D	5 x 100mm, 3 x 150mm Trays	37.8kg
CTS1/14/6D	6 x 150mm Trays	35.0kg
CTS1/14/8S1D	8 x 100mm, 1 x 150mm Trays	37.8kg

Options

- CT/AGH - Alcohol Gel Holder
- CT/AIR - Airway Tube Holder
- CT/BIN - Debris Bin & Bracket
- CT/DH/A4 - Document Holder, A4
- CT/CR2 & CT/CR5 - Catheter Racks
- CT/CYD - Cylinder Holder - C/CD/D Size
- CT/FS - Flat Shelf - Removable
- Single & Double Doors - See page 60
- CT/WF - Work Flap
- GMBH/15 - Glove / Mask Box Holder - One Box, 15mm Hook
- SBH/15 - Sharps Box Holder - One Box, 15mm Hook
- CT/SBB/15 - Sharps Box Bracket - Universal (Daniels / Frontier / Sharpak)
- CT/IV - Infusion Pole & Bracket
- Polymer Castors - See page 69



CTS2/14/10S6D - Shown with optional CT/DH/A4



CTS2/14/10S6D

Item	Description	Weight
CTS2/14/4S10D	2 x 100mm, 10 x 150mm Trays	60.6kg
CTS2/14/6S8D	6 x 100mm, 8 x 150mm Trays	62.8kg
CTS2/14/8S6D	8 x 100mm, 6 x 150mm Trays	63.0kg
CTS2/14/10S6D	10 x 100mm, 6 x 150mm Trays	65.0kg
CTS2/14/12D	12 x 150mm Trays	61.3kg
CTS2/14/16S2D	16 x 100mm, 2 x 150mm Trays	66.6kg

Caretray Racks - Stainless Steel, Mobile, Single & Double Column

Features

- Single & double column easy clean easy clean rack
- Designed for quick & easy complete disassembly when conducting thorough or deep cleaning programmes (including steam cleaning)
- Seamlessly welded one piece frame from 304 grade stainless steel (requires no on-site assembly)
- One piece moulded top with raised edges on three sides & integral rim at the front to contain any spillages (max load 30kg)
- One piece moulded side panels incorporate runners with positive stops, preventing trays from being accidentally withdrawn
- 100/150mm deep translucent high impact plastic trays feature an integral handle with plastic clip on label cover, (max load per tray 5kg)
- Each trolley is supplied with perforated coloured label strips (white, blue, green, yellow & red)
- Trays can be subdivided in both length & width using simple slot in dividers (each tray supplied with 2 x long & 2 x short dividers)
- Polyurethane ring buffers offer protection to both the trolley & fabric of the building; smooth surfaces assist cleaning
- 100mm pressed steel castors, 2 off braking

Dimensions (w x d x h)

- Single Column - 550 x 550 x 1782mm
- Double Column - 1005 x 550 x 1782mm
- Plastic Top
 - Single Column - 455 x 455 (internal) at height 1757mm
 - Double Column - 915 x 455 (internal) at height 1757mm
- Trays
 - Shallow Tray - 355 x 405 x 100mm (internal)
 - Deep Tray - 355 x 405 x 150mm (internal)

Options

- CT/FS - Flat Shelf - Removable
- Polymer Castors - See page 69

Item	Description	Weight
CRSM1/18/2S6D	2 x 100mm, 6 x 150mm Trays	41.7kg
CRSM1/18/3S6D	3 x 100mm, 6 x 150mm Trays	44.1kg
CRSM1/18/4S5D	4 x 100mm, 5 x 150mm Trays	42.8kg
CRSM1/18/5S5D	5 x 100mm, 5 x 150mm Trays	44.3kg
CRSM1/18/6S4D	6 x 100mm, 4 x 150mm Trays	43.9kg
CRSM1/18/8D	8 x 150mm Trays	43.3kg



CRSM1/18/6S4D



Easy disassembly - see page 38



CRSM2/18/8S10D fitted with C004 (polymer castors)

Item	Description	Weight
CRSM2/18/4S12D	4 x 100mm, 12 x 150mm Trays	72.1kg
CRSM2/18/6S12D	6 x 100mm, 12 x 150mm Trays	77.1kg
CRSM2/18/8S10D	8 x 100mm, 10 x 150mm Trays	75.4kg
CRSM2/18/10S10D	10 x 100mm, 10 x 150mm Trays	78.4kg
CRSM2/18/12S8D	12 x 100mm, 8 x 150mm Trays	77.7kg
CRSM2/18/16D	16 x 150mm Trays	74.6kg

Optional Polymer Castors
 - Easier to manoeuvre -
 - Reduced noise levels -
 - Easy to clean -
 See page 69



CRSM2/18/16D



CRSS1/16/6S4D



Easy disassembly - see page 38

Caretray Racks - Stainless Steel, Static, Single & Double Column

Features

- Single & double column easy clean easy clean rack
- Designed for quick & easy complete disassembly when conducting thorough or deep cleaning programmes (including steam cleaning)
- Seamlessly welded one piece frame from 304 grade stainless steel (requires no on-site assembly)
- One piece moulded top with raised edges on three sides & integral rim at the front to contain any spillages (max load 30kg)
- One piece moulded side panels incorporate runners with positive stops, preventing trays from being accidentally withdrawn
- 100/150mm deep translucent high impact plastic trays feature an integral handle with plastic clip on label cover, (max load per tray 5kg)
- Each trolley is supplied with perforated coloured label strips (white, blue, green, yellow & red)
- Trays can be subdivided in both length & width using simple slot in dividers (each tray supplied with 2 x long & 2 x short dividers)
- Adjustable feet allow levelling on uneven floors

Dimensions (w x d x h)

- Single Column - 536 x 536 x 1670-1685mm
- Double Column - 995 x 536 x 1670-1685mm
- Plastic Top
 - Single Column - 455 x 455 (internal) at height 1645mm
 - Double Column - 915 x 455 (internal) at height 1645mm
- Trays
 - Shallow Tray - 355 x 405 x 100mm (internal)
 - Deep Tray - 355 x 405 x 150mm (internal)

Options

- CT/FS - Flat Shelf - Removable

Item	Description	Weight
CRSS1/16/2S6D	2 x 100mm, 6 x 150mm Trays	38.4kg
CRSS1/16/3S6D	3 x 100mm, 6 x 150mm Trays	40.8kg
CRSS1/16/4S5D	4 x 100mm, 5 x 150mm Trays	39.5kg
CRSS1/16/5S5D	5 x 100mm, 5 x 150mm Trays	41.0kg
CRSS1/16/6S4D	6 x 100mm, 4 x 150mm Trays	40.6kg
CRSS1/16/8D	8 x 150mm Trays	40.0kg



CRSS2/16/8S10D

Item	Description	Weight
CRSS2/16/4S12D	4 x 100mm, 12 x 150mm Trays	71.1kg
CRSS2/16/6S12D	6 x 100mm, 12 x 150mm Trays	74.0kg
CRSS2/16/8S10D	8 x 100mm, 10 x 150mm Trays	72.3kg
CRSS2/16/10S10D	10 x 100mm, 10 x 150mm Trays	75.3kg
CRSS2/16/12S8D	12 x 100mm, 8 x 150mm Trays	74.6kg
CRSS2/16/16D	16 x 150mm Trays	71.5kg



CRSS2/16/16D

Caretray Trolleys - Mild Steel, Low Level, Single & Double Column

Features

- Low level single & double column easy clean procedure trolleys. Height makes it suitable to be stored underbench
- Designed for quick & easy complete disassembly when conducting thorough or deep cleaning programmes (including steam cleaning)
- Fully welded mild steel frame that is blast finished & powder coated in a durable epoxy paint (requires no on-site assembly)
- One piece moulded top with raised edges on three sides & integral rim at the front to contain any spillages (max load 30kg)
- One piece moulded side panels incorporate runners with positive stops, preventing trays from being accidentally withdrawn
- Carerail fitted to each side of the trolley to support a wide range of accessories (see options)
- 100/150mm deep translucent high impact plastic trays feature an integral handle with plastic clip on label cover, (max load per tray 5kg)
- Each trolley is supplied with perforated coloured label strips (white, blue, green, yellow & red)
- Trays can be subdivided in both length & width using simple slot in dividers (each tray supplied with 2 x long & 2 x short dividers)
- Polyurethane ring buffers offer protection to both the trolley & fabric of the building; smooth surfaces assist cleaning
- 100mm pressed steel castors, 2 off braking

Dimensions (w x d x h)

- Single Column - 550 x 550 x 807mm
- Double Column - 1005 x 550 x 807mm
- Plastic Top
 - Single Column - 455 x 455 (internal) at height 782mm
 - Double Column - 915 x 455 (internal) at height 782mm
- Trays
 - Shallow Tray - 355 x 405 x 100mm (internal)
 - Deep Tray - 355 x 405 x 150mm (internal)

Standard Colours

- Paint - Spearmint

Item	Description	Weight
CTM1/08/1S2D	1 x 100mm, 2 x 150mm Trays	20.9kg
CTM1/08/3D	3 x 150mm Trays	21.2kg
CTM1/08/3S1D	3 x 100mm, 1 x 150mm Trays	22.0kg
CTM1/08/4S	4 x 100mm Trays	21.6kg



CTM1/08/3S1D



CTM1/08/3S1D - Shown with optional CT/WF, SBH/15 & CT/AGH



Easy disassembly - see page 38



CTM2/08/4S3D



CTM2/08/4S3D - Shown with optional CT/WF, SBH/15, CT/AGH

Optional Polymer Castors
 - Easier to manoeuvre -
 - Reduced noise levels -
 - Easy to clean -
 See page 69



Page 410

Options

- CT/AGH - Alcohol Gel Holder
- CT/AIR - Airway Tube Holder
- CT/BIN - Debris Bin & Bracket
- CT/DH/A4 - Document Holder, A4
- CT/CR2 & CT/CR5 - Catheter Racks
- CT/CYD - Cylinder Holder - C/CD/D Size
- Single & Double Doors - See page 60
- CT/FS - Removable Flat Shelf
- CT/IV - Infusion Pole & Bracket
- CT/WF - Work Flap
- GMBH/15 - Glove / Mask Box Holder - One Box, 15mm Hook
- SBH/15 - Sharps Box Holder - One Box, 15mm Hook
- CT/SBB/15 - Sharps Box Bracket - Universal (Daniels / Frontier / Sharpak)
- Polymer Castors - See page 69

Item	Description	Weight
CTM2/08/3S4D	3 x 100mm, 4 x 150mm Trays	36.8kg
CTM2/08/4S3D	4 x 100mm, 3 x 150mm Trays	36.4kg
CTM2/08/6D	6 x 150mm Trays	36.0kg
CTM2/08/6S2D	6 x 100mm, 2 x 150mm Trays	37.6kg
CTM2/08/7S1D	7 x 100mm, 1 x 150mm Trays	37.2kg
CTM2/08/8S	8 x 100mm Trays	36.8kg

Caretray Trolleys - Mild Steel, Standard Level, Single & Double Column



CTM1/10/3S2D



Easy disassembly - see page 38

Features

- Standard level single & double column easy clean procedure trolleys
- Designed for quick & easy complete disassembly when conducting thorough or deep cleaning programmes (including steam cleaning)
- Fully welded mild steel frame that is blast finished & powder coated in a durable epoxy paint (requires no on-site assembly)
- One piece moulded top with raised edges on three sides and integral rim at the front to contain any spillages (max load 30kg)
- One piece moulded side panels incorporate runners with positive stops, preventing trays from being accidentally withdrawn
- Carerails fitted to each side of the trolley to support a wide range of accessories (see options)
- 100/150mm deep translucent high impact plastic trays feature an integral handle with plastic clip on label cover, (max load per tray 5kg)
- Each trolley is supplied with perforated coloured label strips (white, blue, green, yellow & red)
- Trays can be subdivided in both length & width using simple slot in dividers (each tray supplied with 2 x long & 2 x short dividers)
- Polyurethane ring buffers offer protection to both the trolley & fabric of the building; smooth surfaces assist cleaning
- 100mm pressed steel castors, 2 off braking

Dimensions (w x d x h)

- Single Column - 550 x 550 x 993mm
- Double Column - 1005 x 550 x 993mm
- Plastic Top
 - Single Column - 455 x 455 (internal) at height 968mm
 - Double Column - 915 x 455 (internal) at height 968mm
- Trays
 - Shallow Tray - 355 x 405 x 100mm (internal)
 - Deep Tray - 355 x 405 x 150mm (internal)

Standard Colours

- Paint - Spearmint

Item	Description	Weight
CTM1/10/1S3D	1 x 100mm, 3 x 150mm Trays	27.5kg
CTM1/10/3S2D	3 x 100mm, 2 x 150mm Trays	28.6kg
CTM1/10/4D	4 x 150mm Trays	27.9kg
CTM1/10/4S1D	4 x 100mm, 1 x 150mm Trays	28.3kg
CTM1/10/6S	6 x 100mm	29.4kg



CTM2/10/6S4D



CTM2/10/6S4D - Shown with optional CT/IV, CT/CR2, GMBH/15 & CT/AGH

Item	Description	Weight
CTM2/10/3S6D	3 x 100mm, 6 x 150mm Trays	46.0kg
CTM2/10/4S5D	4 x 100mm, 5 x 150mm Trays	45.6kg
CTM2/10/5S4D	5 x 100mm, 4 x 150mm Trays	45.3kg
CTM2/10/6S4D	6 x 100mm, 4 x 150mm Trays	46.7kg
CTM2/10/8D	8 x 150mm Trays	45.2kg
CTM2/10/8S2D	8 x 100mm, 2 x 150mm Trays	46.0kg

Options

- CT/AGH - Alcohol Gel Holder
- CT/AIR - Airway Tube Holder
- CT/BIN - Debris Bin & Bracket
- CT/DH/A4 - Document Holder, A4
- CT/CR/2 & CT/CR/5 - Catheter Racks
- CT/CYD - Cylinder Holder - C/CD/D Size
- Single & Double Doors - See page 60
- CT/FS - Flat Shelf, Removable
- CT/IV - Infusion Pole & Bracket
- CT/WF - Work Flap
- GMBH/15 - Glove / Mask Box Holder - One Box, 15mm Hook
- SBH/15 - Sharps Box Holder - One Box, 15mm Hook
- CT/SBB/15 - Sharps Box Bracket - Universal (Daniels / Frontier / Sharpak)
- Laptop Holders - See page 64
- CT/LH/C5 - Motion C5 Holder, Swing Arm
- CT/OB/MS - Overbridge
- Tilt Bins - See page 70
- Polymer Castors - See page 69



CTM1/14/4S3D



Easy disassembly
see page 38



Options

- CT/AGH - Alcohol Gel Holder
- CT/AIR - Airway Tube Holder
- CT/BIN - Debris Bin & Bracket
- CT/DH/A4 - Document Holder, A4
- CT/CR2 & CT/CR5 - Catheter Racks
- CT/CYD - Cylinder Holder - C/CD/D Size
- Single & Double Doors - See page 60
- CT/FS - Flat Shelf - Removable
- CT/WF - Work Flap
- GMBH/15 - Glove / Mask Box Holder - One Box, 15mm Hook
- SBH/15 - Sharps Box Holder - One Box, 15mm Hook
- CT/SBB/15 - Sharps Box Bracket - Universal (Daniels / Frontier / Sharpak)
- Polymer Castors - See page 69

Caretray Trolleys - Mild Steel, High Level, Single & Double Column

Features

- High level single & double column easy clean procedure trolleys
- Designed for quick & easy complete disassembly when conducting thorough or deep cleaning programmes (including steam cleaning)
- Fully welded mild steel frame that is blast finished & powder coated in a durable epoxy paint (requires no on-site assembly)
- One piece moulded top with raised edges on three sides & integral rim at the front to contain any spillages (max load 30kg)
- One piece moulded side panels incorporate runners with positive stops, preventing trays from being accidentally withdrawn
- Carerail' fitted to each side of the trolley to support a wide range of accessories (see options)
- 100/150mm deep translucent high impact plastic trays feature an integral handle with plastic clip on label cover, (max load per tray 5kg)
- Each trolley is supplied with perforated coloured label strips (white, blue, green, yellow & red)
- Trays can be subdivided in both length & width using simple slot in dividers (each tray supplied with 2 x long & 2 x short dividers)
- Polyurethane ring buffers offer protection to both the trolley & fabric of the building; smooth surfaces assist cleaning
- 100mm pressed steel castors, 2 off braking

Dimensions (w x d x h)

- Single Column - 550 x 550 x 1410mm
- Double Column - 1005 x 550 x 1410mm
- Plastic Top
 - Single Column - 455 x 455 (internal) at height 1385mm
 - Double Column - 915 x 455 (internal) at height 1385mm
- Trays
 - Shallow Tray - 355 x 405 x 100mm (internal)
 - Deep Tray - 355 x 405 x 150mm (internal)

Standard Colours

- Paint - Spearmint

Item	Description	Weight
CTM1/14/2S5D	2 x 100mm, 5 x 150mm Trays	36.2kg
CTM1/14/3S4D	3 x 100mm, 4 x 150mm Trays	35.8kg
CTM1/14/4S3D	4 x 100mm, 3 x 150mm Trays	35.4kg
CTM1/14/5S3D	5 x 100mm, 3 x 150mm Trays	37.3kg
CTM1/14/6D	6 x 150mm Trays	35.0kg
CTM1/14/8S1D	8 x 100mm, 1 x 150mm Trays	37.2kg



CTM2/14/10S6D - Shown with optional CTD2/14SS
(Double door fitted with Security Seal Lock)

Item	Description	Weight
CTM2/14/4S10D	2 x 100mm, 10 x 150mm Trays	60.6kg
CTM2/14/6S8D	6 x 100mm, 8 x 150mm Trays	62.8kg
CTM2/14/8S6D	8 x 100mm, 6 x 150mm Trays	62.3kg
CTM2/14/10S6D	10 x 100mm, 6 x 150mm Trays	65.0kg
CTM2/14/12D	12 x 150mm Trays	61.3kg
CTM2/14/16S2D	16 x 100mm, 2 x 150mm Trays	66.6kg



CTM2/14/10S6D

Caretray Racks - Mild Steel, Mobile, Single & Double Column

Features

- Single & double column easy clean easy clean rack
- Designed for quick & easy complete disassembly when conducting thorough or deep cleaning programmes (including steam cleaning)
- Fully welded mild steel frame that is blast finished & powder coated in a durable epoxy paint (requires no on-site assembly)
- One piece moulded top with raised edges on three sides & integral rim at the front to contain any spillages (max load 30kg)
- One piece moulded side panels incorporate runners with positive stops, preventing trays from being accidentally withdrawn
- 100/150mm deep translucent high impact plastic trays feature an integral handle with plastic clip on label cover, (max load per tray 5kg)
- Each trolley is supplied with perforated coloured label strips (white, blue, green, yellow & red)
- Trays can be subdivided in both length & width using simple slot in dividers (each tray supplied with 2 x long & 2 x short dividers)
- Polyurethane ring buffers offer protection to both the trolley & fabric of the building; smooth surfaces assist cleaning
- 100mm pressed steel castors, 2 off braking

Dimensions (w x d x h)

- Single Column - 550 x 550 x 1782mm
- Double Column - 1005 x 550 x 1782mm
- Plastic Top
 - Single Column - 455 x 455 (internal) at height 1757mm
 - Double Column - 915 x 455 (internal) at height 1757mm
- Trays
 - Shallow Tray - 355 x 405 x 100mm (internal)
 - Deep Tray - 355 x 405 x 150mm (internal)

Standard Colours

- Paint - Spearmint

Options

- CT/FS - Removable Flat shelf
- Polymer Castors - See page 69



Easy disassembly
see page 38

Optional Polymer Castors

- Easier to manoeuvre -
 - Reduced noise levels -
 - Easy to clean -
- See page 69

Item	Description	Weight
CRMM1/18/2S6D	2 x 100mm, 6 x 150mm Trays	41.2kg
CRMM1/18/3S6D	3 x 100mm, 6 x 150mm Trays	43.6kg
CRMM1/18/4S5D	4 x 100mm, 5 x 150mm Trays	42.3kg
CRMM1/18/5S5D	5 x 100mm, 5 x 150mm Trays	43.8kg
CRMM1/18/6S4D	6 x 100mm, 4 x 150mm Trays	43.4kg
CRMM1/18/8D	8 x 150mm Trays	42.8kg



CRMM2/18/8S10D

Item	Description	Weight
CRMM2/18/4S12D	4 x 100mm, 12 x 150mm Trays	73.3kg
CRMM2/18/6S12D	6 x 100mm, 12 x 150mm Trays	76.3kg
CRMM2/18/8S10D	8 x 100mm, 10 x 150mm Trays	74.6kg
CRMM2/18/10S10D	10 x 100mm, 10 x 150mm Trays	77.6kg
CRMM2/18/12S8D	12 x 100mm, 8 x 150mm Trays	76.9kg
CRMM2/18/16D	16 x 150mm Trays	73.8kg



Alternative Colours
Page 410



CRMM2/18/16D

Caretray Racks - Mild Steel, Static, Single & Double Column



CRMS1/16/6S4D



Easy disassembly - see page 38

Features

- Single & double column easy clean easy clean rack
- Designed for quick & easy complete disassembly when conducting thorough or deep cleaning programmes (including steam cleaning)
- Fully welded mild steel frame that is blast finished & powder coated in a durable epoxy paint (requires no on-site assembly)
- One piece moulded top with raised edges on three sides & integral rim at the front to contain any spillages (max load 30kg)
- One piece moulded side panels incorporate runners with positive stops, preventing trays from being accidentally withdrawn
- 100/150mm deep translucent high impact plastic trays feature an integral handle with plastic clip on label cover, (max load per tray 5kg)
- Each trolley is supplied with perforated coloured label strips (white, blue, green, yellow & red)
- Trays can be subdivided in both length & width using simple slot in dividers (each tray supplied with 2 x long & 2 x short dividers)
- Adjustable feet allow levelling on uneven floors

Dimensions

- Single Column - 536 x 536 x 1670-1685mm
- Double Column - 995 x 536 x 1670-1685mm
- Plastic Top
 - Single Column - 455 x 455 (internal) at height 1645mm
 - Double Column - 915 x 455 (internal) at height 1645mm
- Trays
 - Shallow Tray - 355 x 405 x 100mm (internal)
 - Deep Tray - 355 x 405 x 150mm (internal)

Standard Colours

- Paint - Spearmint

Options

- CT/FS - Removable Flat Self

Item	Description	Weight
CRMS1/16/2S6D	2 x 100mm, 6 x 150mm Trays	38.4kg
CRMS1/16/3S6D	3 x 100mm, 6 x 150mm Trays	39.5kg
CRMS1/16/4S5D	4 x 100mm, 5 x 150mm Trays	39.5kg
CRMS1/16/5S5D	5 x 100mm, 5 x 150mm Trays	41.0kg
CRMS1/16/6S4D	6 x 100mm, 4 x 150mm Trays	40.6kg
CRMS1/16/8D	8 x 150mm Trays	39.6kg



CRMS2/16/16D

Item	Description	Weight
CRMS2/16/4S12D	4 x 100mm, 12 x 150mm Trays	70.2kg
CRMS2/16/6S12D	6 x 100mm, 12 x 150mm Trays	73.2kg
CRMS2/16/8S10D	8 x 100mm, 10 x 150mm Trays	72.3kg
CRMS2/16/10S10D	10 x 100mm, 10 x 150mm Trays	75.3kg
CRMS2/16/12S8D	12 x 100mm, 8 x 150mm Trays	74.6kg
CRMS2/16/16D	16 x 150mm Trays	71.5kg



CRMS2/16/8S10D



CTM2/14/6S8D/CTD2/14SS
(Double door fitted with Security Seal Lock)

CTM2/10/6S4D/CTD2/10EPB
(Double door fitted with Electronic Push Button Lock)

Doors & Back Panels

Features

- Machined solid grade laminate doors allowing for easy cleaning
- Doors fold back against the sides of the trolley when open
- Double door units feature a return to ensure that only one lock is required to secure both doors
- Three locking options
 - CAM Lock with Wing Handle
 - Supplied with two keys
 - Wing handle can operate independently of the key
 - Locks keyed to differ
 - Keyed alike on request
 - † Security Seal
 - Accepts standard plastic security seals
 - Security seals not included with door
 - † Electronic Push Button
- Units fitted with a door also supplied with a removable back panel to ensure contents of the trolley are secure
- Factory fitted

Locking Options



CAM with Wing Handle



Security Seal



Electronic Push Button

Description	CAM Lock with Wing Handle	Security Seal	Electronic Push Button	Trolley Compatibility
Single Door & Back Panel	CTD1/08CA	CTD1/08SS	CTD1/08EPB	CTM1/08, CTS1/08
Double Door & Back Panel	CTD2/08CA	CTD2/08SS	CTD2/08EPB	CTM2/08, CTS2/08
Single Door & Back Panel	CTD1/10CA	CTD1/10SS	CTD1/10EPB	CTM1/10, CTS1/10
Double Door & Back Panel	CTD2/10CA	CTD2/10SS	CTD2/10EPB	CTM2/10, CTS2/10
Single Door & Back Panel	CTD1/14CA	CTD1/14SS	CTD1/14EPB	CTM1/14, CTS1/14
Double Door & Back Panel	CTD2/14CA	CTD2/14SS	CTD2/14EPB	CTM2/14, CTS2/14



CTM1/08/3S1D/CTD1/08CA
(Single door fitted with CAM Lock with Wing Handle)

Electronic Push Button Lock

- Uses a 10 button keypad and a # button. The # button is hidden beneath the handle when in the locked position
- Easy programming & code change
- Four operating codes with differing levels of authority
 - Master code
 - Sub-master code
 - User code
 - Technician code
- User codes are 4 digits
- Master & sub-master codes are 8 digits
- 15,000 openings on 2 x AAA cells (supplied)
- Low battery warning with failure override using 9v battery across LED's (+/-) & master code



CTM1/10/3S2D/CTD1/10EPB
(Single door fitted with Electronic Push Button Lock)

CTM1/14/4S3D/CTD1/14SS
(Single door fitted with Security Seal Lock)



Laptop Holder - Removable, Swing Arm

Features

- Three section swing arm offering height, rotation & angle adjustment
- Compatible with models CTM1/10, CTM2/10, CTS1/10, CTS2/10
- Laptop holder fitted to the rear right upright of the trolley
- Adjustable to accept laptops 280-435 x 22mm (w x h)
- Maximum capacity 2.0kg
- Laptop supported in a cradle fitted with adjustable wing arms
- Laptop can be secured using a security clamp (supplied)*
- Design allows easy access to laptop ports

*Not compatible with the Dell laptops using the N17 wedge lock system

Standard Colours

- Paint - Grey White

Item	Description	Weight
CT/LHR/S	Removable, Swing Arm	4.4kg

Laptop Holder - Non-Removable, Swing Arm

Features

- Three section swing arm offering height, rotation & angle adjustment
- Compatible with models CTM1/10, CTM2/10, CTS1/10, CTS2/10
- Laptop holder fitted to the rear right upright of the trolley
- Adjustable to accept laptops 280-435 x 22mm (w x h)
- Maximum capacity 2.0kg
- Laptop supported in a cradle fitted with a steel mounting bracket that can be fixed using either nylock or wing nuts
- Laptop can be secured using a security clamp (supplied)*
- Design allows easy access to laptop ports

*Not compatible with the Dell laptops using the N17 wedge lock system

Standard Colours

- Paint - Grey White

Item	Description	Weight
CT/LHNR/S	Non-Removable, Swing Arm	5.7kg

Laptop supported in a cradle fitted with a steel mounting bracket that can be fixed using either nylock or wing nuts



CTM1/10/3S2D/CT/LHR/S

Motion C5 Holder - Swing Arm

Features

- Three section swing arm offering height, rotation & angle adjustment
- Compatible with models CTM1/10, CTM2/10, CTS1/10, CTS2/10
- Motion C5 holder fitted to the rear right upright of the trolley
- Maximum capacity 2.0kg
- Tablet located in a RAM-In-Motion passive dock allowing for easy insertion & removal

Standard Colours

- Paint - Grey White



Item	Description	Weight
CT/LH/C5	Swing Arm	3.4kg

Work Flap

Features

- Fold down flap (provides work area 300 x 455mm)
- Machined from solid grade laminate allowing for easy cleaning
- Attaches to upper carerail
- Maximum capacity 2kg

Standard Colours

- Paint - Grey White
- Solid Grade Laminate - Grey White

Dimensions (w x d x h)

- 325 x 465 x 70mm



Item	Description	Weight
CT/WF	Work Flap	3.2kg

Infusion Pole & Bracket

Features

- Two hook infusion pole & bracket (pole length 1160mm)
- Attaches to upper carerail
- Maximum capacity on hooks 2kg

Standard Colours

- Paint - Grey White

Dimensions (w x d x h)

- 238 x 104 x 1157mm



Item	Description	Weight
CT/IV	Infusion Pole & Bracket	1.6kg

Cylinder Holder - C/CD/D Size

Features

- Compatible with C/CD/D size cylinders (max diameter 100mm)
- Cylinder held in position using a chain, whilst rubber pads protect wear points & reduce noise
- Attaches to upper carerail

Standard Colours

- Paint - Grey White

Dimensions (w x d x h)

- 145 x 135 x 400mm



Oxygen cylinder not supplied

Item	Description	Weight
CT/CYD	Cylinder Holder - C/CD/D Size	1.4kg

Airway Tube Holder

Features

- Internal dimensions of holder 95 x 50 x 510mm
- Outer sleeve removable for cleaning
- Fitted with a 15mm square hook
- Attaches to upper carerail

Standard Colours Dimensions (w x d x h)

- Paint - Grey White
- 140 x 70 x 555mm



Item	Description	Weight
CT/AIR	Airway Tube Holder	1.4kg

Alcohol Gel Holder

Features

- Accepts bottles with maximum 90 x 90mm square base
- Fitted with a 15mm hook
- Attaches to upper/lower carerails

Standard Colours

- Stainless Steel

Dimensions (w x d x h)

- 95 x 110 x 115mm



Alcohol gel not supplied

Item	Description	Weight
CT/AGH	Alcohol Gel Holder	0.3kg

Glove / Mask Box Holder One Box, 15mm Hook

Features

- Accommodates glove & mask boxes up to 150mm in width
- One piece construction
- 15mm hook attaches to upper/lower carerails

Standard Colours

- Paint - Grey White

Dimensions (w x d x h)

- 143 x 122 x 177mm



Glove box not supplied

Item	Description	Weight
GMBH/15	Glove / Mask Box Holder - One Box, 15mm Hook	0.6kg

Sharps Box Holder One Box, 15mm Hook

Features

- Accepts sharps boxes up to seven litres capacity
- Sharps box secured using a rubber band fitted with a toggle
- 15mm hook attaches to upper/lower carerails

Standard Colours

- Paint - Grey White

Dimensions (w x d x h)

- 127 x 118 x 230mm



Item	Description	Weight
SBH/15	Sharps Box Holder	0.5kg

Sharps Box Bracket - Universal

Features

- Compatible with the following brackets (customer to supply the plastic brackets & fit - fixings supplied).
- Daniels Healthcare
- POUNDS® Wall-Bracket (up to 5L) - SHARPSGUARD® mini, 1, 2.5, 3.75, 5 & com plus
- POUNDS® Wall-Bracket (7L & above) - SHARPSGUARD® 7, 11.5 & 22
- Frontier (Sharpsafe) - 2, 3, 4 & 7
- Sharpak Healthcare - Sharpak 18, 35, 60, 120 & 220 PLUS
- 15mm hook attaches to upper/lower carerails

Standard Colours

- Paint - Grey White

Dimensions (w x d x h)

- 75 x 32 x 152mm



Plastic brackets not supplied

Item	Description	Weight
CT/SBB/15	Sharps Box Bracket - Universal	0.2kg

Debris Bin & Bracket

Features

- Plastic debris bin & bracket
- 15mm hook attaches to upper/lower carerails

Standard Colours

- Paint - Grey White

Dimensions (w x d x h)

- Overall Dimensions - 210 x 164 x 109mm
- Internal Dimensions - 195 x 130 x 95mm



Item	Description	Weight
CT/BIN	Debris Bin & Bracket	0.4kg

Catheter Racks

Features

- Internal dimensions of each section 64 x 75 x 400mm
- Removable clear perspex panel to aid cleaning
- 15mm hook attaches to upper/lower carerails

Standard Colours

- Paint - Grey White

Dimensions (w x d x h)

- CT/CR2 - 130 x 108 x 405mm
- CT/CR5 - 325 x 108 x 405mm



Item	Description	Weight
CT/CR2	Two Section	1.4kg
CT/CR5	Five Section	3.0kg

Document Holder

Features

- A4 size suitable for A4 ring binders or foolscap notes (pocket size 274 x 63mm)
- Open front design allows for easy patient identification
- 15mm hook attaches to upper/lower carerails

Standard Colours

- Paint - Grey White

Dimensions (w x d x h)

- 275 x 82 x 402mm



Item	Description	Weight
CT/DH/A4	Document Holder	1.7kg

Flat Shelf - Removable

Features

- Solid grade laminate (max load per shelf 5kg)
- Supported on the runner guides (non pull out)

Standard Colours

- Solid Grade Laminate - Grey White

Dimensions (w x d x h)

- 413 x 457 x 4mm



Item	Description	Weight
CT/FS	Flat Shelf - Removable	1.1kg

Tilt Bins

Features

- Available with 4, 5 or 6 tilting compartments
- Clear tilt bins provide visible storage & assists organisation
- Compartments tilt forward to a 45° angle allowing easy access of contents & can be removed to aid refilling/cleaning
- Label holder for easy identification of the contents
- Retaining bar secures compartments in place, preventing bins from tipping forward during transit
- Supplied with a mild/stainless steel mounting plate
- Attaches to an overbridge (order separately)

Dimensions (w x d x h)

Compartment Dimensions

- TBIN4 - 143 x 127 x 190mm
- TBIN5 - 108 x 95 x 146mm
- TBIN6 - 89 x 67 x 95mm

Standard Colours

- Plastic - Cream
- Paint - Grey White
- Stainless Steel - Self Colour



45° Angle Tilt

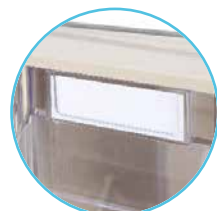

Label Holder



Top: TBIN6/MS
Middle: TBIN5/MS
Bottom: TBIN4/MS

Overbridge

Features

- Fixes onto the rear uprights of the trolley (increases overall height by 625mm)
- Available as either painted mild steel or self-colour stainless steel
- Provides a fixing location for tilt bins (order separately)
- Factory fitted

Standard Colours

- Paint - Grey White
- Stainless Steel - Self Colour



Item	Description	Weight
CT/OB/MS	Overbridge, Mild Steel	2.0kg
CT/OB/SS	Overbridge, Stainless Steel	2.0kg

Additional Trays

Features

- 100/150mm deep translucent high impact plastic trays with integral handle (max load per tray 5kg)
- Each tray is supplied with plastic clip on label cover & four removable dividers (2 x long & 2 x short)
- Trays are supplied without coloured label strips (see CT/LAB)

Internal Dimensions (w x d x h)

- CT/TRAY/S - 355 x 405 x 100mm
- CT/TRAY/D - 355 x 405 x 150mm



Item	Description	Weight
CT/TRAY/S	100mm Shallow Tray	1.5kg
CT/TRAY/D	150mm Deep Tray	1.8kg

Additional Dividers

Features

- 100/150mm deep translucent dividers
- Supplied as a set of 2 x long & 2 x short



Item	Description	Weight
CT/DIV/S	Set of 4 dividers for 100mm Shallow Tray	0.6kg
CT/DIV/D	Set of 4 dividers for 150mm Deep Tray	0.4kg

Additional Label Strips

Features

- Coloured label strips
 - Red
 - Yellow
 - Green
 - Blue
 - White
- Supplied as a set of 6 sheets



Item	Description
CT/LAB	Coloured Label Strips

Polymer Castors

Features

- Offers reduced rolling resistance making the trolley easier to manoeuvre, lower noise levels & smooth surfaces to assist cleaning
- Supplied as a set of 4 castors
 - 2 x braking / 2 x non-braking
 - 4 x braking
 - 4 x non-braking
- Factory fitted



Item	Description	Weight
C004	100mm, Grey White Polymer, 2 x Braking / 2 x Non-Braking (set of 4)	2.0kg
C005	100mm, Grey White Polymer, 4 x Braking (set of 4)	2.0kg
C006	100mm, Grey White Polymer, 4 x Non-Braking (set of 4)	2.0kg

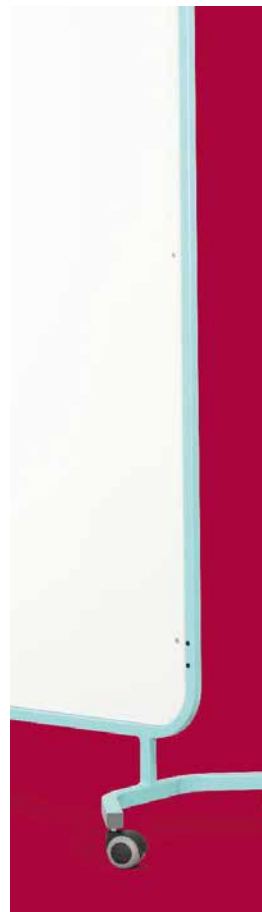

Chart Trolleys Workstations Room Dividers & Screens

Fixed Height Trolleys	72
Fixed Height Workstations	74
Variable Height Workstations	75
Chart Boards	76
Document Holders	77
Room Dividers	78
Curtain Screens	80
Solid Screens	81



CTCHARM1/10/3S2D

Caretray Trolley - Chart

Features

- Single & double column fixed height chart trolleys
- Angle adjustable chartboard fitted with a spring clip (adjustable 7-45 degrees)
- Usable chart area...
 - Single Column - 500 x 530mm (w x h)
 - Double Column - 800 x 530mm (w x h)
- Lower lip on chartboard to support pens etc.
- Designed for quick & easy disassembly when conducting thorough or deep cleaning programmes (including steam cleaning)
- Fully welded mild steel frame that is blast finished & powder coated in a durable epoxy paint (requires no on-site assembly)
- One piece moulded side panels incorporate runners with positive stops, preventing trays from being accidentally withdrawn
- Carerails fitted to each side of the trolley (2 x L/H, 1 x R/H) to support a wide range of accessories (see options)
- Drop down work flap fitted to R/H side
- 100/150mm deep translucent high impact plastic trays feature an integral handle with plastic clip on label cover (max load per tray 5kg)
- Each trolley is supplied with perforated coloured label strips - white, blue, green, yellow & red (not shown on trolley)
- Trays can be subdivided in both length & width using simple slot in dividers (each tray supplied with 2 x long & 2 x short dividers)
- 100mm pressed steel castors, 2 off braking

Dimensions (w x d x h)

- Overall Dimensions
 - Single Column - 550 x 665 x 1115-1450mm
 - Double Column - 1005 - 665 x 1115-1450mm
- Usable Chart Area
 - Single Column - 500 x 530mm
 - Double Column - 800 x 530mm
- Work Flap - 420 x 290mm (w x d)
- Trays
 - Shallow Tray - 355 x 405 x 100mm (internal)
 - Deep Tray - 355 x 405 x 150mm (internal)

Standard Colours

- Paint - White
- Chartboard/Work Flap - White

Item	Description	Weight
CTCHARM1/10/3S2D	Caretray Trolley - Chart, 3 x 100mm, 2 x 150mm Trays	33.2kg
CTCHARM1/10/4S1D	Caretray Trolley - Chart, 4 x 100mm, 1 x 150mm Trays	32.9kg

Optional Polymer Castors

- Easier to manoeuvre
- Reduced noise levels
- Easy to clean
- See page 69



Angle adjustable chartboard fitted with spring clip/s (adjustable 7-45 degrees)

Options

- CT/DH/A4 - Document Holder, A4
- CT/AGH - Alcohol Gel Holder
- CT/FS - Flat Shelf - Removable
- DAR/1/15 - Apron Roll Holder
- DG/3/15 - Three Glove Box Holder
- GMBH/15 - Glove / Mask Box Holder - One Box, 15mm Hook
- CT/SBB/15 - Sharps Box Bracket - Universal (Daniels / Frontier / Sharpak)
- SBH/15 - Sharps Box Holder - One Box, 15mm Hook
- ZP010 - 100mm Ring Buffers
- C004, C005, C006 Polymer Castors - See page 69



CTCHARM2/10/6S4D

Item	Description	Weight
CTCHARM2/10/6S4D	Caretray Trolley - Chart, 6 x 100mm, 4 x 150mm Trays	53.2kg
CTCHARM2/10/8S2D	Caretray Trolley - Chart, 8 x 100mm, 2 x 150mm Trays	51.2kg



Chart Workstations - Fixed Height

Features

- Angle adjustable chartboard fitted with a spring clip (adjustable 0-60 degrees)
- Usable chart area 800 x 530 (w x h)
- Lower lip on chartboard to support pens etc
- Models available with:
 - Chartboard only
 - Drawer
- Rails fitted to each side to support a wide range of accessories (see options)
- 100mm pressed steel castors, 2 off braking

Dimensions (w x d x h)

- Overall Dimensions - 820 x 680 x 1040 - 1510mm
- Usable Chart Area - 800 x 530mm (w x h)
- Drawer - 650 x 397 x 100mm (internal)

Standard Colours

- Paint - White
- Chartboard/Work Flap - White

Options

- CBT900 - Work Flap
- CBT905 - Lower Tray
- CT/DH/A4 - Document Holder, A4
- CT/AGH - Alcohol Gel Holder
- DG/3/15 - Three Glove Box Holder
- GMBH/15 - Glove / Mask Box Holder - One Box, 15mm Hook
- CT/SBB/15 - Sharps Box Bracket - Universal (Daniels / Frontier / Sharpak)
- SBH/15 - Sharps Box Holder - One Box, 15mm Hook
- ZP010 - 100mm Ring Buffers

Item	Description	Weight
CBT050	Chart Workstation - Fixed Height	25.3kg
CBT055	Chart Workstation - Fixed Height, Drawer	35.0kg

Chart Workstations - Variable Height

Features

- Height adjustable using a gas damper (795-1075mm)
- Angle adjustable chartboard fitted with spring clips (adjustable 0-90 degrees)
- Chartboard available in three sizes (w x h)
 - Small - 790 x 700mm
 - Medium - 790 x 800mm
 - Large - 790 x 900mm
- Lower lip on chartboard to support pens etc
- Slide out shelf at front
- Document storage pocket on side to accept patients notes, ring binders, etc
- 80mm swivel castors, 2 off braking

Dimensions (w x d x h)

- Overall Dimensions - 800 x 700/800/900 x 1095mm
- Document Storage Compartment - 75 x 255 x 360mm (internal)

Standard Colours

- Paint - White
- Chartboard - White

Options

- ZP010 - 100mm Ring Buffers

Item	Description	Weight
CB/100/A	700mm High Board	40.0kg
CB/100/B	800mm High Board	41.0kg
CB/100/C	900mm High Board	42.5kg



Chart Boards - A4 & A3

Features

- A4 one spring clip (holds one chart 220 x 280mm)
- A3 two spring clips (holds one chart 450 x 280mm or two charts 220 x 280mm)
- Available with a 30 or 50mm mild steel square hook

Standard Colours

- White



CB005



CB015

Item	Description	Overall Dimensions (w x d x h)	Weight
A4 Chart Board			
CB005	A4, 30mm Square Mild Steel Hook	230 x 80 x 370mm	0.5kg
CB010	A4, 50mm Square Mild Steel Hook	230 x 100 x 370mm	0.5kg
A3 Chart Board			
CB015	A3, 30mm Square Mild Steel Hook	460 x 80 x 370mm	0.8kg
CB020	A3, 50mm Square Mild Steel Hook	460 x 100 x 370mm	0.8kg

Document Holders - A4 & A3

Features

- A4 size suitable for A4 ring binders or foolscap notes (pocket size 260 x 65mm)
- A3 size suitable for A3 notes and x-rays (pocket size 398 x 100mm)
- Open front design allows for easy patient identification
- Available for wall fitting or with a 50mm square hook

Standard Colours

- Paint - Grey White



DH/A3/50



DH/A4/WF

Item	Description	Overall Dimensions (w x d x h)	Weight
A4 Document Holder			
DH/A4/WF	A4, Wall Fitting	280 x 70 x 400mm	1.4kg
DH/A4/50	A4, 50mm Square Hook	280 x 125 x 405mm	1.4kg
A3 Document Holder			
DH/A3/WF	A3, Wall Fitting	405 x 105 x 400mm	2.9kg
DH/A3/50	A3, 50mm Square Hook	405 x 160 x 405mm	3.0kg



RD2L/D3/CP/D3



RD1/D3/DD/D5

Room Dividers

Features

- Fixed height mobile room divider/workstation
- Ideal for use in critical care areas - A&E, ICU, ICT, HDU
- Modular design allows the unit to be configured to suit your specific requirements
- Frame, worktop & upstand/panel available as...
 - Full width upstand
 - Full width upstand & right hand mounted panel
 - Full width upstand & left hand mounted panel
 - Full width panel
- Four configurations of lower units...
 - Three drawer unit, upper drawer fitted with an electronic push button lock (2 x 170, 1 x 285mm drawers)
 - Five drawer unit, upper drawer fitted with an electronic push button lock (5 x 125mm drawers)
 - Cupboard with double doors & removable shelf
 - Cover panel (creates a space within the unit)
- Easy clean solid grade laminate work surface & upstand/panel
- Upper panel fitted with
 - Triple glove box holder
 - Alcohol gel holder (compatible with 500ml bottles, 70 x 70 x 225mm)
 - Apron roll dispenser
- 100mm ring buffers to protect the fabric of the building
- 100mm swivel castors, 2 off braking

Standard Colours

- Paint - White
- Worksurface / Up-Stand / Panel - White

Dimensions (w x d x h)

- RD1 - 1768 x 698 x 1000mm
- RD2R/RD2L - 1768 x 698 x 1588mm
- RD3 - 1768 x 698 x 1350mm

Options

- CC - Colour coded drawers available on request
- DTSF/RD/450/2 - Dressing Trolley
 - Seamlessly welded 304 grade stainless steel frame
 - Fixed shelves with down turned sides
 - Shelf Heights 375 & 840mm
 - Max load per shelf 40kg

Configure Your Workstation in Four Easy Steps...

1 Select Your Frame

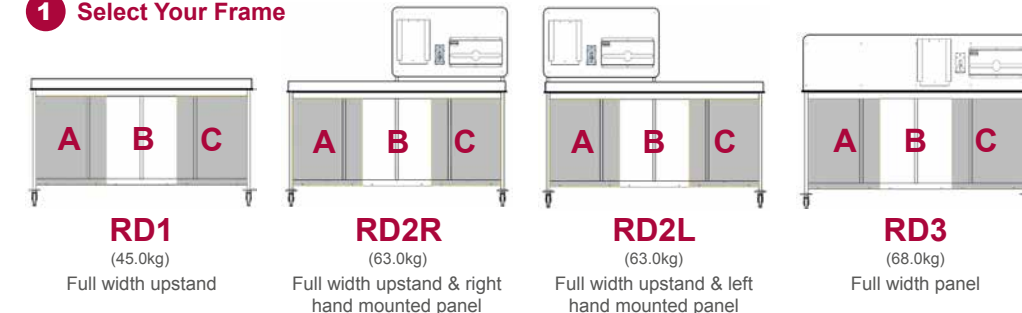

RD1

(45.0kg)

Full width upstand

RD2R

(63.0kg)

Full width upstand & right hand mounted panel

RD2L

(63.0kg)

Full width upstand & left hand mounted panel

RD3

(68.0kg)

Full width panel

2 Select Lower Unit A



D3

(40.0kg)

Three drawer unit, upper drawer fitted with an electronic push button lock (2 x 175, 1 x 285mm)



D5

(45.0kg)

Five drawer unit, upper drawer fitted with an electronic push button lock (5 x 125mm)



DD

(29.0kg)

Cupboard with double doors & removable shelf



CP

(3.0kg)

Cover panel (creates a space within the unit)

3 Select Lower Unit B

4 Select Lower Unit C



RD3/DD/CP/D5/CC configured with DTSF/RD/450/2 & colour coded drawers



RD1 FRAME

D5
LOWER UNIT A

CP
LOWER UNIT B

DD
LOWER UNIT C



WSA/4/C

Curtain Screens - Four Section, Folding

Features

- PVC fire retardant curtain (machine washable)
- Available assembled or for self-assembly
- Overall screen height 1708mm
- Distance from floor to lowest point of screening 288mm
- 50mm twin wheel castors

Dimensions (w x d x h)

- Overall Dimensions - 2450 x 420 x 1790mm
- Folded - 650 x 420 x 1790mm

Standard Colours

- Paint - White
- Curtain - Grey

Options

- WS/SPARES/001 - Set of 4 replacement curtains



Item	Description	Weight
WSA/4/C	Curtain Screen - Four Section, Folding, Assembled	14.6kg
WSK/4/C	Curtain Screen - Four Section, Folding, Self-Assembly	14.6kg

Solid Screens - Three & Four Section, Folding

Features

- Solid plastic screen
- Smooth surface to assist cleaning
- Overall screen height 1680mm
- Distance from floor to lowest point of screening 160mm
- 50mm twin-wheel castors

Dimensions (w x d x h)

- Overall Dimensions
 - Three Section - 1802 x 438 x 1680mm
 - Four Section - 2403 x 438 x 1680mm
- Folded - 600 x 438 x 1680mm

Standard Colours

- Paint - White
- Screen - White



SS/44/H4



SS/44/H3

Item	Description	Weight
SS/44/H3	Solid Screen - Three Section, Folding	20.6kg
SS/44/H4	Solid Screen - Four Section, Folding	27.0kg



Concealment Trolleys

Variable Height Trolleys	84
Fixed Height Trolleys	85
Body Trays & Covers	85

Variable Height - Fixed Body Tray

Features

- Height adjustable, 580 -1280mm to trolley surface
- Scissor action provides vertical lift, ideal for use in confined areas where space is limited
- Battery powered actuator
 - Rechargeable battery is charged through the handset using a UK 3 pin plug
 - Audible warning when battery power is at 50%
- Liquid retaining fixed tray, 1900 x 540 x 25mm
- Drop down side-rails, distance between rails 660mm
- Heavy duty reinforced PVC cover (locates over side rails)
- Bumper bar/push handle at either end
- 200mm heavy duty castors, 2 x braking, 2 x directional locking
- Maximum capacity 190kg

Dimensions (w x d x h)

- Overall Dimensions - 2150 x 770 x 580-1280mm

Standard Colours

- Paint - White



Item	Description	Weight
VH/950	Variable Height, Fixed Body Tray	82.0kg

Variable Height - Loose Body Tray

Features

- Height adjustable, 610 - 1310mm
- Scissor action provides vertical lift, ideal for use in confined areas where space is limited
- Battery powered actuator
 - Rechargeable battery is charged through the handset using a UK 3 pin plug
 - Audible warning when battery power is at 50%
- Liquid retaining loose tray, 2100 x 560 x 70mm
- Tray moves on rollers and is positively locked in position by a spring-loaded clamp at each end of the trolley
- Tray guides adjustable 400-450mm to accommodate trays by others (max width 650mm)
- Drop down side-rails, distance between rails 660mm
- Heavy duty reinforced PVC cover (locates over side rails)
- Bumper bar/push handle at either end
- Compatible with most other common body trays
- 200mm heavy duty castors, 2 x braking, 2 x directional locking
- Maximum capacity 190kg

Dimensions (w x d x h)

- Overall Dimensions - 2270 x 770 x 610 - 1310mm

Standard Colours

- Paint - White



Item	Description	Weight
VH/950/LBT	Variable Height, Loose Body Tray	92.0kg

Fixed Height - Fixed / Loose Body Tray

Features

- Available with fixed or removable liquid retaining trays
 - Fixed Tray
 - Removable Tray - Tray rests on top of frame between support lugs
- Drop down side-rails, distance between rails 660mm
- Heavy duty reinforced PVC cover (locates over side rails)
- Bumper bar/push handle at either end
- 200mm heavy duty castors, 2 x braking, 2 x directional locking
- Maximum capacity 190kg

Standard Colours

- Paint - White



WT/950/DS/LBT



WT/950/DS

Item	Description	Overall Dimensions (w x d x h)	Weight
WT/950/DS	Fixed Height, Fixed Body Tray	2076 x 751 x 690mm	55.0kg
WT/950/DS/LBT	Fixed Height, Loose Body Tray	2076 x 751 x 750mm	61.0kg

Body Tray

Features

- Heavy duty body tray, mild steel frame & stainless steel tray
- Integral runners
- Fits most standard mortuary racks (check prior to ordering)
- Maximum capacity 190kg

Dimensions (w x d x h)

- Overall Dimensions - 2100 x 550 x 70mm

Standard Colours

- Paint - White



Item	Description	Weight
WT/BODY/TRAY	Body Tray	16.0kg

Cover

Features

- Heavy duty reinforced PVC cover (locates over side rails)



Item	Description	Weight
2FACO024	Cover - PVC Heavy Duty Reinforced	5.0kg



Cylinder Storage & Transportation

Cylinder Trolleys - F/G Size	88
Cylinder Trolleys - J Size	89
Bulk Transportation Trolleys	89
Cylinder Trolleys - E, CD/D, AF Size	90
Wall Brackets & Cylinder Holders	91

Cylinder Trolley F/G Size

Features

- Compatible with F (48 cu ft), HX, LF, VF, ZX & G (120 cu ft) cylinders, max diameter 200mm, height 1350mm
- One piece construction
- Drop over chains secure the cylinder
- 160mm anti-static wheels

Dimensions (w x d x h)

- 510 x 405 x 1160mm

Standard Colours

- Paint - Grey



Item	Description	Weight
CYT/FG1	F/G Size	10.0kg

Cylinder Trolley with Stabilisers F/G Size

Features

- Compatible with F (48 cu ft), HX, LF, VF, ZX & G (120 cu ft) cylinders, max diameter 200mm, height 1350mm
- One piece construction
- Drop over chains secure the cylinder
- Stabilising castors at rear of trolley reduce the likelihood of tipping during transportation
- 160mm anti-static wheels, 100mm swivel castors

Dimensions (w x d x h)

- 520 x 700 x 1160mm

Standard Colours

- Paint - Grey



Item	Description	Weight
CYT/FG1/ST	F/G Size	14.0kg

Cylinder Trolley with Stabilisers F/G Size Double

Features

- Compatible with F (48 cu ft), HX, LF, VF, ZX & G (120 cu ft) cylinders, max diameter 200mm, height 1350mm
- One piece construction
- Drop over chains secure the cylinders
- Stabilising castors at rear of trolley reduce the likelihood of tipping during transportation
- 200mm anti-static wheels, 100mm swivel castors

Dimensions (w x d x h)

- 780 x 740 x 1145mm

Standard Colours

- Paint - Grey



Item	Description	Weight
CYT/FG2/ST	F/G Size Double	20.5kg

Cylinder Trolley J Size

Features

- Compatible with J (240 cu ft), AK, L & HL cylinders, max diameter 245mm, height 1550mm
- One piece construction
- Drop over chains secure the cylinder
- 160mm anti-static wheels

Dimensions (w x d x h)

- 510 x 475 x 1280mm

Standard Colours

- Paint - Grey



Item	Description	Weight
CYT/J1	J Size	10.5kg

Cylinder Trolley with Stabilisers J Size

Features

- Compatible with J (240 cu ft), AK, L & HL cylinders, max diameter, max diameter 245mm, height 1550mm
- One piece construction
- Drop over chains secure the cylinder
- Stabilising castors at rear of trolley reduce the likelihood of tipping during transportation
- 160mm anti-static wheels, 100mm swivel castors

Dimensions (w x d x h)

- 510 x 740 x 1275mm

Standard Colours

- Paint - Grey



Item	Description	Weight
CYT/J1/ST	J Size	14.8kg

Bulk Transportation Trolley D & E Cylinders, 12 x Capacity

Features

- Compatible with D, AD, CD, DD, PD, RD, ZD & E (24 cu ft) cylinders (12 x capacity) max diameter 105mm, height 870mm
- One piece construction
- Cylinders locate into individual sections, supported on a non slip rubber base
- 125mm swivel castors, 2 off braking

Dimensions (w x d x h)

- 460 x 590 x 990mm

Standard Colours

- Paint - Grey



Item	Description	Weight
CYT/DE12	D & E Cylinders, 12 x Capacity	23kg

Cylinder Trolley E Size

Features

- Compatible with E (24 cu ft) cylinders, max diameter 115mm, height 900mm
- One piece construction
- Recessed base plate and drop over chain to secure the cylinder
- 40mm hook allows trolley to hang at bed end, a useful feature when transporting patients
- 100mm anti-static wheels

Dimensions (w x d x h)

- 320 x 235 x 980mm

Standard Colours

- Paint - Grey



Item	Description	Weight
CYT/E1	E Size	4.3kg

Cylinder Trolley CD/D Size

Features

- Compatible with CD & D cylinders, max diameter 115mm, height 540mm
- One piece construction
- Recessed base plate and drop over chain to secure the cylinder
- 40mm hook allows trolley to hang at bed end, a useful feature when transporting patients
- 100mm anti-static wheels

Dimensions (w x d x h)

- 320 x 235 x 980mm

Standard Colours

- Paint - Grey



Item	Description	Weight
CYT/CD1	CD/D Size	4.3kg

Cylinder Trolley AF Size

Features

- Compatible with AF, DF & ZH cylinders, max diameter 178mm, height 900mm
- One piece construction
- Recessed base plate and drop over chain to secure the cylinder
- 100mm anti-static wheels

Dimensions (w x d x h)

- 390 x 310 x 980mm

Standard Colours

- Paint - Grey



Item	Description	Weight
CYT/AF1	AF Size	4.9kg

Wall Brackets Cylinder

Features

- Max cylinder diameters
 - D/E - 112mm, F - 148mm, G - 185mm, J - 235mm
- One piece construction
- Drop over chains to secure the cylinder
- Holes for wall mounting (fixings not provided)
- Should be positioned on the wall at approx half cylinder height

Standard Colours

- Paint - Grey



Item	Description	Dimensions (w x d x h)	Weight
CYB/DE2	2 x D/E Cylinders	359 x 107 x 88mm	1.1kg
CYB/F2	2 x F Cylinders	435 x 126 x 88mm	1.4kg
CYB/G2	2 x G Cylinders	511 x 145 x 88mm	1.7kg
CYB/J2	2 x J Cylinders	613 x 170 x 88mm	2.1kg

Cylinder Holder D & E Size, Vertical

Features

- Compatible with...
 - D Size - D, AD, CD, DD, PD, RD & ZD cylinders (max 112mm diameter)
 - E Size - E (max 112mm diameter)
- One piece construction
- Carry handle and extended hook
- Suitable for beds with 25mm wide side/end members
- Holder can be hung and/or bolted to 25mm section bed-frame

Dimensions (w x d x h)

- CYH/D1 - 200 x 160 x 290mm
- CYH/E1 - 200 x 160 x 595mm

Standard Colours

- Paint - Grey



Item	Description	Weight
CYH/D1	D Size, Vertical	1.4kg
CYH/E1	E Size, Vertical	2.5kg

Cylinder Holder Wall Plate

Features

- Painted stainless steel wall plate to support cylinder holders
- Compatible with CYH/D1, CYH/E1, CYHP/D1 & CYHP/E1

Dimensions (w x d x h)

- 240 x 47 x 254mm

Standard Colours

- Paint - Grey



Item	Description	Weight
CYWP/1	Wall Plate	2.1kg



Dispensers, Holders & Racks

Apron Dispensers	94
Pocket Mask Holders	94
Glove Box Holders	95
Alcohol Gel Holders	96
Syringe Dispenser	96
Sharps Box Holder	97
Urine Bottle Holder	97
Catheter Bag Holders	97
Catheter Racks	98
Drainage Racks	99

Apron Dispensers - Roll

Features

- Apron roll holders, maximum width 415mm
- Holes for wall mounting (fixings not provided)

Dimensions (w x d x h)

- One Roll - 420 x 168 x 268mm
- Three Roll - 420 x 168 x 615mm

Standard Colours

- Paint - White



Item	Description	Weight
DAR/1	One Roll	2.0kg
DAR/3	Three Rolls	8.2kg

Apron Dispenser - Flat Pack

Features

- Holder to accept flat packed aprons, maximum width 400mm
- Packs of aprons fold over the centrally positioned divider
- Holes for wall mounting (fixings not provided)

Dimensions (w x d x h)

- 410 x 105 x 290mm

Standard Colours

- Paint - White



Item	Description	Weight
DAF/1	Flat Pack	2.0kg

Pocket Mask Holder

Features

- Holder to accept Laerdal & Ambu Pocket Masks (hard cases)
- Allows the case to be quickly removed from the holder
- Supplied with self adhesive tape/holes for wall mounting (fixings not provided)

Dimensions (w x d x h)

- 110 x 40 x 110mm

Standard Colours

- Paint - White



PMH005 -
Pocket mask
not supplied

PMH005

Item	Description	Weight
PMH005	Pocket Mask Holder	0.1kg

Glove Box Holders

Features

- Plastic coated wire frame
- Available for wall mounting or fitted with a 30mm square hook

Standard Colours

- Paint - White

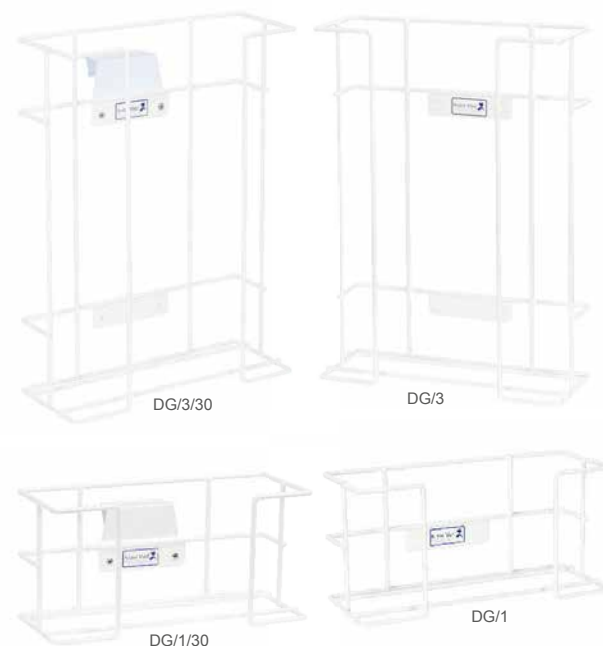

Item	Description	Overall Dimensions (w x d x h)	Weight
One Box			
DG/1	Wall Mounting	290 x 115 x 145mm	0.4kg
DG/1/30	30mm Square Hook	290 x 155 x 145mm	0.5kg
Three Box			
DG/3	Wall Mounting	290 x 115 x 405mm	0.7kg
DG/3/30	30mm Square Hook	290 x 155 x 405mm	0.8kg

Glove / Mask Box Holder One Box, Wall Mounted

Features

- Accommodates glove and mask boxes up to 140mm in width
- One piece construction
- Holes for wall mounting (fixings not provided)

Dimensions (w x d x h)

- 143 x 100 x 152mm

Standard Colours

- Paint - White



Item	Description	Weight
GMBH/WM	One Box, Wall Mounted	0.5kg

Glove Dispenser Three Column, Adjustable

Features

- Packs of sterile gloves separated by two adjustable dividers
- Full width card holder for identification
- Clear front panel assists with stock level inspection
- Hinged lid assists replenishment, whilst top loading ensures stock rotation
- Holes for wall mounting (fixings not provided)

Dimensions (w x d x h)

- 565 x 260 x 315mm

Standard Colours

- Paint - White



Item	Description	Weight
SS/48/3	Three Column, Adjustable	7.0kg

Alcohol Gel Holders - Wire Frame

Features

- Compatible with popular 500ml bottles, 70mm x 70mm x 225mm (not supplied)
- Stainless steel construction
- Plastic drip tray
- Available with holes for wall mounting (fixings not provided) or with a 30mm square hook

Standard Colours

- Stainless Steel



Item	Description	Overall Dimensions (w x d x h)	Weight
GH005	Lever Operated, Wall Mounted, Angled	77 x 300 x 278mm	0.4kg
GH015	30mm Hook	77 x 117 x 180mm	0.3kg

Syringe Dispenser - Five Column, Adjustable

Features

- Syringes separated by four adjustable dividers
- Full width card holder for identification
- Clear front panel assists with stock level inspection
- Hinged lid assists replenishment, whilst top loading ensures stock rotation
- Holes for wall mounting (fixings not provided)

Dimensions (w x d x h)

- 565 x 317 x 320mm

Standard Colours

- Paint - White



Item	Description	Weight
SS/36	Five Column, Adjustable	9.2kg

Sharps Box Holder One Box, Wall Mounted

Features

- Accepts sharps boxes up to seven litres capacity
- Sharps box secured using a rubber band fitted with a toggle
- Holes for wall mounting (fixings not provided)

Dimensions (w x d x h)

- 127 x 100 x 190mm

Standard Colours

- Paint - White



Item	Description	Weight
SBH/WM	One Box, Wall Mounted	0.4kg

Urine Bottle Holder Hanging

Features

- Compatible with bottles up to 115mm Diameter
- Plastic coated wire frame
- 30mm square hook

Dimensions (w x d x h)

- 150 x 182 x 282mm

Standard Colours

- Plastic - White



Item	Description	Weight
UB/9	Urine Bottle	0.3kg

Catheter Bag Holders Free Standing/Hanging

Features

- Plastic coated wire frame
- Accepts most widely used bags
- Available freestanding or hanging (30mm square hook)
- Upper clip to hold the inlet tube
- Lower clip angles the drainage tube upwards to prevent drips should the tap leak

Standard Colours

- Plastic - White



Item	Description	Overall Dimensions (w x d x h)	Weight
UB005	Freestanding	250 x 250 x 550mm	0.6kg
UB010	Hanging	250 x 77 x 410mm	0.4kg

Catheter Racks - Two & Five Section

Features

- Internal dimensions of each section 65 x 75 x 405mm
- Removable clear perspex panel to aid cleaning
- Available with holes for wall mounting (fixings not provided) or with a 15mm square hook

Standard Colours

- Paint - White



Item	Description	Overall Dimensions (w x d x h)	Weight
Two Section			
RC/2	Wall Fitting	135 x 85 x 410mm	1.3kg
RC/2/15	15mm Hook	135 x 115 x 410mm	1.4kg
Five Section			
RC/5	Wall Fitting	320 x 85 x 410mm	3.3kg
RC/5/15	15mm Hook	320 x 115 x 410mm	3.4kg

Catheter Racks - One Section

Features

- Outer sleeve removable for cleaning
- 20mm square hook

Dimensions (w x d x h)

- 185 x 55 x 555mm

Standard Colours

- Paint - White



Item	Description	Weight
SS/40/MS	One Section	2.0kg

Drainage Racks - Urinal

Features

- Holds five urine bottles
- Stainless steel construction
- Supplied with a stainless steel drip tray
- Holes for wall mounting (fixings not provided)

Dimensions (w x d x h)

- 535 x 205 x 415mm

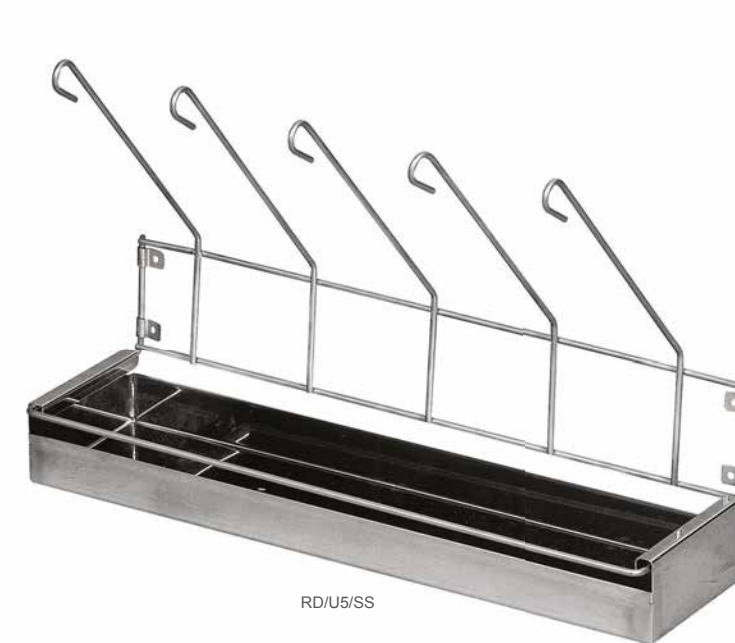

Item	Description	Weight
RD/U5/SS	Urinal, Stainless Steel	1.7kg

Drainage Racks - Bedpan

Features

- Holds five bedpans
- Stainless steel construction
- Supplied with a stainless steel drip tray
- Holes for wall mounting (fixings not provided)

Dimensions (w x d x h)

- 530 x 295 x 375mm



Item	Description	Weight
RD/B5/SS	Bedpan, Stainless Steel	3.3kg

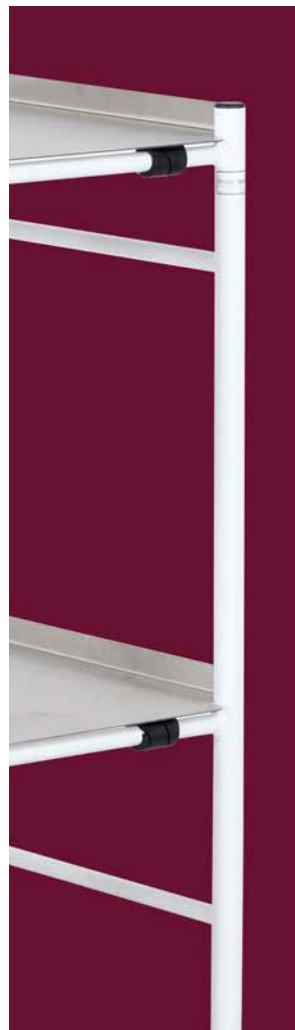

Dressing Instrument Trolleys

Removable Shelves, Stainless Steel	102
Removable Shelves, Mild Steel	103
Fixed Shelves, Sides Up	104
Fixed Shelves, Sides Down	105
Drawer Units	107
Options	108



Removable Shelves, Stainless Steel, 450mm Deep

Features

- Meets BS4068:1977 Specification for hospital trolleys for instruments, dressings & for anaesthetists' use
- Seamlessly welded from 304 grade stainless steel for strength & ease of cleaning
- Flat or reversible 304 grade stainless steel shelves, cushioned on anti-static spiral buffers (removable for cleaning)
- Reversible shelves allow the end user to choose between a flat shelf or a shelf with three upturned sides
- Shelf heights 405 & 870mm
- Maximum capacity per shelf 40kg
- 75mm pressed steel non-marking castors (1 x anti-static, 3 x non-anti-static)

Options

- C001 - 80mm, Grey Polymer Castors (2 x braking / 2 x non-braking)
- C002 - 100mm, Grey Polymer Castors (2 x braking / 2 x non-braking)
- C003 - 100mm, Pressed Steel Castors (2 x braking / 2 x non-braking)
- C013 - 75mm, Pressed Steel Castors (4 x braking)
- Drawer Units - Range of sizes / configurations (see page 107)
- DP/C - Infusion Pole & Bracket
- ZP005 - Ring Buffers

Flat Shelves	Reversible Shelves	Size	Shelf Size (w x d)	Overall Dimensions (w x d x h)	Weight
DTSR/450	DTSR/450/SR	Small	450 x 450mm	470 x 470 x 890mm	11.5kg
DTSR/600	DTSR/600/SR	Medium	600 x 450mm	620 x 470 x 890mm	16.0kg
DTSR/750	DTSR/750/SR	Large	750 x 450mm	770 x 470 x 890mm	18.0kg
DTSR/900	DTSR/900/SR	X-Large	900 x 450mm	920 x 470 x 890mm	20.0kg

Removable Shelves, Mild Steel, 450mm Deep

Features

- Meets BS4068:1977 Specification for hospital trolleys for instruments, dressings & for anaesthetists' use
- Seamlessly welded mild steel frame
- Flat or reversible 304 grade stainless steel shelves, cushioned on anti-static spiral buffers (removable for cleaning)
- Reversible shelves allow the end user to choose between a flat shelf or a shelf with three upturned sides
- Shelf heights 405 & 870mm
- Maximum capacity per shelf 40kg
- 75mm pressed steel non-marking castors (1 x anti-static, 3 x non-anti-static)

Standard Colours

- Paint - White

Options

- C001 - 80mm, Grey Polymer Castors (2 x braking / 2 x non-braking)
- C002 - 100mm, Grey Polymer Castors (2 x braking / 2 x non-braking)
- C003 - 100mm, Pressed Steel Castors (2 x braking / 2 x non-braking)
- C013 - 75mm, Pressed Steel Castors (4 x braking)
- Drawer Units - Range of sizes / configurations (see page 107)
- DP/C - Infusion Pole & Bracket
- ZP005 - Ring Buffers

Flat Shelves	Reversible Shelves	Size	Shelf Size (w x d)	Overall Dimensions (w x d x h)	Weight
DTMR/450	DTMR/450/SR	Small	450 x 450mm	470 x 470 x 890mm	11.5kg
DTMR/600	DTMR/600/SR	Medium	600 x 450mm	620 x 470 x 890mm	16.0kg



Fixed Shelves, Sides Up, Stainless Steel, 450mm Deep

Features

- Meets BS4068:1977 Specification for hospital trolleys for instruments, dressings & for anaesthetists' use
- Seamlessly welded from 304 grade stainless steel for strength & ease of cleaning
- Fixed shelves with three sides up & one down
- Shelf heights 405 & 870mm
- Maximum capacity per shelf 40kg
- 75mm pressed steel non-marking castors (1 x anti-static, 3 x non-anti-static)

Options

- C001 - 80mm, Grey Polymer Castors (2 x braking / 2 x non-braking)
- C002 - 100mm, Grey Polymer Castors (2 x braking / 2 x non-braking)
- C003 - 100mm, Pressed Steel Castors (2 x braking / 2 x non-braking)
- C013 - 75mm, Pressed Steel Castors (4 x braking)
- Drawer Units - Range of sizes / configurations (see page 107)
- DP/C - Infusion Pole & Bracket
- ZP005 - Ring Buffers



Item	Size	Shelf Size (w x d)	Overall Dimensions (w x d x h)	Weight
DTSF/450	Small	450 x 450mm	470 x 470 x 890mm	11.5kg
DTSF/600	Medium	600 x 450mm	620 x 470 x 890mm	16.0kg
DTSF/750	Large	750 x 450mm	770 x 470 x 890mm	18.0kg
DTSF/900	X-Large	900 x 450mm	920 x 470 x 890mm	20.0kg

Fixed Shelves, Sides Down, Stainless Steel, 450mm Deep

Features

- Meets BS4068:1977 Specification for hospital trolleys for instruments, dressings & for anaesthetists' use
- Seamlessly welded from 304 grade stainless steel for strength & ease of cleaning
- Fixed shelves with down turned sides
- Shelf heights 405 & 870mm
- Maximum capacity per shelf 40kg
- 75mm pressed steel non-marking castors (1 x anti-static, 3 x non-anti-static)

Options

- C001 - 80mm, Grey Polymer Castors (2 x braking / 2 x non-braking)
- C002 - 100mm, Grey Polymer Castors (2 x braking / 2 x non-braking)
- C003 - 100mm, Pressed Steel Castors (2 x braking / 2 x non-braking)
- C013 - 75mm, Pressed Steel Castors (4 x braking)
- Drawer Units - Range of sizes / configurations (see page 107)
- DP/C - Infusion Pole & Bracket
- ZP005 - Ring Buffers



Item	Size	Shelf Size (w x d)	Overall Dimensions (w x d x h)	Weight
DTSF/450/2/SD	Small	450 x 450mm	470 x 470 x 870mm	12.0kg
DTSF/600/2/SD	Medium	600 x 450mm	620 x 470 x 870mm	14.5kg
DTSF/750/2/SD	Large	750 x 450mm	770 x 470 x 870mm	18.0kg
DTSF/900/2/SD	X-Large	900 x 450mm	920 x 470 x 870mm	21.0kg

Fixed Shelves, Sides Down, Stainless Steel, 600mm Deep



Features

- Meets BS4068:1977 Specification for hospital trolleys for instruments, dressings & for anaesthetists' use
- Seamlessly welded from 304 grade stainless steel for strength & ease of cleaning
- Fixed shelves with down turned sides
- Shelf heights 405 & 870mm
- Maximum capacity per shelf 40kg
- 100mm pressed steel anti-static non-marking castors

Options

- C002 - 100mm, Grey Polymer Castors (2 x braking / 2 x non-braking)
- C003 - 100mm, Pressed Steel Castors (2 x braking / 2 x non-braking)
- C015 - 100mm, Pressed Steel Castors (4 x braking)
- DP/C - Infusion Pole & Bracket
- ZP005 - Ring Buffers

Item	Size	Shelf Size (w x d)	Overall Dimensions (w x d x h)	Weight
DTSF/66/2/SD	Small	600 x 600mm	620 x 620 x 870mm	17.5kg
DTSF/96/2/SD	Medium	900 x 600mm	920 x 620 x 870mm	24.0kg
DTSF/126/2/SD	Large	1200 x 600mm	1220 x 620 x 870mm	29.6kg

Drawer Units

Features

- Compatible with removable & fixed shelf ranges, with exception of 600mm deep trolleys
- Available in three widths...
 - DRW260 - Set of two drawers
 - DRW350 - Single drawer
 - DRW650 - Single drawer
- Maximum capacity 10.0kg
- Factory fitted & must be ordered at the same time as the trolley

Internal Dimensions (w x d x h)

- DRW260 - 230 x 410 x 100mm
- DRW350 - 350 x 410 x 100mm
- DRW650 - 650 x 410 x 100mm



DTSR/750 with DRW260/R/DRW260

Removable Shelf Trolleys

Trolley Width	One Tier Combination Code			Two Tier Combination Code		
	DRW260/R	DRW350/R	DRW650/R	DRW260/R DRW260	DRW350/R DRW350	DRW650/R DRW650
450mm						
600mm	✓	✓		✓	✓	
750mm	✓	✓	✓	✓	✓	✓
900mm	✓	✓	✓	✓	✓	✓

Fixed Shelf Trolleys

Trolley Width	DRW260/F	DRW350/F	DRW650/F	DRW260/F DRW260	DRW350/F DRW350	DRW650/F DRW650
	450mm					
600mm	✓	✓		✓	✓	
750mm	✓	✓	✓	✓	✓	✓
900mm	✓	✓	✓	✓	✓	✓

Castors

Features

- Polymer & pressed steel castors
- Anti-static & non-marking
- Supplied as a set of 4 castors
- 80mm polymer castors increase the height of the trolley by approx. 5mm
- 100mm polymer castors increase the height of the trolley by approx. 30mm
- 100mm steel castors increase the height of the trolley by approx. 30mm
- Factory fitted



Item	Description
C001	Castor - 80mm, Grey Polymer, 2 x Braking / 2 x Non-Braking (set of 4)
C002	Castor - 100mm, Grey Polymer, 2 x Braking / 2 x Non-Braking (set of 4)
C003	Castor - 100mm, Pressed Steel, 2 x Braking / 2 x Non-Braking (set of 4)
C013	Castor - 75mm, Pressed Steel (4 x braking)
C015	Castor - 100mm, Pressed Steel (4 x braking)

Reversible Shelves

Features

- Allows the end user to choose between a flat shelf or one with three upturned sides
- Removable for cleaning
- Compatible with DTMR & DTSR ranges only



Item	Description	Weight
SR	Reversible Shelves	5-10kg

Clamping Infusion Stands - Trolley

Features

- Clamp secures to 25mm vertical round tube (designed to fit our range of dressing trolleys)
- When fitting to other trolleys, we strongly recommend that a risk assessment is carried out to assess stability
- When fitted protrudes 45mm
- Supplied with a two pigtail hook infusion pole
- Maximum capacity on hooks 2kg

Dimensions (w x d x h)

- 55 x 220 x 1200mm



Item	Description	Weight
DP/C	Clamping Infusion Stands - Trolley	1.8kg

Ring Buffers

Features

- Set of four ring buffers
- Offers protection to both the trolley & fabric of the building
- Increases the length & width of trolley by approx. 80mm
- Factory fitted



Item	Description	Weight
ZP005	Ring Buffers (set of four)	0.3kg



Drug & Medicine Dispensing

Dispensing Trolleys	112
CLIQ® & RFID Solutions	115
Patient Administration Trolleys	116
Drawer Trolleys	118
Tray Trolleys	119
Blister Pack (MDS) Trolleys	120
Nomad® Cassette Trolleys	122
Biodose® & MultiMeds Trolleys	124
Medinox Trolleys	125
Laptop Holders	126
Security Clamp	128
Distribution Trolleys	129



MT100

Dispensing Trolleys - Wooden, Standard Capacity

Features

- Trolleys suitable for the storage & dispensing of drugs & medicines
- Lockable hinged lids
 - Upper - Assisted using a gas strut, providing document support
 - Lower - Provides a work area, at height 980mm (max capacity 4.0kg)
- Available with either an electronic push button or high security bolt lock
 - Electronic Push Button - Uses a four digit code (available with master/submaster/user & technicians codes)
 - High Security Bolt Lock - Supplied with two keys
- Hinged writing flap provides a work area at height 930mm (max capacity 2.0kg)
- Lower shelf
- Five tier plastic rack (395mm)
- Two slide out storage / waste bins
- 100mm swivel pressed steel castors
- When not in use, trolley should be secured to the building - see optional MT/1/6F

Dimensions (w x d x h)

- Overall...
 - Small - 750 x 490 x 1130mm
 - Medium - 890 x 490 x 1130mm
 - Large - 1030 x 525 x 1130mm
- Internal...
 - Small - 530 x 427 x 263mm sloping to 112mm at front
 - Medium - 683 x 427 x 263mm sloping to 112mm at front
 - Large - 805 x 461 x 263mm sloping to 112mm at front

Standard Colours

- Paint - Grey White
- Cabinet/Shelf/Flap - Spearmint/White

Options

- MT/1/6F - Security Wall Clamp
- ZP005 - Ring Buffers

Item	Description	Weight
High Security Bolt Lock		
MT100	Small, High Security Bolt Lock	26.0kg
MT110	Medium, High Security Bolt Lock	35.0kg
MT120	Large, High Security Bolt Lock	42.5kg
Electronic Push Button Lock		
MT100CL	Small, Electronic Push Button Lock	26.0kg
MT110CL	Medium, Electronic Push Button Lock	35.0kg
MT120CL	Large, Electronic Push Button Lock	42.5kg

Dispensing Trolleys - Wooden, High Capacity

Features

- Trolleys suitable for the storage & dispensing of drugs & medicines
- Lockable hinged lids
 - Upper - Assisted using a gas strut, providing document support
 - Lower - Provides a work area, at height 921mm (max capacity 4.0kg)
- Available with either an electronic push button or high security bolt lock
 - Electronic Push Button - Uses a four digit code (available with master/submaster/user & technicians codes)
 - High Security Bolt Lock - Supplied with two keys
- Hinged writing flap provides a work area at height 850mm (max capacity 2.0kg)
- Lower shelf
- Five tier plastic rack (395mm)
- Three angled shelves, complete with six adjustable U shaped dividers
- Two slide out storage / waste bins
- Ring buffers
- 125mm swivel pressed steel castors
- When not in use, trolley should be secured to the building - see optional MT/1/6F

Dimensions (w x d x h)

- Overall...
 - Medium - 760 x 560 x 1290mm
 - Large - 905 x 560 x 1290mm
- Internal...
 - Medium - 530 x 461 x 513mm sloping to 137mm at the front
 - Large - 683 x 461 x 513mm sloping to 137mm at the front

Standard Colours

- Paint - Grey White
- Cabinet/Shelf/Flap - Spearmint/White

Options

- MT/1/6F - Security Wall Clamp

Item	Description	Weight
High Security Bolt Lock		
MT220	Medium, High Security Bolt Lock	42.0kg
MT230	Large, High Security Bolt Lock	50.0kg
Electronic Push Button Lock		
MT220CL	Medium, Electronic Push Button Lock	42.0kg
MT230CL	Large, Electronic Push Button Lock	50.0kg



MT220



MT140

Dispensing Trolleys - Metal, Standard Capacity

Features

- Trolleys suitable for the storage & dispensing of drugs & medicines
- Lockable hinged lid provides document support
- Fitted with a high security bolt lock (supplied with two keys)
- Hinged writing flap provides a work area at height 907mm (max capacity 2.0kg)
- Lower shelf
- Five tier plastic rack (395mm)
- Two slide out storage / waste bins
- 100mm swivel pressed steel castors
- When not in use, trolley should be secured to the building - see optional MT/1/6F

Dimensions (w x d x h)

- Overall...
 - Small - 750 x 459 x 1112mm
 - Medium - 891 x 459 x 1112mm
 - Large - 1030 x 492 x 1112mm
- Internal...
 - Small - 489 x 457 x 292mm sloping to 127mm at the front
 - Medium - 706 x 457 x 292mm sloping to 127mm at the front
 - Large - 832 x 490 x 292mm sloping to 127mm at the front

Standard Colours

- Paint - Grey White
- Shelf/Flap - Spearmint

Options

- MT/1/6F - Security Wall Clamp
- ZP005 - Ring Buffers



Alternative Colours
Page 410

Item	Description	Weight
MT130	Small, High Security Bolt Lock	22.0kg
MT140	Medium, High Security Bolt Lock	25.0kg
MT150	Large, High Security Bolt Lock	31.0kg

CLIQ® & RFID Solutions

The use of CLIQ® coupled with unique RFID tag identifiers allows a single key to be used with Medicines Management and for Accessing Patient Records.

- Controlled Drug Cabinets (audit trail available)
- Drug & Medicine Cabinets (audit trail available)
- Self-Administration Cabinets
- Bedside Cabinets
- Drug & Medicine Dispensing Trolleys
- Medical Records Trolleys

The use of RFID cards allows a single card to be used with Self-Administration Schemes.

- Self-Administration Cabinets
- Bedside Cabinets

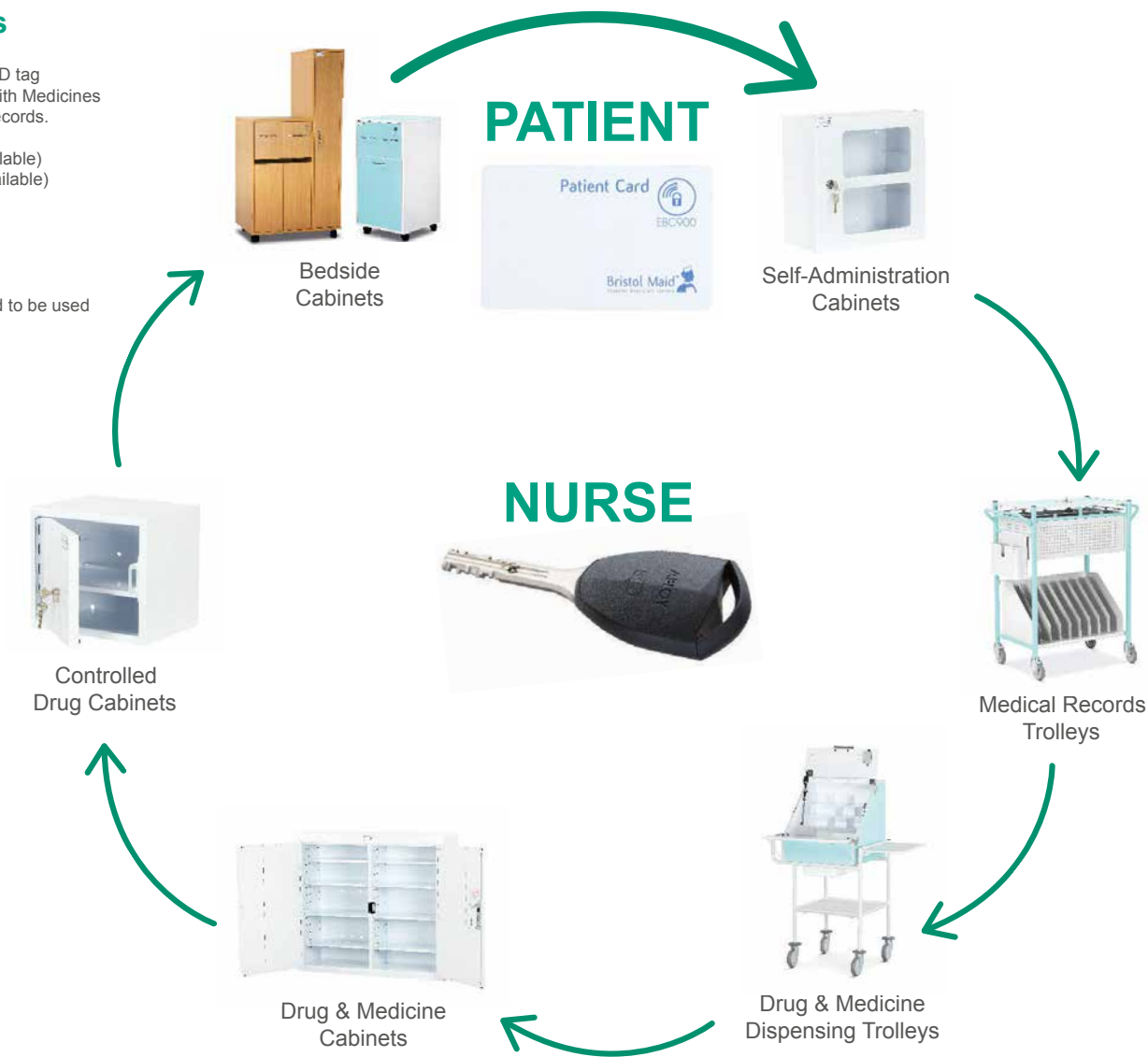



PTS/HSB/PA24

Pharmacy Trolleys - Patient Administration

Features

- Trolleys suitable for the storage & dispensing of drugs & medicines using individual compartments dedicated for each patient
- Available with either an electronic push button or high security bolt lock
 - Electronic Push Button - Uses a four digit code (available with master/submaster/user & technicians codes)
 - High Security Bolt Lock - Supplied with two keys
- Trolleys supplied with 4 / 8 trays subdivided into equal compartments
 - 24 Compartment - Trolley supplied with 4 trays subdivided into 6 equal compartments, each compartment - 190mm x 132mm x 220mm (5.5 Litres). Label holders provided for each compartment
 - 32 Compartment - Trolley supplied with 8 trays subdivided into 4 equal compartments, each compartment - 192mm x 143mm x 220mm (6.1 Litres). Label holders provided for each compartment
- Upper work surface
- Push handles incorporate integral buffers to protect the fabric of the building
- Plastic debris bin & bracket
- 125mm polymer castors offer reduced rolling resistance making the trolley easier to manoeuvre, lowers noise levels, whilst smooth surfaces assist cleaning
- When not in use, trolley should be secured to the building - see optional MT/1/6F

Dimensions (w x d x h)

- Single Door - 627 x 579 x 1165mm
- Double Door - 820 x 579 x 1165mm

Standard Colours

- Paint - Grey
- Work Surface - Spearmint

Options

- MT/1/6F - Security Wall Clamp
- PT/LHR/S - Laptop Holder - Removable, Swing Arm
- PT/LHNR/S - Laptop Holder - Non-Removable, Swing Arm
- PT/LH/C5 - Motion C5 Holder



PTS/EPB/PA24

Single Door

High Security Bolt Lock	Electronic Push Button Lock	Description	Weight
PTS/HSB/PA24	PTS/EPB/PA24	Patient Administration, 24 Compartments	51.4kg



PTD/HSB/PA32

Double Door

High Security Bolt Lock	Electronic Push Button Lock	Description	Weight
PTD/HSB/PA32	PTD/EPB/PA32	Patient Administration, 32 Compartments	68.8kg

Trays tilt to assist access to contents



PTS/HSB/PA24



PTD/HSB/PA32



PTS/HSB/DR6

Pharmacy Trolleys - Drawers

Features

- Trolleys suitable for the storage & dispensing of drugs & medicines using drawers
- Available with either an electronic push button or high security bolt lock
 - Electronic Push Button - Uses a four digit code (available with master/submaster/user & technicians codes)
 - High Security Bolt Lock - Supplied with two keys
- Internal drawer dimensions - 335 x 295 x 113mm (w x d x h)
- Upper work surface
- Push handles incorporate integral buffers to protect the fabric of the building
- Adjustable door shelves
 - Single Door - 3 door shelves
- Plastic debris bin & bracket
- 125mm polymer castors offer reduced rolling resistance making the trolley easier to manoeuvre, lowers noise levels, whilst smooth surfaces assist cleaning
- When not in use, trolley should be secured to the building - see optional MT/1/6F

Dimensions (w x d x h)

- 511 x 542 x 1072mm

Standard Colours

- Paint - Grey
- Work Surface - Spearmint

Options

- MT/1/6F - Security Wall Clamp
- PT/LHR/S - Laptop Holder - Removable, Swing Arm
- PT/LHNR/S - Laptop Holder - Non-Removable, Swing Arm
- PT/LH/C5 - Motion C5 Holder - Swing Arm



PTS/EPB/DR6

Item	Description	Weight
PTS/HSB/DR6	High Security Bolt Lock, Six Drawers	53.0kg
PTS/EPB/DR6	Electronic Push Button Lock, Six Drawers	53.0kg

Pharmacy Trolleys - Trays

Features

- Trolleys suitable for the storage & dispensing of drugs & medicines using individual patient trays supported on adjustable shelves
- Available with either an electronic push button or high security bolt lock
 - Electronic Push Button - Uses a four digit code (available with master/submaster/user & technicians codes)
 - High Security Bolt Lock - Supplied with two keys
- Trays supported on adjustable shelves
- Tray Sizes (w x d x h)
 - LA - 86 x 268 x 57mm (aluminium)
 - A - 85 x 181 x 54mm (plastic)
 - C - 129 x 181 x 54mm (plastic)
 - LP - 115 x 266 x 95mm (plastic)
- Upper work surface
- Push handles incorporate integral buffers to protect the fabric of the building
- Adjustable door shelves
 - Single Door - 3 door shelves
 - Double Door - 6 door shelves
- Plastic debris bin & bracket
- 125mm polymer castors offer reduced rolling resistance making the trolley easier to manoeuvre, lowers noise levels, whilst smooth surfaces assist cleaning
- When not in use, trolley should be secured to the building - see optional MT/1/6F

Dimensions (w x d x h)

- Single Door - 511 x 542 x 1072mm
- Double Door - 711 x 568 x 1072mm

Standard Colours

- Paint - Grey
- Work Surface - Spearmint

Options

- MT/1/6F - Security Wall Clamp
- PT/LHR/S - Laptop Holder - Removable, Swing Arm
- PT/LHNR/S - Laptop Holder - Non-Removable, Swing Arm
- PT/LH/C5 - Motion C5 Holder - Swing Arm

High Security Bolt Lock	Electronic Push Button Lock	Description	Weight
Single Door			
PTS/HSB/LA16	PTS/EPB/LA16	Sixteen LA Trays	39.0kg
Double Door			
PTD/HSB/A18C12	PTD/EPB/A18C12	Eighteen A & Twelve C Trays	57.0kg
PTD/HSB/LP24	PTD/EPB/LP24	Twenty Four LP Trays	57.0kg



PTD/HSB/LP24



PTS/HSB/LA16



PTD/HSB/A18C12



PTS/HSB/DR/BP6



PTS/EPB/BP4



PTS/HSB/BP6
(frames not included)



PTS/HSB/BP4
(frames not included)

Pharmacy Trolleys - Blister Pack (MDS)

Features

- Trolleys suitable for the storage & dispensing of drugs & medicines using the blister packed monitored dosage system (MDS)
- Available with either an electronic push button or high security bolt lock
 - Electronic Push Button - Uses a four digit code (available with master/submaster/user & technicians codes)
 - High Security Bolt Lock - Supplied with two keys
- Frames supported on either a fixed panel mounted to the inside rear of the trolley or on three adjustable slide out shelves (frames not supplied)
- Upper work surface
- Push handles incorporate integral buffers to protect the fabric of the building
- Adjustable door shelves
 - Single Door - 3 door shelves
 - Double Door - 6 door shelves
- Fold over MDS dispensing surface
- Plastic debris bin & bracket
- Lower drawer (refer to table for models)
 - Single Door - 335 x 295 x 66mm
 - Double Door - 535 x 324 x 66mm
- 125mm polymer castors offer reduced rolling resistance making the trolley easier to manoeuvre, lowers noise levels, whilst smooth surfaces assist cleaning
- When not in use, trolley should be secured to the building - see optional MT/1/6F

Dimensions (w x d x h)

- Single Door - 511 x 542 x 1072mm
- Double Door - 711 x 568 x 1072mm

Standard Colours

- Paint - Grey
- Work Surface - Spearmint

Options

- MT/1/6F - Security Wall Clamp
- PT/LHR/S - Laptop Holder - Removable, Swing Arm
- PT/LHNR/S - Laptop Holder - Non-Removable, Swing Arm
- PT/LH/C5 - Motion C5 Holder - Swing Arm

Single Door

High Security Bolt Lock	Electronic Push Button Lock	Description	Weight
PTS/HSB/BP4	PTS/EPB/BP4	Blister Pack, Four Frames	31.0kg
PTS/HSB/BP6	PTS/EPB/BP6	Blister Pack, Six Frames	38.0kg
PTS/HSB/DR/BP6	PTS/EPB/DR/BP6	Drawer, Blister Pack, Six Frames	39.0kg

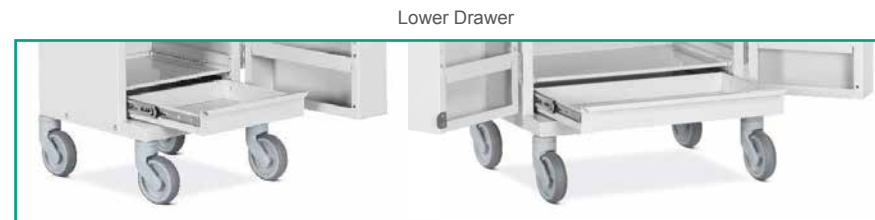

PTS/HSB/DR/BP6

PTD/HSB/DR/BP9



PTD/HSB/BP6
(frames not included)



PTD/HSB/BP9
(frames not included)



PTD/HSB/DR/BP9

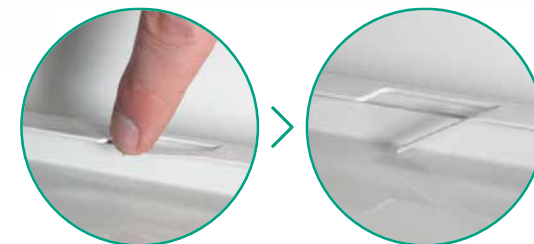

Tab prevents the shelf from being removed

Double Door

High Security Bolt Lock	Electronic Push Button Lock	Description	Weight
PTD/HSB/BP6	PTD/EPB/BP6	Blister Pack, Six Frames	38.0kg
PTD/HSB/BP9	PTD/EPB/BP9	Blister Pack, Nine Frames	42.0kg
PTD/HSB/DR/BP9	PTD/EPB/DR/BP9	Drawer, Blister Pack, Nine Frames	46.0kg



PTS/HSB/NC30
(cassettes not included)

Pharmacy Trolleys - Nomad® Cassettes

Features

- Trolleys suitable for the storage & dispensing of drugs & medicines using the Nomad® cassette monitored dosage system
- Available with either an electronic push button or high security bolt lock
 - Electronic Push Button - Uses a four digit code (available with master/submaster/user & technicians codes)
 - High Security Bolt Lock - Supplied with two keys
- Cassettes supported on three adjustable shelves
- Upper work surface
- Push handles incorporate integral buffers to protect the fabric of the building
- Adjustable door shelves
 - Single Door - 3 door shelves
 - Double Door - 6 door shelves
- Plastic debris bin & bracket
- 125mm polymer castors offer reduced rolling resistance making the trolley easier to manoeuvre, lowers noise levels, whilst smooth surfaces assist cleaning
- When not in use, trolley should be secured to the building - see optional MT/1/6F

Dimensions (w x d x h)

- Single Door - 511 x 542 x 1072mm
- Double Door - 711 x 568 x 1072mm

Standard Colours

- Paint - Grey
- Work Surface - Spearmint

Options

- MT/1/6F - Security Wall Clamp
- PT/LHR/S - Laptop Holder - Removable, Swing Arm
- PT/LHNR/S - Laptop Holder - Non-Removable, Swing Arm
- PT/LH/C5 - Motion C5 Holder - Swing Arm



PTS/EPB/NC30

Single Door

High Security Bolt Lock	Electronic Push Button Lock	Description	Weight
PTS/HSB/NC30	PTS/EPB/NC30	Nomad®, Thirty Cassettes	38.0kg



PTD/HSB/NC56
(cassettes not included)

Double Door

High Security Bolt Lock	Electronic Push Button Lock	Description	Weight
PTD/HSB/NC56	PTD/EPB/NC56	Nomad®, Fifty Six Cassettes	48.0kg



PTD/EPB/NC56



PTD/HSB/BD69
(trays not included)

PTS/EPB/BD46
(trays not included)

Pharmacy Trolleys - Biodose® & MultiMeds

Features

- Trolleys suitable for the storage & dispensing of drugs & medicines using the Biodose® & MultiMeds monitored dosage system
- Available with either an electronic push button or high security bolt lock
 - Electronic Push Button - Uses a four-digit code (available with master/submaster/user & technicians codes)
 - High Security Bolt Lock - Supplied with two keys
- Trays supported on fixed runners (trays not supplied)
- Upper work surface
- Push handles incorporate integral buffers to protect the fabric of the building
- Adjustable door shelves
 - Single Door - 3 door shelves
 - Double Door - 6 door shelves
- Plastic debris bin & bracket
- 125mm polymer castors offer reduced rolling resistance making the trolley easier to manoeuvre, lowers noise levels, whilst smooth surfaces assist cleaning
- When not in use, trolley should be secured to the building - see optional MT/1/6F

Dimensions (w x d x h)

- Single Door - 581 x 568 x 1072mm
- Double Door - 812 x 568 x 1072mm

Standard Colours

- Paint - Grey
- Work Surface - Spearmint

Options

- MT/1/6F - Security Wall Clamp
- PT/LHR/S - Laptop Holder - Removable, Swing Arm
- PT/LHNR/S - Laptop Holder - Non-Removable, Swing Arm
- PT/LH/C5 - Motion C5 Holder - Swing Arm

High Security Bolt Lock	Electronic Push Button Lock	Description	Weight
Single Door			
PTS/HSB/BD46	PTS/EPB/BD46	Biodose® & MultiMeds, 46 Trays	37.3kg
Double Door			
PTD/HSB/BD69	PTD/EPB/BD69	Biodose® & MultiMeds, 69 Trays	52.0kg

Pharmacy Trolleys - Medinox

Features

- Trolleys suitable for the storage & dispensing of drugs & medicines using the Medinox monitored dosage system (compatible with 7 x 4 medi-trays)
- Available with either an electronic push button or high security bolt lock
 - Electronic Push Button - Uses a four-digit code (available with master/submaster/user & technicians codes)
 - High Security Bolt Lock - Supplied with two keys
- Trays supported on fixed runners (trays not supplied)
- Upper work surface
- Push handles incorporate integral buffers to protect the fabric of the building
- Adjustable door shelves
 - Single Door - 3 door shelves
 - Double Door - 6 door shelves
- Plastic debris bin & bracket
- 125mm polymer castors offer reduced rolling resistance making the trolley easier to manoeuvre, lowers noise levels, whilst smooth surfaces assist cleaning
- When not in use, trolley should be secured to the building - see optional MT/1/6F

Dimensions (w x d x h)

- Single Door - 581 x 568 x 1072mm
- Double Door - 812 x 568 x 1072mm

Standard Colours

- Paint - Grey
- Work Surface - Spearmint

Options

- MT/1/6F - Security Wall Clamp
- PT/LHR/S - Laptop Holder - Removable, Swing Arm
- PT/LHNR/S - Laptop Holder - Non-Removable, Swing Arm
- PT/LH/C5 - Motion C5 Holder - Swing Arm

High Security Bolt Lock	Electronic Push Button Lock	Description	Weight
Single Door			
PTS/HSB/MX40	PTS/EPB/MX40	Medinox, 40 Trays	41.4kg
Double Door			
PTD/HSB/MX60	PTD/EPB/MX60	Medinox, 60 Trays	55.2kg



PTD/EPB/MX60
(trays not included)



PTS/EPB/MX40

PTS/HSB/MX40
(trays not included)



Laptop Holder - Removable, Swing Arm

Features

- Three section swing arm offering height, rotation & angle adjustment
- Compatible with the PT range of single & double door pharmacy trolleys
- Laptop holder fitted to an upright bolted to the rear left hand corner of the trolley (upright & holder supplied for customer to fit)
- Adjustable to accept laptops 280-435 x 22mm (w x h)
- Maximum capacity 2.0kg
- Laptop supported in a cradle fitted with adjustable wing arms
- Laptop can be secured using a security clamp (supplied)*
- Design allows easy access to laptop ports

*Not compatible with the Dell laptops using the N17 wedge lock system

Standard Colours

- Paint - Grey

Item	Description	Weight
PT/LHR/S	Removable, Swing Arm	3.7kg

Laptop Holder - Non-Removable, Swing Arm

Features

- Three section swing arm offering height, rotation & angle adjustment
- Compatible with the PT range of single & double door pharmacy trolleys
- Laptop holder fitted to an upright bolted to the rear left hand corner of the trolley (upright & holder supplied for customer to fit)
- Adjustable to accept laptops 280-435 x 22mm (w x h)
- Maximum capacity 2.0kg
- Laptop supported in a cradle fitted with a steel mounting bracket that can be fixed using either nylock or wing nuts
- Laptop can be secured using a security clamp (supplied)*
- Design allows easy access to laptop ports

*Not compatible with the Dell laptops using the N17 wedge lock system

Standard Colours

- Paint - Grey

Item	Description	Weight
PT/LHNR/S	Non-Removable, Swing Arm	5.0kg

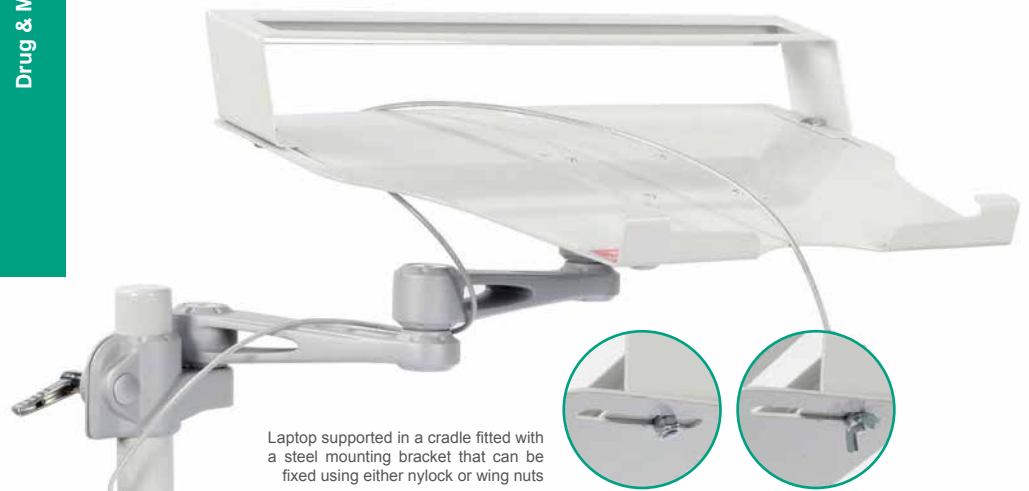

Laptop supported in a cradle fitted with a steel mounting bracket that can be fixed using either nylock or wing nuts



PTD/HSB/BP6/PT/LH/C5

Motion C5 Holder - Swing Arm

Features

- Three section swing arm offering height, rotation & angle adjustment
- Compatible with the PT range of single & double door pharmacy trolleys
- Motion C5 holder fitted to an upright bolted to the rear left hand corner of the trolley (upright & holder supplied for customer to fit)
- Maximum capacity 2.0kg
- Tablet located in a RAM-In-Motion passive dock allowing for easy insertion & removal

Standard Colours

- Paint - Grey



Item	Description	Weight
PT/LH/C5	Swing Arm	2.7kg

Fitting Your Security Clamp

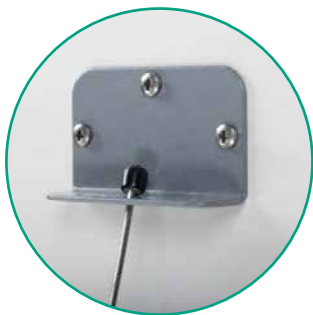

Securely fasten one end of the clamp to the wall



The 'hook shaped' end is trapped by the door when closed & locked

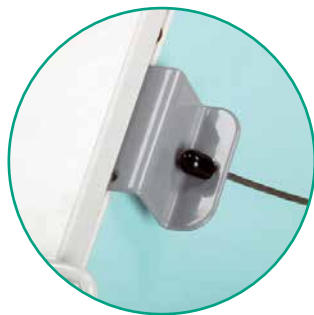

Security Clamp

Features

- Allows the trolley to be secured to the 'fabric of the building'
- Requires no additional keys, utilises the trolleys own locking system
- One end is secured to the wall, the 'hook shaped' end is trapped by the door/lid of the trolley when closed & locked
- Recommended wall fitting height approx 1000mm



Important Note - Security Clamps
 It is a requirement that when the trolley is not in use it should be secured to the 'fabric of the building'. Not only does this prevent casual theft, i.e. trolleys being pushed to an isolated area & broken into, but also encourages good nursing practice, giving the trolley a "permanent home".
 "Safe & Secure Handling of Medicines - Royal Pharmaceutical Society, GB-March 2005"

Item	Description	Cable Length	Weight
MT/1/6F	Security Clamp	950mm	0.75kg

Distribution Trolleys - Lockable Drawers

Features

- Trolleys suitable for the distribution of drugs & medicines from pharmacy to the ward & also with self-administration/patient own drug schemes
- Provides secure drug delivery using drawers which when locked are securely fastened to the trolley
- Boxes are fitted with a CAM lock, supplied with two keys
- Supplied as standard with locks to differ, allowing each ward to have its own key & be responsible for removing the drawer from the trolley
- The remaining key should be kept at the pharmacy
- Max capacity per drawer 3kg
- Master keys are available (additional cost)
- Upper work surface
- Push handles
- Document pocket fitted to one end of the trolley
- Low level corner bumpers to protect the fabric of the building
- 125mm swivel castors, 2 off braking

Dimensions (w x d x h)

- SA005 - 1026 x 523 x 1002mm
- SA025 - 1180 x 523 x 1002mm
- Drawer - 145 x 423 x 230mm (Internal)

Standard Colours

- Paint - Grey
- Work Surface - Spearmint

Options

- Master Keys



SA005

Item	Description	Weight
SA005	Distribution Trolley - 15 Drawers	49.0kg
SA025	Distribution Trolley - 18 Drawers	56.0kg



Drug & Medicine Storage

Drug & Medicine Cabinets	132
Controlled Drug Cabinets	137
CLIQ®	140
Drug & Medicine Cupboards	142
Options	144
Patients/Residents Own Medication Cabinets	146
Tablet Counter & Storage Boxes	150
Pharmacy & Vaccine Refrigerators	151



Drug & Medicine Cabinets - Shelves & Door Shelves

Features

- Independently tested to BS 2881: 1989 (Security Level One) Specification for Cupboards for the Storage of Medicines in Health Care Premises
- BS 3621 anti-pick & drill, key retaining five pin cylinder lock (supplied with 3 keys)
- Adjustable & removable shelves (190mm deep) & door shelves (75mm deep)
- Key profile unique to Hospital Metalcraft Ltd, offering 250,000 differs
- Compatible with CLIQ®, integrating electronics into high security mechanical disc cylinders & keys, combining electronic security & remote management in real time
- Optional Digital Push Button Lock (does not conform to BS 2881: 1989)
- 12v DC LED lighting/warning system (model dependent) with volt-free contact to allow connection to light/nurse call systems. Requires 100v - 240v ~, 50Hz -60Hz, 0.3A Mains supply. Supplied fitted with a UK 3 pin plug. CE marked & conforms to the low voltage directives 73/23/EEC & 89/336/EC
- Lighting transformer housing adds 105mm to the overall height
- 0.9mm (20 gauge) mild steel welded construction
- Mounting holes provided in back (fixings not included)
- Modular design allows for easy interchange with HTM 63 storage systems
- Compatible with our range of CD cabinets for the storage of Controlled Drugs (see page 138)

Standard Colours

- Paint - White

Options

- DGL - Digital Push Button Lock
- SL - Suited Locks (contact us for more information)
- PC/500/ST - Sloping Top (500mm Wide Cabinets)
- PC/600/ST - Sloping Top (600mm Wide Cabinets)
- PC/800/ST - Sloping Top (800mm Wide Cabinets)
- PC/1000/ST - Sloping Top (1000mm Wide Cabinets)
- PC/RLBS - Remote Light Box (Surface Mounted)
- PC/RLBF - Remote Light Plate (Flush Mounted)
- PCB - Buzzer Alarm (Factory Fit To Cabinets With Lights Only)



Lighting Transformer Housing Adds 105mm to Overall Height

Single Door Cabinets

Right Hand Opening		Left Hand Opening		Shelves/Door Shelves	Overall Dimensions (w x d x h)	Compatible CD Cabinets	Weight
With Light*	Without Light	With Light*	Without Light				
PC536	PC536/LX	PC536/LH	PC536/LH/LX	3 Shelves / 3 Door Shelves	500 x 300 x 600mm	CD005, CD010	29.9kg
PC539	PC539/LX	PC539/LH	PC539/LH/LX	4 Shelves / 4 Door Shelves	500 x 300 x 900mm	CD005, CD010, CD015	34.0kg
PC636	PC636/LX	PC636/LH	PC636/LH/LX	3 Shelves / 3 Door Shelves	600 x 300 x 600mm	CD005, CD010	33.9kg
PC639	PC639/LX	PC639/LH	PC639/LH/LX	4 Shelves / 4 Door Shelves	600 x 300 x 900mm	CD005, CD010, CD015	38.0kg

* Transformer casing adds 105mm to overall height

Double Door Cabinets

Single Lock (Secures Both Doors)		Each Door Fitted With A Lock		Shelves/Door Shelves	Overall Dimensions (w x d x h)	Compatible CD Cabinets	Weight
With Light*	Without Light	With Light*	Without Light				
PC836	PC836/LX	PC836/IND**	PC836/IND/LX**	6 Shelves / 5 Door Shelves	800 x 300 x 600mm	CD005, CD010**	40.9kg
PC839	PC839/LX	PC839/IND***	PC839/IND/LX***	8 Shelves / 8 Door Shelves	800 x 300 x 900mm	CD005, CD010, CD015***	45.9kg
PC1036	PC1036/LX	PC1036/IND	PC1036/IND/LX	6 Shelves / 6 Door Shelves	1000 x 300 x 600mm	CD005, CD010	48.9kg
PC1039	PC1039/LX	PC1039/IND	PC1039/IND/LX	8 Shelves / 8 Door Shelves	1000 x 300 x 900mm	CD005, CD010, CD015	53.9kg

*Transformer casing adds 105mm to overall height
 **CD010 not compatible with PC836/IND & PC836/IND/LX
 ***CD015 not compatible with PC839/IND & PC839/IND/LX



Drug & Medicine Cabinets - Deep Shelves

Features

- Independently tested to BS 2881: 1989 (Security Level One) Specification for Cupboards for the Storage of Medicines in Health Care Premises
- BS 3621 anti-pick & drill, key retaining five pin cylinder lock (supplied with 3 keys)
- Adjustable & removable deep shelves (250mm deep)
- Key profile unique to Hospital Metalcraft Ltd, offering 250,000 differs
- Compatible with CLIQ®, integrating electronics into high security mechanical disc cylinders & keys, combining electronic security & remote management in real time
- Optional Digital Push Button Lock (does not conform to BS 2881: 1989)
- 12v DC LED lighting/warning system (model dependent) with volt-free contact to allow connection to light/nurse call systems. Requires 100v - 240v ~, 50Hz -60Hz, 0.3A Mains supply. Supplied fitted with a UK 3 pin plug. CE marked & conforms to the low voltage directives 73/23/EEC & 89/336/EC
- Lighting transformer housing adds 105mm to the overall height
- 0.9mm (20 gauge) mild steel welded construction
- Mounting holes provided in back (fixings not included)
- Modular design allows for easy interchange with HTM 63 storage systems
- Compatible with our range of CD cabinets for the storage of Controlled Drugs (see page 138)

Standard Colours

- Paint - White

Options

- DGL - Digital Push Button Lock
- SL - Suited Locks (contact us for more information)
- PC/300/ST - Sloping Top (300mm Wide Cabinets)
- PC/500/ST - Sloping Top (500mm Wide Cabinets)
- PC/600/ST - Sloping Top (600mm Wide Cabinets)
- PC/800/ST - Sloping Top (800mm Wide Cabinets)
- PC/1000/ST - Sloping Top (1000mm Wide Cabinets)
- PC/RLBS - Remote Light Box (Surface Mounted)
- PC/RLBF - Remote Light Plate (Flush Mounted)
- PCB - Buzzer Alarm (Factory Fit To Cabinets With Lights Only)

* Transformer casing adds 105mm to overall height

Single Door Cabinets

Right Hand Opening		Left Hand Opening		Shelves	Nomad Cassette Capacity	Overall Dimensions (w x d x h)	Compatible CD Cabinets	Weight
With Light*	Without Light	With Light*	Without Light					
PC336/FS	PC336/FS/LX	PC336/FS/LH	PC336/FS/LH/LX	3	13 Cassettes	300 x 300 x 600mm	CD005	16.9kg
PC536/FS	PC536/FS/LX	PC536/FS/LH	PC536/FS/LH/LX	3	24 Cassettes	500 x 300 x 600mm	CD005, CD010	29.9kg
PC636/FS	PC636/FS/LX	PC636/FS/LH	PC636/FS/LH/LX	3	32 Cassettes	600 x 300 x 600mm	CD005, CD010	33.9kg
PC539/FS	PC539/FS/LX	PC539/FS/LH	PC539/FS/LH/LX	4	35 Cassettes	500 x 300 x 900mm	CD005, CD010, CD015	34.9kg
PC639/FS	PC639/FS/LX	PC639/FS/LH	PC639/FS/LH/LX	4	44 Cassettes	600 x 300 x 900mm	CD005, CD010, CD015	38.9kg



Lighting Transformer Housing Adds 105mm to Overall Height

Double Door Cabinets

Single Lock (Secures Doors)		Each Door Fitted With A Lock		Shelves	Nomad Cassette Capacity	Overall Dimensions (w x d x h)	Compatible CD Cabinets	Weight
With Light*	Without Light	With Light*	Without Light					
PC836/FS	PC836/FS/LX	PC836/FS/IND**	PC836/FS/IND/LX**	6	-	800 x 300 x 600mm	CD005, CD010**	40.9kg
PC839/FS	PC839/FS/LX	PC839/FS/IND***	PC839/FS/IND/LX***	8	-	800 x 300 x 900mm	CD005, CD010, CD015***	45.9kg
PC1036/FS	PC1036/FS/LX	PC1036/FS/IND	PC1036/FS/IND/LX	6	58 Cassettes	1000 x 300 x 600mm	CD005, CD010	48.9kg
PC1039/FS	PC1039/FS/LX	PC1039/FS/IND	PC1039/FS/IND/LX	8	80 Cassettes	1000 x 300 x 900mm	CD005, CD010, CD015	53.9kg

*Transformer casing adds 105mm to overall height
 **CD010 not compatible with PC836/FS/IND & PC836/FS/IND/LX
 *** CD015 not compatible with PC839/FS/IND & PC839/FS/IND/LX



PC1039/MDS
(Frames not included)

PC536/MDS
(Frames not included)

Drug & Medicine Cabinets - Blister Pack (MDS)

Features

- Independently tested to BS 2881: 1989 (Security Level One) Specification for Cupboards for the Storage of Medicines in Health Care Premises
- BS 3621 anti-pick & drill, key retaining five pin cylinder lock (supplied with 3 keys)
- Hooks at rear of cabinet support frames for the popular blister pack Monitored Dosage System (MDS)
- Key profile unique to Hospital Metalcraft Ltd, offering 250,000 differs
- Compatible with CLIQ®, integrating electronics into high security mechanical disc cylinders & keys, combining electronic security & remote management in real time
- Optional Digital Push Button Lock (does not conform to BS 2881: 1989)
- 12v DC LED lighting/warning system (model dependent) with volt-free contact to allow connection to light/nurse call systems. Requires 100v - 240v ~, 50Hz -60Hz, 0.3A Mains supply. Supplied fitted with a UK 3 pin plug. CE marked & conforms to the low voltage directives 73/23/EEC & 89/336/EC
- Lighting transformer housing adds 105mm to the overall height
- 0.9mm (20 gauge) mild steel welded construction
- Mounting holes provided in back (fixings not included)
- Modular design allows for easy interchange with HTM 63 storage systems

Standard Colours

- Paint - White

Options

- DGL - Digital Push Button Lock
- SL - Suited Locks (contact us for more information)
- PC/500/ST - Sloping Top (500mm Wide Cabinets)
- PC/600/ST - Sloping Top (600mm Wide Cabinets)
- PC/1000/ST - Sloping Top (1000mm Wide Cabinets)
- PC/RLBS - Remote Light Box (Surface Mounted)
- PC/RLBF - Remote Light Plate (Flush Mounted)
- PCB - Buzzer Alarm (Factory Fit To Cabinets With Lights Only)

Single Door Cabinets

Right Hand Opening		Left Hand Opening		MDS Frame Capacity	Overall Dimensions (w x d x h)	Weight
With Light*	Without Light	With Light*	Without Light			
PC536/MDS	PC536/MDS/LX	PC536/LH/MDS	PC536/LH/MDS/LX	2 Frames	500 x 300 x 600mm	26.9kg
PC539/MDS	PC539/MDS/LX	PC539/LH/MDS	PC539/LH/MDS/LX	4 Frames	500 x 300 x 900mm	31.4kg
PC639/MDS	PC639/MDS/LX	PC639/LH/MDS	PC639/LH/MDS/LX	6 Frames	600 x 300 x 900mm	35.2kg

Double Door Cabinets

Single Lock (Secures Both Doors)		Each Door Fitted With A Lock		MDS Frame Capacity	Overall Dimensions (w x d x h)	Weight
With Light*	Without Light	With Light*	Without Light			
PC1039/MDS	PC1039/MDS/LX	PC1039/IND/MDS	PC1039/IND/MDS/LX	8 Frames	1000 x 300 x 900mm	26.9kg

* Transformer casing adds 105mm to overall height

Controlled Drug Cabinets - Multi-Point Locking

Features

- Exceeds the statutory requirement for the storage of controlled drugs, "The Misuse of Drugs (Safe Custody) Regulations 1973"
- Independently security tested by Sold Secure attaining "Silver Accreditation" based on a realistic evaluation of the attack resistance of Controlled Drug Cabinets
- BS 3621 anti-pick & drill, key retaining six pin cylinder lock (supplied with 2 keys & identification card)
- Multi-point locking, operated using a handle mounted on the door (independently tested)
- Key profile unique to Hospital Metalcraft Ltd, offering 250,000 differs
- Compatible with CLIQ®, integrating electronics into high security mechanical disc cylinders & keys, combining electronic security & remote management in real time
- Lock protected by hardened steel plates & stainless steel escutcheon
- 3.0mm (10 gauge) mild steel, seamlessly welded construction
- Mounting holes provided in back (fixings not included)
- Fixed shelf

Standard Colours

- Paint - White

Options

- MS910 - 12v DC LED Warning Light System (compatible with MS005 & MS010)
- MS911 - 12v DC LED Warning Light System (compatible with MS015)



MS005



MS010



MS015

Item	Description	Shelves	Lighting / Warning System (Optional)	Overall Dimensions (w x d x h)	Weight
MS005	Small	0	MS910	335 x 265 x 300mm	17.0kg
MS010	Medium	1	MS910	335 x 265 x 550mm	26.0kg
MS015	Large	1	MS911	500 x 325 x 550mm	37.0kg

Controlled Drug Cabinets - Single Point Locking

Features

- Exceeds the statutory requirement for the storage of controlled drugs "The Misuse of Drugs (Safe Custody) Regulations 1973" (with the exception of CD040, CD045, CD140 & CD145)
- BS 3621 anti-pick & drill, key retaining six pin cylinder lock (supplied with 2 keys & identification card)
- Single-point locking
- Key profile unique to Hospital Metalcraft Ltd, offering 250,000 differs per profile
- Compatible with CLIQ®, integrating electronics into high security mechanical disc cylinders & keys, combining electronic security & remote management in real time
- Can be supplied with a micro-switch to allow connection to remote lighting/nurse call system by others (CD905), or supplied with a 12v DC LED lighting/warning system with volt-free contact to allow connection to light/nurse call systems. Requires 100v - 240v ~, 50Hz -60Hz, 0.3A Mains supply. Supplied fitted with a UK 3 pin plug. CE marked & conforms to the low voltage directives 73/23/EEC & 89/336/EC
- Lighting transformer casing adds 105mm to the overall height
- 1.5mm (16 gauge) mild steel, seamless welded construction
- Mounting holes provided in back (fixings not included)
- Adjustable & removable shelves
- Security of models CD005, CD010 & CD015 can be enhanced by concealing inside one of our 'Drug & Medicine Cabinets'
- Modular design allows for easy interchange with HTM 63 storage systems
- Supplied right hand hinging as standard, left hand available on request

Standard Colours

- Paint - White

Options

- CD905 - Micro-switch to connect to remote light box / alarm
- CD910 / CD911 / CD912 / CD913 - 12v DC LED Lighting/ Warning System (for compatibility see tables below)
- PCB - Buzzer Alarm (Factory Fit To Cabinets With Lights Only)

Optional 12v DC LED Lighting/Warning System
Requires 100v - 240v ~, 50Hz-60Hz, 0.3A Mains supply.
Supplied fitted with a UK 3 pin plug

- Door activated micro-switch
- LED* warning light illuminates
- Green when closed
- Red when open
- Flashes red when open for 2 ½ minutes
- Volt-free contact to allow connection to an additional light/nurse call system
- Optional buzzer

*Externally mounted



CD010/CD910



CD015



CD010



CD125

R/H Door	L/H Door	Shelves	Lighting / Warning System (Optional)	Overall Dimensions (w x d x h)	Weight
CD005	-	1	CD910	210 x 270 x 300mm	8.0kg
CD010	CD110	1	CD910	335 x 270 x 300mm	9.0kg
CD015	CD115	2	CD910	335 x 270 x 550mm	17.0kg
CD020	CD120	2	CD910	500 x 300 x 550mm	20.0kg
CD025	CD125	3	CD910	500 x 300 x 850mm	37.0kg



CD035



CD135



CD040

R/H Door	L/H Door	Shelves	Lighting / Warning System (Optional)	Overall Dimensions (w x d x h)	Weight
CD030	CD130	3	CD911	500 x 450 x 850mm	42.0kg
CD035	CD135	4	CD911	500 x 450 x 1250mm	59.0kg
CD040	CD140	6	CD912	500 x 315 x 1900mm	73.0kg
CD045	CD145	6	CD913	500 x 465 x 1900mm	91.0kg



CD145

Auditable Access Control for Medicines Management



What is CLIQ®?

CLIQ® is the very latest in user-friendly, web-based security management. Part of the Protec² CLIQ® from Abloy range, CLIQ® is designed for remote sites, enabling the commissioning, programming and full administration of security management centrally via web-based software.

How Does It Work?

CLIQ® integrates electronics into mechanical cylinders and keys, providing a security solution that can be managed remotely. In short, this works like an electronic handshake: when the key is inserted it engages with the cylinder, sending a random number back to the key. The key replies with an encrypted response which is decrypted by the cylinder and if valid the cylinder then allows access. It is important to remember that the mechanical combination must match as well as the digital combination. CLIQ® allows a single key to be used with multiple cabinets or trolleys. be used with multiple cabinets or trolleys.

System Features

- Secure - Provides dual security through the patented Protec² CLIQ® from Abloy mechanical disc cylinders and keys along with DES encryption, a recognised electronic standard
- Easily Programmable - Keys can be added quickly and programmed to specific time and date schedules
- Fully Auditable - Audit trails can be accessed from both the cylinder and key
- Reduces Keys - One key can be programmed to open multiple cabinets or trolleys
- The CLIQ® environment works in an Amazon cloud hosted server
- maintained and supported by Abloy allowing remote user access via a secure connection from anywhere in the world
- Cost Effective - Low installation & maintenance costs along with a long lifecycle (requires no wires or system updates, power for the cylinder is provided by the key)
- Easily Retrofittable - CLIQ® can be used with a variety of locking solutions including euro lock profile cases, padlocks, camlocks & furniture locks

System Benefits

- Save valuable nursing time which can be used to deliver patient care
- Reduces delay in administering medication
- Improves drug & medicine security
- No more unlocked drug & medicine cabinets
- Eliminates the need to replace locks as a result of lost keys
- One key can be programmed to open multiple cabinets or trolleys
- The key is made personal to that member of staff, resulting in increased ownership and a reduction in the number of keys lost
- Easy to apply remote management, saves money and has the ability to cover several hospitals
- Time and date based access rights, with a full audit trail allow for full visibility of when visits were made
- New keys can be added to the system quickly and easily, removal of lost ones is hassle-free
- Reduction in time spent looking for the person holding the key

Process Flow



Start of Shift

Key Validation & Authorisation

Recurring validation forces users to place their key into the Wall PD. User authorisations are uploaded to the key

During The Shift

Operation

The key will only open cabinets where access permissions have been granted. Each time the key is used in a cabinet fitted with an PROTEC² cylinder an audit trail is created on both the key and cylinder



End of Shift

Automated Data Transfer

Key is placed into the Wall PD. Previous key transactions are automatically downloaded from the key and stored in the audit trail archive



System Components



CLIQ® Key

- Provides dual security through the patented PROTEC² mechanical disc cylinders and keys along with DES encryption, a recognised electronic standard
- Thin, light but incredibly strong key

PROTEC² Lock Barrel

- A bump proof mechanism
- Exceptionally smooth key entry and operation
- Can be master keyed and keyed alike with cylinders, cam and furniture locks as well as padlocks



Wall Programming Device

- Updates keys remotely (linking the server and users keys)
- Offers high level data encryption
- Allows the use of recurring validation, forcing users to validate their keys at the start of their shift whilst automatically downloading audit trails which are relayed to the server

Traka21

- Sophisticated stand-alone key management system to control the issuing of keys
- Keys are accessed using PIN number technology
- Holds up to 21 keys or keysets



Questions & Answers

Answers to common questions about CLIQ®

Q How secure is it?

A CLIQ® uses a DES encryption (Data Encryption Standard) so it is just as safe as online banking

Q Can I use this with an existing Abloy master key system?

A Yes; CLIQ® can be integrated with an existing PROTEC² master key system

Q What is the benefit?

A CLIQ® will give you some of the benefits of access control, such as adding, deleting and amending access rights, take audit trails from keys and cylinders as well as setting the key to expire on a specific date at a specific time. Also, lost or stolen key can be easily be deleted electronically

Q Is the system expensive to install?

A The system has a low installation & maintenance cost along with a long life cycle. CLIQ® cylinders are designed to fit into Euro Profile mechanical lock cases. No wiring is required to the cabinet. The wall programming device requires an Ethernet connection and power through a 12-24V adapter or alternatively power over Ethernet

Q Who maintains the system?

A System maintenance is normally assigned to a member of the hospital staff who will be responsible for programming/issuing of keys along with interrogation of audit trails

Q How many audit trails can be collected from a single key?

A The programmable user key stores the last 1,800 transactions and the last 20 foreign transactions

Q How large is the cylinder memory?

A 200 key groups; each key group holding 65,000 individual unique key combinations. This provides up to 13 million unique possible key combinations in one cylinder and can retain a black list of 3,000 keys

Q Can I take an audit trail from a cylinder?

A Yes, the cylinder stores an audit trail of the last 1,000 key insertions

Q What happens if a key is lost?

A We recommend that time schedules are set to each key, so if the key is not returned it will expire. Keys can be removed from the cylinder with the programming key or directly from the system. If subsequently found keys can be added back and re-issued. In the event that an audit trail is required for a lost key, lock cylinders can be interrogated using a programming key (each cylinder stores an audit trail of the last 1,000 key insertions)

Q How long do the batteries last?

A The battery is located in the key, not the cylinder. Under normal usage a battery will operate up to 20,000 cycles or 2 years

Q How is the information sent?

A Via the internet to a wall mounted PD

Q Can the information be taken off the Wall mounted PD by anyone?

A No, there is no information stored on the PD, it is stored on a server until the correct key is inserted and only then is the information securely transferred

Q Is it possible to access the system remotely?

A The CLIQ® environment works in an Amazon cloud hosted server environment ISO27001 Accredited, maintained and supported by Abloy allowing remote user access via a secure connection from anywhere in the world.

Q Where is the server?

A Amazon - Republic Of Ireland

Q Can I host this myself?

A Yes, but there would be additional costs

Q What if there is no internet connection on a particular site?

A A mobile PD is available which will work on the GSM network

Q How can I better control the issuing of keys?

A Through the use of Traka21 (key safe) keys can be automatically assigned to specific users. Keys are issued using either the staff members own security card or via pin number technology.

Q Is it possible to integrate the CLIQ® key with other systems?

A Unique RFID tag identifiers can be inserted into the key allowing it to be used with other MIFARE card based RFID systems

- Self-Administration Schemes
- Medicines Management
- Patient Records



MC/L/870/FS

MC/R/870/3S2D

Drug & Medicine Cupboards - Single Door

Features

- Independently tested to BS2881: 1989 (Security Level One) Specification for Cupboards for the Storage of Medicines in Health Care Premises
- BS3621 anti-pick & drill, key retaining five pin cylinder lock (supplied with 3 keys)
- Single door cupboards available as either 870 / 1870mm high
- Available with either...
 - Plastic Trays
 - Shelves
 - Shelves & Dividers
- Key profile unique to Hospital Metalcraft Ltd, offering 250,000 differs
- Compatible with CLIQ®, integrating electronics into high security mechanical disc cylinders & keys, combining electronic security & remote management in real time
- Optional Digital Push Button Lock (does not conform to BS 2881: 1989)
- Worksurface supplied with 870mm cupboards (removable to assist with positioning under existing worktops)
- 0.9mm (20 Gauge) mild steel welded construction
- Modular design allows for easy interchange with HTM 63 storage systems

Dimensions (w x d x h)

- Overall Dimensions
 - 870mm - 500 x 536 x 870mm
 - 1870mm - 500 x 536 x 1870mm
- Trays
 - Shallow Tray - 355 x 405 x 100mm (internal)
 - Deep Tray - 355 x 405 x 150mm (internal)

Standard Colours

- Paint - White

Options

- SL - Suited Locks (contact us for more information)
- DGL - Digital Push Button Lock
- MC/JK/870 - Joining Kit & Full Width Worktop (required when connecting 870mm cupboards)
- MC/JK/1870 - Joining Kit (required when connecting 1870mm cupboards)
- MC/ST - Sloping Top (1870mm cupboards)
- MC/DIV - Set of 16 Dividers

R/H Hinged	L/H Hinged	Description	Weight
MC/R/870/3S2D	MC/L/870/3S2D	Single Door, Five Pin Cylinder Lock, 870mm High, Plastic Trays	45.6kg
MC/R/870/FS	MC/L/870/FS	Single Door, Five Pin Cylinder Lock, 870mm High, Flat Shelves	37.0kg



MC/R/1870/FS/DGL



MC/R/1870/7S5D



Plastic Trays

- Interchangeable with our popular CT range (post 2016)
 - 870mm Cupboards - 3 x 100mm, 2 x 150mm trays
 - 1870mm Cupboards - 7 x 100mm, 5 x 150mm trays
- Translucent high impact plastic trays feature an integral handle with plastic clip on label cover, (max load per tray 5kg)
- Each cupboard is supplied with perforated coloured label strips (white, blue, green, yellow & red)
- Trays can be subdivided in both length & width using simple slot in dividers (each tray supplied with 2 x long & 2 x short dividers)

Shelves

- Flat shelves adjustable at 50mm increments
 - 870mm Cupboards - 3 x shelves
 - 1870mm Cupboards - 8 x shelves
- Suitable for the storage of MDS frames (if required)
 - 870mm Cupboards - 6 x frames
 - 1870mm Cupboards - 16 x frames

Shelves & Dividers

- Flat shelves adjustable at 50mm increments
- Removable dividers 100mm high adjustable at 25mm increments
 - 870mm Cupboards - N/A
 - 1870mm Cupboards - 8 x shelves & 16 x dividers

R/H Hinged	L/H Hinged	Description	Weight
MC/R/1870/7S5D	MC/L/1870/7S5D	Single Door, Five Pin Cylinder Lock, 1870mm High, Plastic Trays	88.6kg
MC/R/1870/FS	MC/L/1870/FS	Single Door, Five Pin Cylinder Lock, 1870mm High, Flat Shelves	69.0kg
MC/R/1870/FSD	MC/L/1870/FSD	Single Door, Five Pin Cylinder Lock, 1870mm High, Flat Shelves & Dividers	79.0kg

Sloping Top

Features

- Compatible with 300/500/600/800 & 1000mm wide PC cabinets & 500mm wide MC cupboards
- Prevents items being stored on the top of the cabinet & assists cleaning
- Increases the overall height of the cabinet by 193mm
- Void within the top provides a space to locate the transformer for the lighting/warning system
- Access to the transformer provided via a removable plate

Standard Colours

- Paint - White

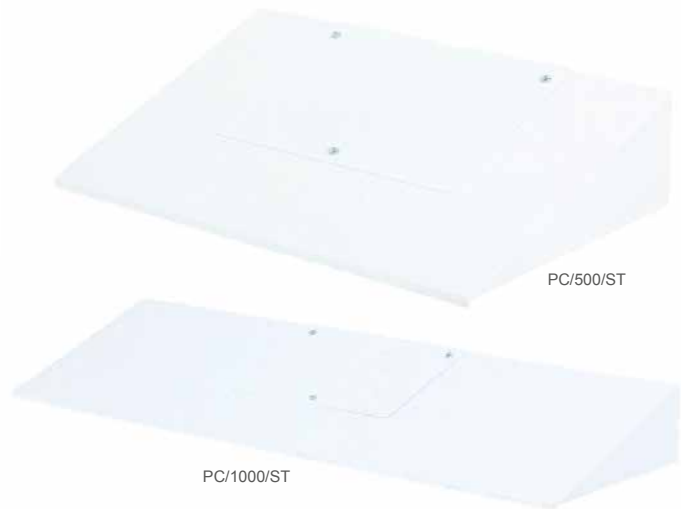

Item	Description	Weight
PC/300/ST	300mm Wide PC Cabinets	1.3kg
PC/500/ST	500mm Wide PC Cabinets	1.5kg
PC/600/ST	600mm Wide PC Cabinets	1.6kg
PC/800/ST	800mm Wide PC Cabinets	1.7kg
PC/1000/ST	1000mm Wide PC Cabinets	1.8kg
MC/ST	500mm Wide MC Cupboards	2.9kg

Warning Light System

Features

- Suitable for use with Bristol Maid MS & CD Controlled Drug cabinets
- Provides a visual indication when the cabinet is open
- LED illuminates...
 - Green when the door is closed
 - Red when the door is open
 - Flashes red when open for 2 ½ minutes
- Operates using a door activated micro-switch connected to a 12v DC LED lighting/warning system (model dependent) with volt-free contact to allow connection to light/nurse call systems. Requires 100v - 240v ~, 50Hz -60Hz, 0.3A Mains supply. Supplied fitted with a UK 3 pin plug. CE marked & conforms to the low voltage directives 73/23/EEC & 89/336/EC
- Lighting transformer housing adds 105mm to the overall height



Item	Description
MS Range Compatible	
MS910	12v DC LED Lighting/Warning System - Compatible with MS005 & MS010
MS911	12v DC LED Lighting/Warning System - Compatible with MS015
CD Range Compatible	
CD910	12v DC LED Lighting/Warning System - Refer To Page 138 For Compatibility
CD911	12v DC LED Lighting/Warning System - Refer To Page 139 For Compatibility
CD912	12v DC LED Lighting/Warning System - Refer To Page 139 For Compatibility
CD913	12v DC LED Lighting/Warning System - Refer To Page 139 For Compatibility

Joining Kits - MC Range of Cabinets

Features

- Allows two units to be joined together
- 870mm joining kit supplied with a full width worktop (2 units)



Item	Description	Compatibility
MC/JK/870	Joining Kit & Full Width Worktop	870mm High Units
MC/JK/1870	Joining Kit	1870mm High Units

Remote Light Box

Features

- Connects to all Bristol Maid PC, MS & CD cabinets fitted with a light)
- Provides a remote visual indication when the cabinet is open
- Models available for surface or flush mounting
- Units fitted without a light require a separate micro-switch & a 12v DC supply



Item	Description	Overall Dimensions
PC/RLBS	Remote Light Box - Surface Mounted	100 x 50 x 150mm
PC/RLBF	Remote Light Plate - Flush Mounted	100 x 50 x 150mm

Digital Push Button Lock

Features

- Requires a five digit code to operate (set by customer)
- Cabinets fitted with this lock will not conform to BS2881: 1989 (Security Level One) Specification for Cupboards for the Storage of Medicines in Health Care Premises



Item	Description
DGL	Digital Push Button Lock

Dividers - MC Range of Cabinets

Features

- Spare / replacement dividers for MC cupboards supplied with flat shelves & dividers
- Removable 100mm high dividers locate into slots on the shelves (adjustable at 25mm increments)
- Compatible with 870mm & 1870mm high units



Item	Description
MC/DIV	Set of 16 Dividers

Micro Switch

Features

- Micro-switch to allow connection to remote lighting/nurse call system by others



Item	Description
MS905	Micro-switch (MS Range Compatible)
CD905	Micro-switch (CD Range Compatible)
PC905	Micro-switch (PC Range Compatible)

Buzzer Alarm

Features

- Replacement circuit board with buzzer
- Compatible for PC, MS & CD cabinets fitted with a light unit
- Buzzer pulses on/off after the door has been open for 2 ½ minutes
- Factory fit only to cabinets fitted with lights

Item	Description
PCB	Buzzer Alarm

Suited Locks

Features

- Suited locks (allows multiple locks / cabinets to operate using the same key)
- Not all cabinets can have suited locks - contact customer service

Item	Description
SL	Suited Locks

Patients / Residents Own Medication Cabinets - Self Administration



SAC/213/S



SAC/313/S/VP

Features

- Suitable for use with...
 - Drugs retained in original packs
 - Individual MDS packs with dividers & name cards
 - Nomad cassettes
 - Roll type blister packs
- Available as side or bottom hinged fitted with either a CAM or electronic push button lock
 - CAM - Supplied with two keys & uses 40 different master suites (for security we recommend that each ward/wing operates a different series, master keys available at additional cost)
 - Electronic Push Button - Battery operated
- Available with a solid door or with an inset perspex visibility panel
- 0.9mm (20 gauge) mild steel, spot welded construction
- Mounting holes in back/bottom (fixings not included)
- Range of mounting plates (optional)
- Shelves not included (optional)
- Supplied with a self-adhesive name card holder (length 60mm)

Electronic Push Button Lock

- Uses a 10 button keypad and a # button. The # button is hidden beneath the handle when in the locked position
- Easy programming & code change
- Four operating codes with differing levels of authority
 - Master code
 - Sub-master code
 - User code
 - Technician code
- User codes are 4 digits
- Master & sub-master codes are 8 digits
- 15,000 openings on 2 x AAA cells (supplied)
- Low battery warning with failure override using 9v battery across LED's (+/-) & master code



Options

- SAC/FS/2 - Shelf, 200mm Wide
- SAC/FS/3 - Shelf, 300mm Wide
- SAC/FS/4 - Shelf, 400mm Wide
- SAC/WP - Mounting Plate, Wall
- SAC/LT - Mounting Plate, Locker Top

Side Hinged

CAM Lock		Electric Push Button Lock		Overall Dimensions (w x d x h)	Shelf Compatibility	Weight
Solid Door	Perspex Visibility Panel	Solid Door	Perspex Visibility Panel			
SAC/213/S	SAC/213/S/VP	SAC/213/S/CL	SAC/213/S/CL/VP	210 x 155 x 315mm	SAC/FS/2	2.6kg
SAC/313/S	SAC/313/S/VP	SAC/313/S/CL	SAC/313/S/CL/VP	310 x 155 x 315mm	SAC/FS/3	3.4kg
SAC/413/S	SAC/413/S/VP	SAC/413/S/CL	SAC/413/S/CL/VP	410 x 155 x 315mm	SAC/FS/4	4.1kg



SAC/213/B



SAC/313/B/CL



SAC/413/B - Shown with optional shelf



SAC/213/B/VP

Bottom Hinged

CAM Lock		Electric Push Button Lock		Overall Dimensions (w x d x h)	Shelf Compatibility	Weight
Solid Door	Perspex Visibility Panel	Solid Door	Perspex Visibility Panel			
SAC/213/B	SAC/213/B/VP	SAC/213/B/CL	SAC/213/B/CL/VP	210 x 155 x 315mm	SAC/FS/2	2.6kg
SAC/313/B	SAC/313/B/VP	SAC/313/B/CL	SAC/313/B/CL/VP	310 x 155 x 315mm	SAC/FS/3	3.4kg
SAC/413/B	SAC/413/B/VP	SAC/413/B/CL	SAC/413/B/CL/VP	410 x 155 x 315mm	SAC/FS/4	4.1kg

Shelves

Features

- Flat shelves (100mm deep)
- Removable to assist cleaning, allow the storage of larger items

Standard Colours

- Paint - White



Item	Description	Weight
SAC/FS/2	Shelf - 200mm Wide Cabinets (SAC/213 Range)	0.2kg
SAC/FS/3	Shelf - 300mm Wide Cabinets (SAC/313 Range)	0.2kg
SAC/FS/4	Shelf - 400mm Wide Cabinets (SAC/413 Range)	0.3kg

Mounting Plates

Features

- Compatible with all SAC cabinets using existing holes (fixings not provided)
- SAC/WP - Cabinet secured to wall plate using a small thumbscrew. Allows the cabinet to be repositioned
- SAC/LT - Mounts to upper surface of traditional bedside cabinets

Standard Colours

- Paint - White



Item	Description	Overall Dimensions (w x d x h)	Weight
SAC/WP	Wall	190 x 12 x 162mm	0.5kg
SAC/LT	Locker Top	190 x 150 x 150mm	0.9kg

Patients / Residents Own Medication Cabinets - Monitored Dosage, MDS Frames

Features

- Suitable for the storage of MDS frames with dividers & name cards (max 100mm depth)
- Models available to hold one or two frames (not included)
 - Small - One frame
 - Large - Two frames
- Available with either a CAM or electronic push button lock
 - CAM - Supplied with two keys, master keys available at additional cost
 - Electronic Push Button - Battery operated
- Mounting holes provided in back (fixings not included)
- Supplied with an adjustable shelf (SA045 & SA045/CL only)
- Constructed from melamine faced chipboard offering an extremely strong & durable, yet aesthetically pleasing appearance
- MDS frames not supplied

Standard Colours

- Body/Door - Beech Woodgrain

Electronic Push Button Lock

- Uses a 10 button keypad and a # button. The # button is hidden beneath the handle when in the locked position
- Easy programming & code change
- Four operating codes with differing levels of authority
 - Master code
 - Sub-master code
 - User code
 - Technician code
- User codes are 4 digits
- Master & sub-master codes are 8 digits
- 15,000 openings on 2 x AAA cells (supplied)
- Low battery warning with failure override using 9v battery across LED's (+/-) & master code



CAM Lock	Electronic Push Button Lock	Capacity	Overall Dimensions (w x d x h)	Weight
SA040	SA040/CL	1 x Frame	325 x 245 x 420mm	7.5kg
SA045	SA045/CL	2 x Frames	325 x 245 x 775mm	12.1kg

Tablet Counter

Features

- Triangular stainless steel tablet counter
- Etched legend to interpret rows (max 22) into number of tablets



Item	Description	Dimensions (w x d x h)
PE/30	Tablet Counter	205 x 195 x 10mm

Storage Boxes - Lightweight

Features

- Lightweight aluminium riveted construction
- Fitted with handle
- Single-point locking using a CAM lock (supplied with 2 keys)
- Cannot be wall mounted

Standard Colours

- Paint - White



Item	Description	Overall Dimensions (w x d x h)	Weight
SB/221	Small	200 x 200 x 150mm	0.9kg
SB/321	Medium	300 x 200 x 150mm	1.1kg
SB/421	Large	400 x 200 x 150mm	1.4kg

Pharmacy & Vaccine Refrigerators - IntelliCold™, Solid & Glass Doors

Features

- Compliant with the Department of Health Green Book
- Recommendations in the General Pharmaceutical Council Standards
- Royal College of Veterinary Surgeons Guidelines
- Designed specifically for the safe storage of vaccines and pharmaceuticals
- Available as bench top, under bench, wall fitting or free-standing
- Temperature range +2°C to +8°C
- Second wandering temperature probe (can be placed anywhere within the refrigerator, ideal for pharmacists needing to comply with MHRA regulations)
- IntelliCold® touch screen controller
 - Automatic 24/7 temperature & fridge operation data recording (micro SD card required)
 - Min/max temperature control, display & recording
 - Displays temperature from both probes
 - High/low temperature alarm
 - Door open alarm
 - Mains failure alarm (requires batteries)
 - Alarm battery back-up
- Internal LED light
- Access port & remote alarm contacts
- Fan assisted cooling
- Off cycle auto defrost
- Low GWP environmentally friendly refrigerant
- Self-closing doors with door open alarm
 - CAM - Supplied with two keys
 - Digital Push Button - Mains operated (uses a 4-digit pin)
- Adjustable shelves
- Micro SD card (optional)
- UKAS traceable calibration service (optional)
- Repeat alarm (optional)

Standard Colours

- Exterior - White/Blue
- Interior - White



CAM Lock	Digital Push Button	Description	Shelves	Overall Dimensions (w x d x h)	Capacity (Litres)	Weight
Solid Door						
5RLDF0119	5RLDF0119DIGILOCK	Bench/Wall Mounting*	2	450 x 510 x 538mm	36 Litres	30.0kg
5RLDF0219	5RLDF0219DIGILOCK	Bench/Wall Mounting*	3	450 x 510 x 740mm	66 Litres	34.0kg
5RLDF0519	5RLDF0519DIGILOCK	Under Bench	3	600 x 600 x 835mm	150 Litres	51.0kg
Glass Door						
5RLDG0519	5RLDG0519DIGILOCK	Under Bench	3	600 x 600 x 835mm	150 Litres	54.0kg

*Integral Wall Mounting Brackets





Examination Treatment Couches & Chairs

Examination & Treatment Couches	154
Leg & Arm Rests	162
Couch Steps	163
Bariatric Examination & Treatment Couches	164
Therapy Couches	170
Examination & Treatment Chairs	174
Bariatric Examination & Treatment Chairs	176
Phlebotomy Chairs	178
Options	181

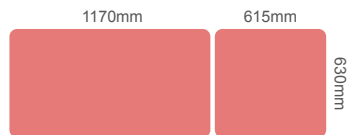

Hand Switch



Foot Switch

Examination & Treatment Couch Two Section

Features

- BS 2838-2: 1991 Examination & general treatment couches, build, performance & safety specifications
- EN 60601-1:2006+A12:2014 Medical electrical equipment. General requirements for basic safety & essential performance

- Electric or hydraulic height adjustment
- Height adjustment from 490-950mm
- Adjustable angle backrest
 - Manual -25 to +90 degrees
 - Electric -22 to +90 degrees
- Anti-trap gas strut fitted with a release lever used on the backrest section (optional electric)
- Retractable castors fitted to both ends to assist with movement & positioning
- One adjustable foot fitted to allow levelling on uneven floors
- Clearance beneath frame allows access for mobile hoists
- Electric models (230V ~, 50/60H) fitted with a UK 3 pin plug & available with a hand or foot switch
- Hydraulic models use a foot pump pedal positioned on both sides of the couch
- Seamless upholstery using flame retardant anti-microbial vinyl
- Frames prepared to accept optional accessories
- Maximum capacity 225kg

Dimensions (w x d x h)

- 630 x 1790 x 490-950mm

Standard Colours

- Paint - White
- Vinyl - Bristol Blue

Options

- E02 - Paper Roll Holder
- E03 - Side Support Rails (Pair)
- E04 - Side Support Rails C/W Cushions (Pair)
- E05 - Breather Hole & Plug
- E06 - Battery Back Up
- E07 - Height Adjustable Armrests (Pair)
- E08 - Infusion Pole
- E11 - Lithotomy Stirrups (Pair)
- E12 - Leg Supports (Pair)

Item	Description	Weight
EC1205/VBB	Hydraulic	68.8kg
EC1210/VBB	Electric, Hand Switch	68.8kg
EC1215/VBB	Electric, Foot Switch	68.8kg
EC1220/VBB	Electric with Electric Backrest - Hand Switch	71.1kg
EC1225/VBB	Electric with Electric Backrest - Foot Switch	71.1kg

Alternative colours available at extra cost. Change suffix 'VBB' on the product code with any of the following i.e. Hydraulic in Aquamarine - EC1205/VAQ

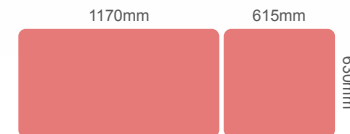
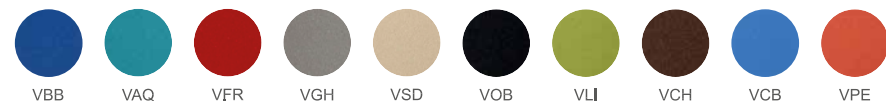

Hand Switch



Foot Switch

Examination & Treatment Couch Two Section, Mobile

Features

- BS 2838-2: 1991 Examination & general treatment couches, build, performance & safety specifications
- EN 60601-1:2006+A12:2014 Medical electrical equipment. General requirements for basic safety & essential performance

- Electric or hydraulic height adjustment
- Height adjustment from 490-950mm
- Adjustable angle backrest
 - Manual -25 to +90 degrees
 - Electric -22 to +90 degrees
- Anti-trap gas strut fitted with a release lever used on the backrest section (optional electric)
- 125mm swivel castors featuring a central locking & steering facility
- Clearance beneath frame allows access for mobile hoists
- Electric models (230V ~, 50/60H) fitted with a UK 3 pin plug & available with a hand or foot switch
- Hydraulic models use a foot pump pedal positioned on both sides of the couch
- Seamless upholstery using flame retardant anti-microbial vinyl
- Swing down side support rails fitted to either side
- Frames prepared to accept optional accessories
- Maximum capacity 225kg

Dimensions (w x d x h)

- 630 x 1790 x 490-950mm

Standard Colours

- Paint - White
- Vinyl - Bristol Blue

Options

- E02 - Paper Roll Holder
- E04/U - Side Support Rails C/W Cushions Upgrade (Pair)
- E05 - Breather Hole & Plug
- E06 - Battery Back Up
- E11 - Lithotomy Stirrups (Pair)
- E12 - Leg Supports (Pair)

Item	Description	Weight
EC1230/VBB	Hydraulic	75.0kg
EC1235/VBB	Electric, Hand Switch	75.0kg
EC1240/VBB	Electric, Foot Switch	75.0kg
EC1245/VBB	Electric with Electric Backrest - Hand Switch	77.3kg
EC1250/VBB	Electric with Electric Backrest - Foot Switch	77.3kg

Alternative colours available at extra cost. Change suffix 'VBB' on the product code with any of the following i.e. Electric, Hand Switch in Graphite - EC1235/VGH

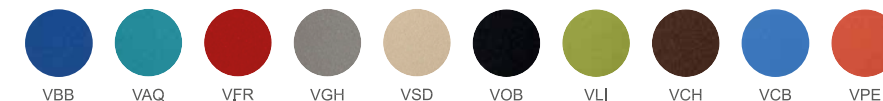



EC1310/VBB

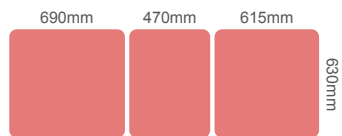

Hand Switch



Foot Switch

Examination & Treatment Couch Three Section

Features

- BS 2838-2: 1991 Examination & general treatment couches, build, performance & safety specifications
- EN 60601-1:2006+A12:2014 Medical electrical equipment. General requirements for basic safety & essential performance
- Electric or hydraulic height adjustment
- Height adjustment from 490-950mm
- Adjustable angle backrest
 - Manual -25 to +90 degrees
 - Electric -22 to +90 degrees
- Adjustable angle footrest from -25 to +75 degrees
- Anti-trap gas struts fitted with release levers used on the back & footrest sections (optional electric backrest)
- Retractable castors fitted to both ends to assist with movement & positioning
- One adjustable foot fitted to allow levelling on uneven floors
- Clearance beneath frame allows access for mobile hoists
- Electric models (230V ~, 50/60H) fitted with a UK 3 pin plug & available with a hand or foot switch
- Hydraulic models use a foot pump pedal positioned on both sides of the couch
- Seamless upholstery using flame retardant anti-microbial vinyl
- Frames prepared to accept optional accessories
- Maximum capacity 225kg

Dimensions (w x d x h)

- 630 x 1790 x 490-950mm

Standard Colours

- Paint - White
- Vinyl - Bristol Blue

Options

- E02 - Paper Roll Holder
- E03 - Side Support Rails (Pair)
- E04 - Side Support Rails C/W Cushions (Pair)
- E05 - Breather Hole & Plug
- E06 - Battery Back Up
- E07 - Height Adjustable Armrests (Pair)
- E08 - Infusion Pole



Item	Description	Weight
EC1305/VBB	Hydraulic	70.2kg
EC1310/VBB	Electric, Hand Switch	70.2kg
EC1315/VBB	Electric, Foot Switch	70.2kg
EC1320/VBB	Electric with Electric Backrest - Hand Switch	72.5kg
EC1325/VBB	Electric with Electric Backrest - Foot Switch	72.5kg

Alternative colours available at extra cost. Change suffix 'VBB' on the product code with any of the following i.e. Electric, Foot Switch in Onyx Black - EC1315/VOB

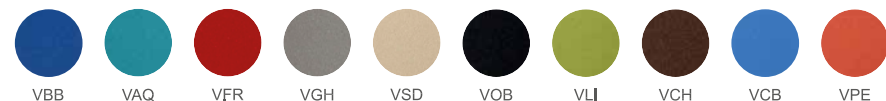

Examination & Treatment Couch Three Section, Mobile

Features

- BS 2838-2: 1991 Examination & general treatment couches, build, performance & safety specifications
- EN 60601-1:2006+A12:2014 Medical electrical equipment. General requirements for basic safety & essential performance
- Electric or hydraulic height adjustment
- Height adjustment from 490-950mm
- Adjustable angle backrest
 - Manual -25 to +90 degrees
 - Electric -22 to +90 degrees
- Adjustable angle footrest from -25 to +75 degrees
- Anti-trap gas struts fitted with release levers used on the back & footrest sections (optional electric backrest)
- 125mm swivel castors featuring a central locking & steering facility
- Clearance beneath frame allows access for mobile hoists
- Electric models (230V ~, 50/60H) fitted with a UK 3 pin plug & available with a hand or foot switch
- Hydraulic models use a foot pump pedal positioned on both sides of the couch
- Seamless & contoured upholstery using flame retardant & anti-microbial vinyl
- Swing down side support rails fitted to either side
- Frames prepared to accept optional accessories
- Maximum capacity 225kg

Dimensions (w x d x h)

- 630 x 1790 x 490-950mm

Standard Colours

- Paint - White
- Vinyl - Bristol Blue

Options

- E02 - Paper Roll Holder
- E04/U - Side Support Rails C/W Cushions Upgrade (Pair)
- E05 - Breather Hole & Plug
- E06 - Battery Back Up

Item	Description	Weight
EC1330/VBB	Hydraulic	76.4kg
EC1335/VBB	Electric, Hand Switch	76.4kg
EC1340/VBB	Electric, Foot Switch	76.4kg
EC1345/VBB	Electric with Electric Backrest - Hand Switch	78.7kg
EC1350/VBB	Electric with Electric Backrest - Foot Switch	78.7kg



EC1335/VBB

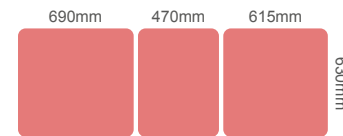

Hand Switch



Foot Switch

Alternative colours available at extra cost. Change suffix 'VBB' on the product code with any of the following i.e. Electric with Electric Backrest - Hand Switch in Coastal Blue - EC1345/VCB

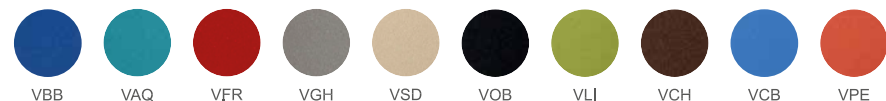

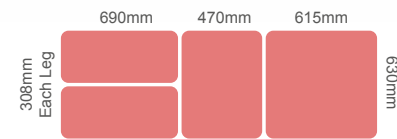

Hand Switch



Foot Switch

Examination & Treatment Couch Four Section

Features

- BS 2838-2: 1991 Examination & general treatment couches, build, performance & safety specifications
- EN 60601-1:2006+A12:2014 Medical electrical equipment. General requirements for basic safety & essential performance

- Electric or hydraulic height adjustment
- Height adjustment from 490-950mm
- Adjustable angle backrest
 - Manual -25 to +90 degrees
 - Electric -22 to +90 degrees
- Adjustable angle footrest from -25 to +75 degrees
- Anti-trap gas struts fitted with release levers used on the back & footrest sections (optional electric backrest)
- Retractable castors fitted to both ends to assist with movement & positioning
- One adjustable foot fitted to allow levelling on uneven floors
- Clearance beneath frame allows access for mobile hoists
- Electric models (230V ~, 50/60H) fitted with a UK 3 pin plug & available with a hand or foot switch
- Hydraulic models use a foot pump pedal positioned on both sides of the couch
- Seamless upholstery using flame retardant anti-microbial vinyl
- Frames prepared to accept optional accessories
- Maximum capacity 225kg

Dimensions (w x d x h)

- 630 x 1790 x 490-950mm

Standard Colours

- Paint - White
- Vinyl - Bristol Blue

Options

- E02 - Paper Roll Holder
- E03 - Side Support Rails (Pair)
- E04 - Side Support Rails C/W Cushions (Pair)
- E05 - Breather Hole & Plug
- E06 - Battery Back Up
- E07 - Height Adjustable Armrests (Pair)
- E08 - Infusion Pole

**Service
Contact us
for details**

Item	Description	Weight
EC1405/VBB	Hydraulic	70.3kg
EC1410/VBB	Electric, Hand Switch	70.3kg
EC1415/VBB	Electric, Foot Switch	70.3kg
EC1420/VBB	Electric with Electric Backrest - Hand Switch	72.6kg
EC1425/VBB	Electric with Electric Backrest - Foot Switch	72.6kg

Alternative colours available at extra cost. Change suffix 'VBB' on the product code with any of the following i.e. Hydraulic in Sand Dune - EC1405/VSD

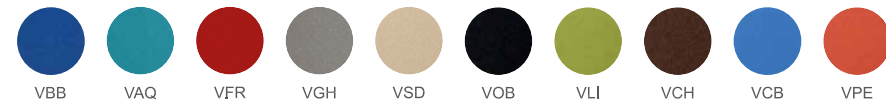

Examination & Treatment Couch Four Section, Mobile

Features

- BS 2838-2: 1991 Examination & general treatment couches, build, performance & safety specifications
- EN 60601-1:2006+A12:2014 Medical electrical equipment. General requirements for basic safety & essential performance

- Electric or hydraulic height adjustment
- Height adjustment from 490-950mm
- Adjustable angle backrest
 - Manual -25 to +90 degrees
 - Electric -22 to +90 degrees
- Adjustable angle footrest from -25 to +75 degrees
- Anti-trap gas struts fitted with release levers used on the back & footrest sections (optional electric backrest)
- 125mm swivel castors featuring a central locking & steering facility
- Clearance beneath frame allows access for mobile hoists
- Electric models (230V ~, 50/60H) fitted with a UK 3 pin plug & available with a hand or foot switch
- Hydraulic models use a foot pump pedal positioned on both sides of the couch
- Seamless & contoured upholstery using flame retardant & anti-microbial vinyl
- Swing down side support rails fitted to either side
- Frames prepared to accept optional accessories
- Maximum capacity 225kg

Dimensions (w x d x h)

- 630 x 1790 x 490-950mm

Standard Colours

- Paint - White
- Vinyl - Bristol Blue

Options

- E02 - Paper Roll Holder
- E04/U - Side Support Rails C/W Cushions Upgrade (Pair)
- E05 - Breather Hole & Plug
- E06 - Battery Back Up

Item	Description	Weight
EC1430/VBB	Hydraulic	76.6kg
EC1435/VBB	Electric, Hand Switch	76.6kg
EC1440/VBB	Electric, Foot Switch	76.6kg
EC1445/VBB	Electric with Electric Backrest - Hand Switch	78.9kg
EC1450/VBB	Electric with Electric Backrest - Foot Switch	78.9kg

Alternative colours available at extra cost. Change suffix 'VBB' on the product code with any of the following i.e. Electric, Hand Switch in Lime - EC1435/VLI

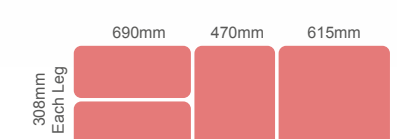
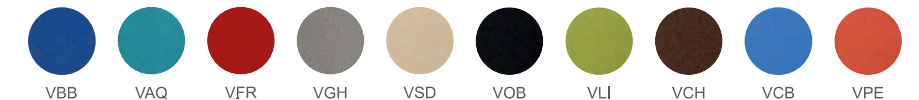

Hand Switch



Foot Switch



EC020/VBB

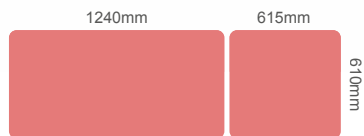

Hand Switch



Foot Switch

Alternative colours available at extra cost. Change suffix 'VBB' on the product code with any of the following i.e. Electric, Foot Switch in Chocolate - EC020/VCH

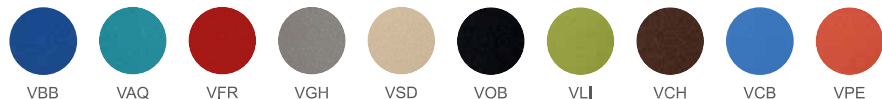

Examination & Treatment Couch Two Section, Vertical Lift

Features

- BS 2838-2: 1991 Examination & general treatment couches, build, performance & safety specifications
- EN 60601-1:2006+A12:2014 Medical electrical equipment. General requirements for basic safety & essential performance
- Scissor action provides vertical lift, ideal for use in confined areas where space is limited
- Height adjustment from 560-1000mm
- Adjustable angle backrest 0 to +90 degrees
- Anti-trap gas strut fitted with a release lever used on the backrest section
- 125mm swivel braking castors
- Clearance beneath frame allows access for mobile hoists
- 230V ~, 50/60Hz actuator fitted with a UK 3 pin plug & available with a hand or foot switch
- Seamless upholstery using flame retardant anti-microbial vinyl
- Paper roll holder (suitable for rolls max 510mm wide x 200mm diameter)
- Frames prepared to accept optional accessories
- Maximum capacity 190kg

Dimensions (w x d x h)

- 610 x 1860 x 560-1000mm

Standard Colours

- Paint - White
- Vinyl - Bristol Blue

Options

- EC905 - Side Support Rails (Pair)
- EC920 - Breather Hole & Plug

Service Contract
Contact us for details

Item	Description	Weight
EC015/VBB	Electric, Hand Switch	54.0kg
EC020/VBB	Electric, Foot Switch	54.0kg

Examination & Treatment Couch Two Section, Fixed Height

Features

- Fixed height approx. 786mm
- Adjustable angle backrest 0 to +90 degrees using a ratchet
- Adjustable feet to allow levelling on uneven floors
- Seamless upholstery using flame retardant anti-microbial vinyl
- Paper roll holder fitted to foot end (suitable for rolls max 510mm wide x 200mm diameter)
- Self-assembly model flat packed making it easier to ship
- Frames prepared to accept optional accessories
- Maximum capacity 125kg

Dimensions (w x d x h)

- 610 x 1860 x 795mm

Standard Colours

- Paint - White
- Vinyl - Bristol Blue

Options

- EC900 - Drawer
- EC935 - Drop Down Side Rails (Pair)



EC010/VBB

Item	Description	Weight
EC005/VBB	Examination Couch - Assembled	29.0kg
EC010/VBB	Examination Couch - Self Assembly	29.0kg



EC005/VBB

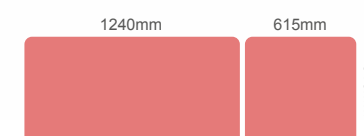

Alternative colours available at extra cost. Change suffix 'VBB' on the product code with any of the following i.e. Assembled Couch in Chocolate - EC005/VCH

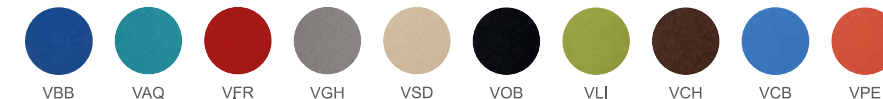

Leg Rest - Adjustable

Features

- Independently adjustable legs
- Height & angle adjustment from 355-510mm
- Seamless upholstery using flame retardant anti-microbial vinyl
- Maximum capacity 25kg

Dimensions (w x d x h)

- Overall Dimensions - 460 x 305 x 350-510mm
- Upholstered Pad - 460 x 305mm

Standard Colours

- Paint - White
- Vinyl - Bristol Blue



CS/28/VBB



CS/28/VFR



CS/28/VSD

Alternative colours available at extra cost. Change suffix 'VBB' on the product code

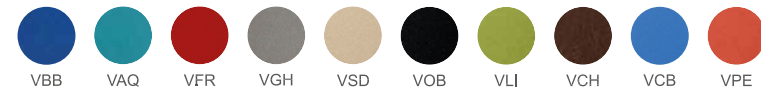

Item	Description	Weight
CS/28/VBB	Leg Rest - Adjustable	3.5kg

Arm / Leg Rest - Adjustable

Features

- Four leg stand
- Height & angle adjustment from 495-750mm / 17 degrees
- Seamless upholstery using flame retardant anti-microbial vinyl
- Maximum capacity 15kg

Dimensions (w x d x h)

- Overall Dimensions - 420 x 490 x 495-750mm
- Upholstered Pad - 380 x 130mm

Standard Colours

- Paint - White
- Vinyl - Bristol Blue



G/16/TILT/VLI



G/16/TILT/VBB

Alternative colours available at extra cost. Change suffix 'VBB' on the product code



Item	Description	Weight
G/16/TILT/VBB	Arm / Leg Rest - Adjustable	3.5kg

Couch Steps One & Two Tread

Features

- Non-slip rubber feet & tread
- Tread dimension 460 x 250mm
- Tread Heights
 - One Tread - 180mm
 - Two Tread - 185 & 365mm
- Available with a handle for additional safety
- Handle height max. 1005mm
- Maximum capacity 125kg

Standard Colours

- Paint - White



CS005



CS015



CS010

Item	Description	Overall Dimensions (w x d x h)	Weight
CS005	Couch Step - One Tread	519 x 284 x 228mm	4.4kg
CS010	Couch Step - One Tread, Handle	519 x 284 x 1005mm	6.0kg
CS015	Couch Step - Two Tread	519 x 599 x 405mm	9.6kg



EC2215/VBB

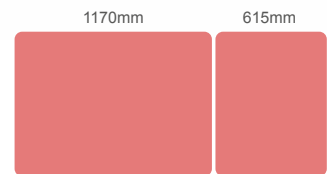

Hand Switch



Foot Switch

Examination & Treatment Couch Two Section, Bariatric

Features

- BS 2838-2: 1991 Examination & general treatment couches, build, performance & safety specifications
- EN 60601-1:2006+A12:2014 Medical electrical equipment. General requirements for basic safety & essential performance

- Electric height adjustment
- Height adjustment from 520-950mm
- Adjustable angle backrest
 - Manual -25 to +90 degrees
 - Electric -22 to +90 degrees
- Anti-trap gas strut fitted with a release lever used on the backrest section (optional electric)
- Retractable castors fitted to both ends to assist with movement & positioning
- One adjustable foot fitted to allow levelling on uneven floors
- Clearance beneath frame allows access for mobile hoists
- 230V ~, 50/60Hz actuator fitted with a UK 3 pin plug & available with a hand or foot switch
- Seamless upholstery using flame retardant antimicrobial vinyl
- Frames prepared to accept optional accessories
- Maximum capacity 325kg

Dimensions (w x d x h)

- 850 x 1790 x 520-950mm

Standard Colours

- Paint - White
- Vinyl - Bristol Blue

Options

- E03 - Side Support Rails (Pair)
- E04 - Side Support Rails C/W Cushions (Pair)
- E07 - Height Adjustable Armrests (Pair)
- E08 - Infusion Pole
- E18 - Battery Back Up
- E19 - Paper Roll Holder
- E21 - Breather Hole & Plug

**Service
Contract
Contact us for
details**

Item	Description	Weight
EC2205/VBB	Electric, Hand Switch	79.0kg
EC2210/VBB	Electric, Foot Switch	79.0kg
EC2215/VBB	Electric with Electric Backrest - Hand Switch	81.3kg
EC2220/VBB	Electric with Electric Backrest - Foot Switch	81.3kg

Alternative colours available at extra cost. Change suffix 'VBB' on the product code with any of the following i.e. Electric with Electric Backrest - Hand Switch in Peach - EC2215/VPE



Examination & Treatment Couch Two Section, Mobile, Bariatric

Features

- BS 2838-2: 1991 Examination & general treatment couches, build, performance & safety specifications
- EN 60601-1:2006+A12:2014 Medical electrical equipment. General requirements for basic safety & essential performance

- Electric height adjustment
- Height adjustment from 520-950mm
- Adjustable angle backrest
 - Manual -25 to +90 degrees
 - Electric -22 to +90 degrees
- Anti-trap gas strut fitted with a release lever used on the backrest section (optional electric)
- 125mm swivel castors featuring a central locking & steering facility
- Clearance beneath frame allows access for mobile hoists
- 230V ~, 50/60Hz actuator fitted with a UK 3 pin plug & available with a hand or foot switch
- Seamless upholstery using flame retardant antimicrobial vinyl
- Swing down side support rails fitted to either side
- Frames prepared to accept optional accessories
- Maximum capacity 325kg

Dimensions (w x d x h)

- 850 x 1790 x 520-950mm

Standard Colours

- Paint - White
- Vinyl - Bristol Blue

Options

- E04/U - Side Support Rails C/W Cushions Upgrade (Pair)
- E18 - Battery Back Up
- E19 - Paper Roll Holder
- E21 - Breather Hole & Plug

Item	Description	Weight
EC2225/VBB	Electric, Hand Switch	85.2kg
EC2230/VBB	Electric, Foot Switch	85.2kg
EC2235/VBB	Electric with Electric Backrest - Hand Switch	87.5kg
EC2240/VBB	Electric with Electric Backrest - Foot Switch	87.5kg

Alternative colours available at extra cost. Change suffix 'VBB' on the product code with any of the following i.e. Electric with Electric Backrest - Foot Switch in Bristol Blue - EC2240/VBB

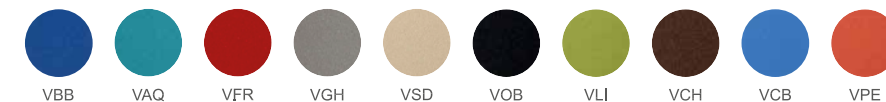

EC2225/VBB

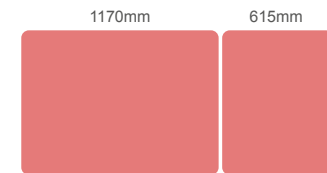

Hand Switch



Foot Switch



EC2305/VBB

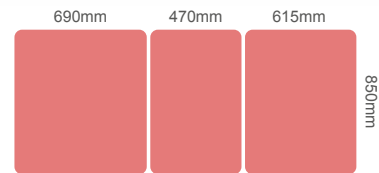

Hand Switch



Foot Switch

Examination & Treatment Couch Three Section, Bariatric

Features

- BS 2838-2: 1991 Examination & general treatment couches, build, performance & safety specifications
- EN 60601-1:2006+A12:2014 Medical electrical equipment. General requirements for basic safety & essential performance

- Electric height adjustment
- Height adjustment from 520-950mm
- Adjustable angle backrest
 - Manual -25 to +90 degrees
 - Electric -22 to +90 degrees
- Adjustable angle footrest from -25 to +75 degrees
- Anti-trap gas strut fitted with a release lever used on the back & footrest sections (optional electric backrest)
- Retractable castors fitted to both ends to assist with movement & positioning
- One adjustable foot fitted to allow levelling on uneven floors
- Clearance beneath frame allows access for mobile hoists
- 230V ~, 50/60Hz actuator fitted with a UK 3 pin plug & available with a hand or foot switch
- Seamless upholstery using flame retardant antimicrobial vinyl
- Frames prepared to accept optional accessories
- Maximum capacity 325kg

Dimensions (w x d x h)

- 850 x 1790 x 490-950mm

Standard Colours

- Paint - White
- Vinyl - Bristol Blue

Options

- E03 - Side Support Rails (Pair)
- E04 - Side Support Rails C/W Cushions (Pair)
- E07 - Height Adjustable Armrests (Pair)
- E08 - Infusion Pole
- E18 - Battery Back Up
- E19 - Paper Roll Holder
- E21 - Breather Hole & Plug



Item	Description	Weight
EC2305/VBB	Electric, Hand Switch	81.8kg
EC2310/VBB	Electric, Foot Switch	81.8kg
EC2315/VBB	Electric with Electric Backrest - Hand Switch	84.1kg
EC2320/VBB	Electric with Electric Backrest - Foot Switch	84.1kg

Alternative colours available at extra cost. Change suffix 'VBB' on the product code with any of the following i.e. Electric with Electric Backrest - Hand Switch in Peach - EC2315/VPE

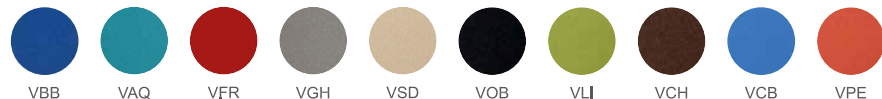

Examination & Treatment Couch Three Section, Mobile, Bariatric

Features

- BS 2838-2: 1991 Examination & general treatment couches, build, performance & safety specifications
- EN 60601-1:2006+A12:2014 Medical electrical equipment. General requirements for basic safety & essential performance

- Electric height adjustment
- Height adjustment from 520-950mm
- Adjustable angle backrest
 - Manual -25 to +90 degrees
 - Electric -22 to +90 degrees
- Adjustable angle footrest from -25 to +75 degrees
- Anti-trap gas strut fitted with a release lever used on the back & footrest sections (optional electric backrest)
- 125mm swivel castors featuring a central locking & steering facility
- Clearance beneath frame allows access for mobile hoists
- 230V ~, 50/60Hz actuator fitted with a UK 3 pin plug & available with a hand or foot switch
- Seamless upholstery using flame retardant antimicrobial vinyl
- Swing down side support rails fitted to either side
- Frames prepared to accept optional accessories
- Maximum capacity 325kg

Dimensions (w x d x h)

- 850 x 1790 x 520-950mm

Standard Colours

- Paint - White
- Vinyl - Bristol Blue

Options

- E04/U - Side Support Rails C/W Cushions Upgrade (Pair)
- E18 - Battery Back Up
- E19 - Paper Roll Holder
- E21 - Breather Hole & Plug

Item	Description	Weight
EC2325/VBB	Electric, Hand Switch	88.0kg
EC2330/VBB	Electric, Foot Switch	88.0kg
EC2335/VBB	Electric with Electric Backrest - Hand Switch	90.3kg
EC2340/VBB	Electric with Electric Backrest - Foot Switch	90.3kg



EC2340/VBB

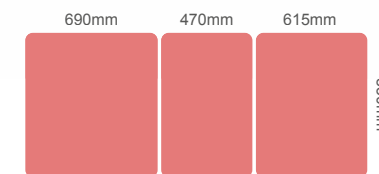

Hand Switch



Foot Switch

Alternative colours available at extra cost. Change suffix 'VBB' on the product code with any of the following i.e. Electric, Foot Switch in Flame Red - EC2330/VFR

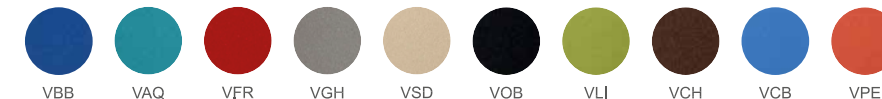



EC2405/VBB

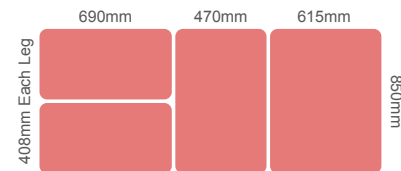

Hand Switch



Foot Switch

Examination & Treatment Couch Four Section, Bariatric

Features

- BS 2838-2: 1991 Examination & general treatment couches, build, performance & safety specifications
- EN 60601-1:2006+A12:2014 Medical electrical equipment. General requirements for basic safety & essential performance

- Electric height adjustment
- Height adjustment from 520-950mm
- Adjustable angle backrest
 - Manual -25 to +90 degrees
 - Electric -22 to +90 degrees
- Adjustable angle footrest from -25 to +75 degrees
- Anti-trap gas strut fitted with a release lever used on the back & footrest sections (optional electric backrest)
- Retractable castors fitted to both ends to assist with movement & positioning
- One adjustable foot fitted to allow levelling on uneven floors
- Clearance beneath frame allows access for mobile hoists
- 230V ~, 50/60Hz actuator fitted with a UK 3 pin plug & available with a hand or foot switch
- Seamless upholstery using flame retardant antimicrobial vinyl
- Frames prepared to accept optional accessories
- Maximum capacity 325kg

Dimensions (w x d x h)

- 850 x 1790 x 520-950mm

Standard Colours

- Paint - White
- Vinyl - Bristol Blue

Options

- E03 - Side Support Rails (Pair)
- E04 - Side Support Rails C/W Cushions (Pair)
- E07 - Height Adjustable Armrests (Pair)
- E08 - Infusion Pole
- E18 - Battery Back Up
- E19 - Paper Roll Holder
- E21 - Breather Hole & Plug

Item	Description	Weight
EC2405/VBB	Electric, Hand Switch	82.0kg
EC2410/VBB	Electric, Foot Switch	82.0kg
EC2415/VBB	Electric with Electric Backrest - Hand Switch	84.3kg
EC2420/VBB	Electric with Electric Backrest - Foot Switch	84.3kg

Alternative colours available at extra cost. Change suffix 'VBB' on the product code with any of the following i.e. Electric with Electric Backrest - Hand Switch in Graphite - EC2415/VGH



Examination & Treatment Couch Four Section, Mobile, Bariatric

Features

- BS 2838-2: 1991 Examination & general treatment couches, build, performance & safety specifications
- EN 60601-1:2006+A12:2014 Medical electrical equipment. General requirements for basic safety & essential performance

- Electric height adjustment
- Height adjustment from 520-950mm
- Adjustable angle backrest
 - Manual -25 to +90 degrees
 - Electric -22 to +90 degrees
- Adjustable angle footrest from -25 to +75 degrees
- Anti-trap gas strut fitted with a release lever used on the back & footrest sections (optional electric backrest)
- 125mm swivel castors featuring a central locking & steering facility
- Clearance beneath frame allows access for mobile hoists
- 230V ~, 50/60Hz actuator fitted with a UK 3 pin plug & available with a hand or foot switch
- Seamless upholstery using flame retardant antimicrobial vinyl
- Swing down side support rails fitted to either side
- Frames prepared to accept optional accessories
- Maximum capacity 325kg

Dimensions (w x d x h)

- 850 x 1790 x 520-950mm

Standard Colours

- Paint - White
- Vinyl - Bristol Blue

Options

- E04/U - Side Support Rails C/W Cushions Upgrade (Pair)
- E18 - Battery Back Up
- E19 - Paper Roll Holder
- E21 - Breather Hole & Plug

Item	Description	Weight
EC2425/VBB	Electric, Hand Switch	88.1kg
EC2430/VBB	Electric, Foot Switch	88.1kg
EC2435/VBB	Electric with Electric Backrest - Hand Switch	90.4kg
EC2440/VBB	Electric with Electric Backrest - Foot Switch	90.4kg

Alternative colours available at extra cost. Change suffix 'VBB' on the product code with any of the following i.e. Electric with Electric Backrest - Foot Switch in Onyx Black - EC2440/VOB

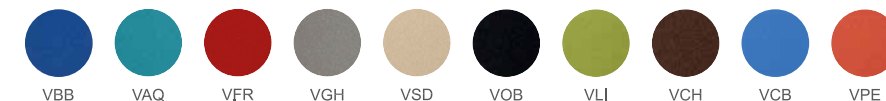

EC2425/VBB

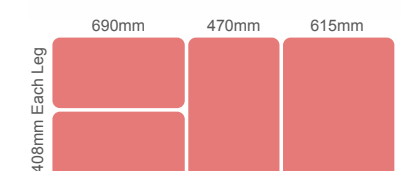

Hand Switch



Foot Switch

Service Contract
Contact us for details

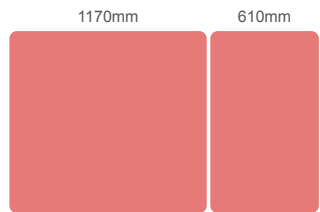

Hand Switch



Foot Switch

Examination & Treatment Couch Bobath Therapy

Features

- BS 2838-2: 1991 Examination & general treatment couches, build, performance & safety specifications
- EN 60601-1:2006+A12:2014 Medical electrical equipment. General requirements for basic safety & essential performance

- Electric or hydraulic height adjustment
- Height adjustment from 520-950mm
- Adjustable angle backrest
 - Manual -25 to +90 degrees
 - Electric -22 to +90 degrees
- Anti-trap gas strut fitted with a release lever used on the backrest section (optional electric)
- Retractable castors fitted to both ends to assist with movement & positioning
- One adjustable foot fitted to allow levelling on uneven floors
- Clearance beneath frame allows access for mobile hoists
- Electric models (230V ~, 50/60H) fitted with a UK 3 pin plug & available with a hand or foot switch
- Hydraulic models use a foot pump pedal positioned on both sides of the couch
- Seamless upholstery using flame retardant anti-microbial vinyl
- Frames prepared to accept optional accessories
- Maximum capacity 225kg

Dimensions (w x d x h)

- 1000 x 1790 x 520-950mm

Standard Colours

- Paint - White
- Vinyl - Bristol Blue

Options

- E16 - Side Support Rails (Pair)
- E17 - Side Support Rails C/W Cushions (Pair)
- E18 - Battery Back Up
- E19 - Paper Roll Holder
- E22 - Breather Hole & Plug

Item	Description	Weight
EC3205/VBB	Hydraulic	95.2kg
EC3210/VBB	Electric - Hand Switch	95.2kg
EC3215/VBB	Electric - Foot Switch	95.2kg
EC3220/VBB	Electric with Electric Backrest - Hand Switch	97.5kg
EC3225/VBB	Electric with Electric Backrest - Foot Switch	97.5kg

Alternative colours available at extra cost. Change suffix 'VBB' on the product code with any of the following i.e. Hydraulic in Sand Dune - EC3205/VSD

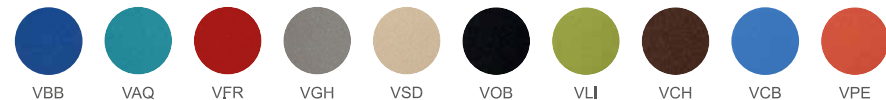

Examination & Treatment Couch Bobath Therapy, Mobile

Features

- BS 2838-2: 1991 Examination & general treatment couches, build, performance & safety specifications
- EN 60601-1:2006+A12:2014 Medical electrical equipment. General requirements for basic safety & essential performance

- Electric or hydraulic height adjustment
- Height adjustment from 520-950mm
- Adjustable angle backrest
 - Manual -25 to +90 degrees
 - Electric -22 to +90 degrees
- Anti-trap gas strut fitted with a release lever used on the backrest section (optional electric)
- 125mm swivel castors featuring a central locking & steering facility
- Clearance beneath frame allows access for mobile hoists
- Electric models (230V ~, 50/60H) fitted with a UK 3 pin plug & available with a hand or foot switch
- Hydraulic models use a foot pump pedal positioned on both sides of the couch
- Seamless upholstery using flame retardant anti-microbial vinyl
- Swing down side support rails fitted to either side
- Frames prepared to accept optional accessories
- Maximum capacity 225kg

Dimensions (w x d x h)

- 1000 x 1790 x 520-950mm

Standard Colours

- Paint - White
- Vinyl - Bristol Blue

Options

- E17/U - Side Support Rails C/W Cushions Upgrade (Pair)
- E18 - Battery Back Up
- E19 - Paper Roll Holder
- E22 - Breather Hole & Plug

Item	Description	Weight
EC3230/VBB	Hydraulic	103.2kg
EC3235/VBB	Electric - Hand Switch	103.2kg
EC3240/VBB	Electric - Foot Switch	103.2kg
EC3245/VBB	Electric with Electric Backrest - Hand Switch	105.5kg
EC3250/VBB	Electric with Electric Backrest - Foot Switch	105.5kg

Service Contract
Contact us for details

Alternative colours available at extra cost. Change suffix 'VBB' on the product code with any of the following i.e. Electric - Hand Switch in Lime - EC3235/VLI

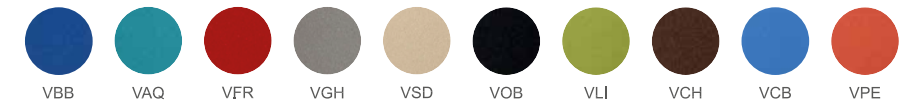

Hand Switch



Foot Switch



EC3110/VBB



Hand Switch



Foot Switch

Examination & Treatment Couch Mat Therapy

Features

- BS 2838-2: 1991 Examination & general treatment couches, build, performance & safety specifications
- EN 60601-1:2006+A12:2014 Medical electrical equipment. General requirements for basic safety & essential performance

- Electric or hydraulic height adjustment
- Height adjustment from 520-950mm
- Retractable castors fitted to both ends to assist with movement & positioning
- One adjustable foot fitted to allow levelling on uneven floors
- Clearance beneath frame allows access for mobile hoists
- Electric models (230V ~, 50/60H) fitted with a UK 3 pin plug & available with a hand or foot switch
- Hydraulic models use a foot pump pedal positioned on both sides of the couch
- Seamless upholstery using flame retardant anti-microbial vinyl
- Frames prepared to accept optional accessories
- Maximum capacity 225kg

Dimensions (w x d x h)

- 1000 x 1790 x 520-950mm

Standard Colours

- Paint - White
- Vinyl - Bristol Blue

Options

- E16 - Side Support Rails (Pair)
- E17 - Side Support Rails C/W Cushions (Pair)
- E18 - Battery Back Up
- E19 - Paper Roll Holder

Item	Description	Weight
EC3105/VBB	Hydraulic	96.9kg
EC3110/VBB	Electric - Hand Switch	96.9kg
EC3115/VBB	Electric - Foot Switch	96.9kg

Alternative colours available at extra cost. Change suffix 'VBB' on the product code with any of the following i.e. Electric - Foot Switch in Chocolate - EC3115/VCH

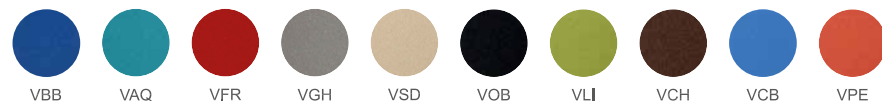

Examination & Treatment Couch Mat Therapy, Mobile



EC3125/VBB

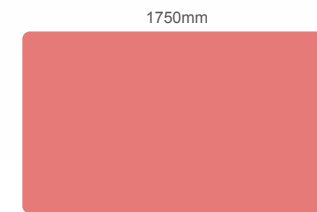

Hand Switch



Foot Switch

Features

- BS 2838-2: 1991 Examination & general treatment couches, build, performance & safety specifications
- EN 60601-1:2006+A12:2014 Medical electrical equipment. General requirements for basic safety & essential performance

- Electric or hydraulic height adjustment
- Height adjustment from 520-950mm
- 125mm swivel castors featuring a central locking & steering facility
- Clearance beneath frame allows access for mobile hoists
- Electric models (230V ~, 50/60H) fitted with a UK 3 pin plug & available with a hand or foot switch
- Hydraulic models use a foot pump pedal positioned on both sides of the couch
- Seamless upholstery using flame retardant anti-microbial vinyl
- Swing down side support rails fitted to either side
- Frames prepared to accept optional accessories
- Maximum capacity 225kg

Dimensions (w x d x h)

- 1000 x 1790 x 520-950mm

Standard Colours

- Paint - White
- Vinyl - Bristol Blue

Options

- E17/U - Side Support Rails C/W Cushions Upgrade (Pair)
- E18 - Battery Back Up
- E19 - Paper Roll Holder

Item	Description	Weight
EC3120/VBB	Hydraulic	104.9kg
EC3125/VBB	Electric - Hand Switch	104.9kg
EC3130/VBB	Electric - Foot Switch	104.9kg

Alternative colours available at extra cost. Change suffix 'VBB' on the product code with any of the following i.e. Electric - Hand Switch in Coastal Blue - EC3125/VCB

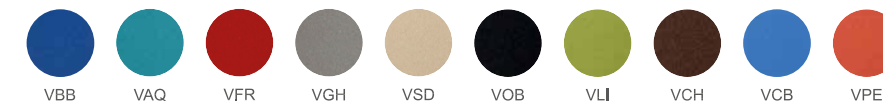



EC4305/VBB/E02/E13/E14

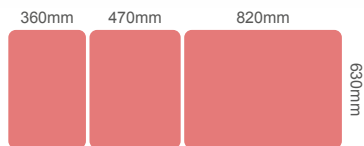

Hand Switch



Foot Switch

Alternative colours available at extra cost. Change suffix 'VBB' on the product code with any of the following i.e. Electric - Foot Switch in Peach - EC4315/VPE

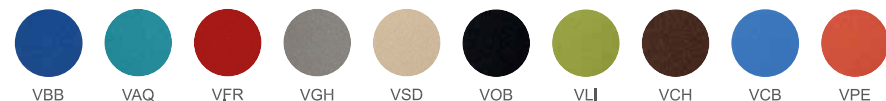

Examination & Treatment Chair Drop End, Three Section

Features

- BS 2838-2: 1991 Examination & general treatment couches, build, performance & safety specifications
- EN 60601-1:2006+A12:2014 Medical electrical equipment. General requirements for basic safety & essential performance

- Electric or hydraulic height adjustment
- Height adjustment from 490-950mm
- Adjustable angle backrest
 - Manual -25 to +90 degrees
 - Electric -22 to +90 degrees
- Adjustable angle footrest from -90 to +10 degrees
- Anti-trap gas struts fitted with release levers used on the back & footrest sections (optional electric backrest)
- Retractable castors fitted to both ends to assist with movement & positioning
- One adjustable foot fitted to allow levelling on uneven floors
- Clearance beneath frame allows access for mobile hoists
- Electric models (230V ~, 50/60H) fitted with a UK 3 pin plug & available with a hand or foot switch
- Hydraulic models use a foot pump pedal positioned on both sides of the couch
- Seamless upholstery using flame retardant anti-microbial vinyl
- Frames prepared to accept optional accessories
- Maximum capacity 225kg

Dimensions (w x d x h)

- 630 x 1710 x 490-950mm

Standard Colours

- Paint - White
- Vinyl - Bristol Blue

Options

- E02 - Paper Roll Holder
- E05 - Breather Hole & Plug
- E06 - Battery Back Up
- E07 - Height Adjustable Armrests (Pair)
- E08 - Infusion Pole
- E09 - Bowl
- E10 - Bowl Support
- E13 - Phlebotomy Armrests (Pair)
- E14 - Side Support Loops (Pair)

Item	Description	Weight
EC4305/VBB	Hydraulic	66.5kg
EC4310/VBB	Electric - Hand Switch	66.5kg
EC4315/VBB	Electric - Foot Switch	66.5kg
EC4320/VBB	Electric with Electric Backrest - Hand Switch	68.8kg
EC4325/VBB	Electric with Electric Backrest - Foot Switch	68.8kg

Examination & Treatment Chair Drop End, Four Section

Features

- BS 2838-2: 1991 Examination & general treatment couches, build, performance & safety specifications
- EN 60601-1:2006+A12:2014 Medical electrical equipment. General requirements for basic safety & essential performance

- Electric or hydraulic height adjustment
- Height adjustment from 490-950mm
- Adjustable angle backrest
 - Manual -25 to +90 degrees
 - Electric -22 to +90 degrees
- Adjustable angle footrest from -90 to +10 degrees
- Anti-trap gas struts fitted with release levers used on the back & footrest sections (optional electric backrest)
- Retractable castors fitted to both ends to assist with movement & positioning
- One adjustable foot fitted to allow levelling on uneven floors
- Clearance beneath frame allows access for mobile hoists
- Electric models (230V ~, 50/60H) fitted with a UK 3 pin plug & available with a hand or foot switch
- Hydraulic models use a foot pump pedal positioned on both sides of the couch
- Seamless upholstery using flame retardant anti-microbial vinyl
- Frames prepared to accept optional accessories
- Maximum capacity 225kg

Dimensions (w x d x h)

- 630 x 1710 x 490-950mm

Standard Colours

- Paint - White
- Vinyl - Bristol Blue

Options

- E02 - Paper Roll Holder
- E05 - Breather Hole & Plug
- E06 - Battery Back Up
- E07 - Height Adjustable Armrests (Pair)
- E08 - Infusion Pole
- E09 - Bowl
- E10 - Bowl Support
- E13 - Phlebotomy Armrests (Pair)
- E14 - Side Support Loops (Pair)

Item	Description	Weight
EC4405/VBB	Hydraulic	69.5kg
EC4410/VBB	Electric - Hand Switch	69.5kg
EC4415/VBB	Electric - Foot Switch	69.5kg
EC4420/VBB	Electric with Electric Backrest - Hand Switch	71.8kg
EC4425/VBB	Electric with Electric Backrest - Foot Switch	71.8kg



EC4410/VBB/E02

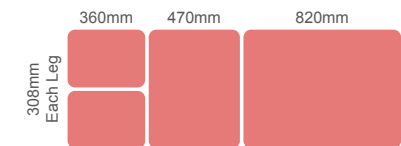

Hand Switch



Foot Switch

Alternative colours available at extra cost. Change suffix 'VBB' on the product code with any of the following i.e. Electric with Electric Backrest - Hand Switch in Bristol Blue - EC4420/VBB

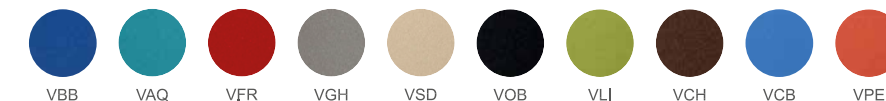

Service Contract
Contact us for details



EC4330/VBB

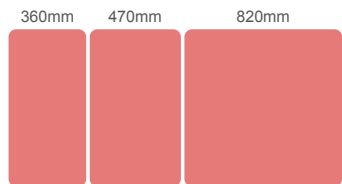

Hand Switch



Foot Switch

Alternative colours available at extra cost. Change suffix 'VBB' on the product code with any of the following i.e. Electric with Electric Backrest - Foot Switch in Aquamarine - EC4345/VAQ

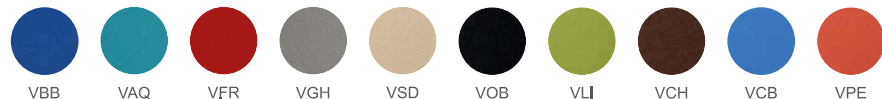

Examination & Treatment Chair Drop End, Three Section, Bariatric

Features

- BS 2838-2: 1991 Examination & general treatment couches, build, performance & safety specifications
- EN 60601-1:2006+A12:2014 Medical electrical equipment. General requirements for basic safety & essential performance

- Electric height adjustment
- Height adjustment from 520-950mm
- Adjustable angle backrest
 - Manual -25 to +90 degrees
 - Electric -22 to +90 degrees
- Adjustable angle footrest from -90 to +10 degrees
- Anti-trap gas strut fitted with a release lever used on the back & footrest sections
- Retractable castors fitted to both ends to assist with movement & positioning
- One adjustable foot fitted to allow levelling on uneven floors
- Clearance beneath frame allows access for mobile hoists
- 230V ~, 50/60H actuator fitted with a UK 3 pin plug & available with a hand or foot switch
- Seamless upholstery using flame retardant antimicrobial vinyl
- Frames prepared to accept optional accessories
- Maximum capacity 325kg

Dimensions (w x d x h)

- 850 x 1710 x 520-950mm

Standard Colours

- Paint - White
- Vinyl - Bristol Blue

Options

- E07 - Height Adjustable Armrests (Pair)
- E08 - Infusion Pole
- E09 - Bowl
- E10 - Bowl Support
- E13 - Phlebotomy Armrests (Pair)
- E14 - Side Support Loops (Pair)
- E18 - Battery Back Up
- E19 - Paper Roll Holder
- E21 - Breather Hole & Plug

Service Contract
Contact us for details

Item	Description	Weight
EC4330/VBB	Electric - Hand Switch	76.7kg
EC4335/VBB	Electric - Foot Switch	76.7kg
EC4340/VBB	Electric with Electric Backrest - Hand Switch	79.0kg
EC4345/VBB	Electric with Electric Backrest - Foot Switch	79.0kg

Examination & Treatment Chair Drop End, Four Section, Bariatric

Features

- BS 2838-2: 1991 Examination & general treatment couches, build, performance & safety specifications
- EN 60601-1:2006+A12:2014 Medical electrical equipment. General requirements for basic safety & essential performance

- Electric height adjustment
- Height adjustment from 520-950mm
- Adjustable angle backrest
 - Manual -25 to +90 degrees
 - Electric -22 to +90 degrees
- Adjustable angle footrest from -90 to +10 degrees
- Anti-trap gas strut fitted with a release lever used on the back & footrest sections
- Retractable castors fitted to both ends to assist with movement & positioning
- One adjustable foot fitted to allow levelling on uneven floors
- Clearance beneath frame allows access for mobile hoists
- 230V ~, 50/60H actuator fitted with a UK 3 pin plug & available with a hand or foot switch
- Seamless upholstery using flame retardant antimicrobial vinyl
- Frames prepared to accept optional accessories
- Maximum capacity 325kg

Dimensions (w x d x h)

- 850 x 1710 x 520-950mm

Standard Colours

- Paint - White
- Vinyl - Bristol Blue

Options

- E07 - Height Adjustable Armrests (Pair)
- E08 - Infusion Pole
- E09 - Bowl
- E10 - Bowl Support
- E13 - Phlebotomy Armrests (Pair)
- E14 - Side Support Loops (Pair)
- E18 - Battery Back Up
- E19 - Paper Roll Holder
- E21 - Breather Hole & Plug

Item	Description	Weight
EC4430/VBB	Electric - Hand Switch	77.6kg
EC4435/VBB	Electric - Foot Switch	77.6kg
EC4440/VBB	Electric with Electric Backrest - Hand Switch	79.9kg
EC4445/VBB	Electric with Electric Backrest - Foot Switch	79.9kg



EC4430/VBB

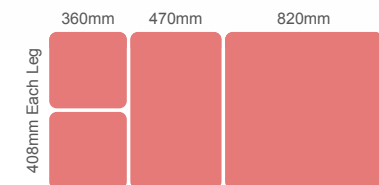

Hand Switch



Foot Switch

Alternative colours available at extra cost. Change suffix 'VBB' on the product code with any of the following i.e. Electric - Hand Switch in Flame Red - EC4430/VFR





CE



EC5305/VBB

HEIGHT
ADJUSTABLE

360mm 470mm 820mm

630mm



Hand Switch



Foot Switch

Alternative colours available at extra cost. Change suffix 'VBB' on the product code with any of the following i.e. Electric - Foot Switch in Graphite - EC5315/VGH

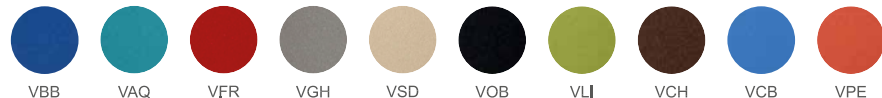

Phlebotomy Chair Variable Height

Features

- BS 2838-2: 1991 Examination & general treatment couches, build, performance & safety specifications
- EN 60601-1:2006+A12:2014 Medical electrical equipment. General requirements for basic safety & essential performance

- Electric or hydraulic height adjustment
- Height adjustment from 490-950mm
- Adjustable angle backrest
 - Manual -25 to +90 degrees
 - Electric -22 to +90 degrees
- Adjustable angle footrest from -90 to +10 degrees
- Anti-trap gas struts fitted with release levers used on the back & footrest sections (optional electric backrest)
- Retractable castors fitted to both ends to assist with movement & positioning
- One adjustable foot fitted to allow levelling on uneven floors
- Clearance beneath frame allows access for mobile hoists
- Electric models (230V ~, 50/60H) fitted with a UK 3 pin plug & available with a hand or foot switch
- Hydraulic models use a foot pump pedal positioned on both sides of the couch
- Seamless upholstery using flame retardant anti-microbial vinyl
- Adjustable polyurethane phlebotomy armrests
- Side support loops assist with patient mount & dismount (self-assembly)
- Paper roll holder (suitable for rolls max 510mm wide x 200mm diameter)
- Frames prepared to accept optional accessories
- Maximum capacity 225kg

Dimensions (w x d x h)

- 770 x 1710 x 490-950mm

Options

- E06 - Battery Back Up

Standard Colours

- Paint - White
- Vinyl - Bristol Blue

Item	Description	Weight
EC5305/VBB	Hydraulic	67.0kg
EC5310/VBB	Electric - Hand Switch	67.0kg
EC5315/VBB	Electric - Foot Switch	67.0kg
EC5320/VBB	Electric with Electric Backrest - Hand Switch	69.3kg
EC5325/VBB	Electric with Electric Backrest - Foot Switch	69.3kg

Phlebotomy Chair Variable Height, Bariatric

Features

- BS 2838-2: 1991 Examination & general treatment couches, build, performance & safety specifications
- EN 60601-1:2006+A12:2014 Medical electrical equipment. General requirements for basic safety & essential performance

- Electric height adjustment
- Height adjustment from 490-950mm
- Adjustable angle backrest
 - Manual -25 to +90 degrees
 - Electric -22 to +90 degrees
- Adjustable angle footrest from -90 to +10 degrees
- Anti-trap gas struts fitted with release levers used on the back & footrest sections
- Retractable castors fitted to both ends to assist with movement & positioning
- One adjustable foot fitted to allow levelling on uneven floors
- Clearance beneath frame allows access for mobile hoists
- 230V ~, 50/60H actuator fitted with a UK 3 pin plug & available with a hand or foot switch
- Seamless upholstery using flame retardant anti-microbial vinyl
- Adjustable polyurethane phlebotomy armrests
- Side support loops assist with patient mount & dismount (self-assembly)
- Paper roll holder (suitable for rolls max 510mm wide x 200mm diameter)
- Frames prepared to accept optional accessories
- Maximum capacity 325kg

Dimensions (w x d x h)

- 990 x 1710 x 520-950mm

Standard Colours

- Paint - White
- Vinyl - Bristol Blue

Options

- E18 - Battery Back Up

Item	Description	Weight
EC5330/VBB	Electric - Hand Switch	77.2kg
EC5335/VBB	Electric - Foot Switch	77.2kg
EC5340/VBB	Electric with Electric Backrest - Hand Switch	79.5kg
EC5345/VBB	Electric with Electric Backrest - Foot Switch	79.5kg



CE



EC5345/VBB

HEIGHT
ADJUSTABLE

360mm 470mm 820mm

850mm



Hand Switch



Foot Switch

Alternative colours available at extra cost. Change suffix 'VBB' on the product code with any of the following i.e. Electric with Electric Backrest - Hand Switch in Onyx Black - EC5340/VOB





CE



EC5000/VBB

Alternative colours available at extra cost. Change suffix 'VBB' on the product code with any of the following i.e. Fixed Height Phlebotomy Chair in Aquamarine - EC5000/VAQ

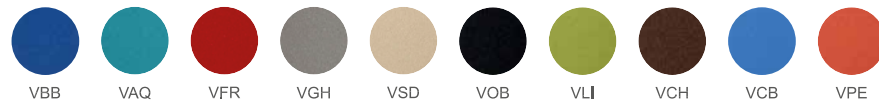

Phlebotomy Chair Fixed Height

Features

- BS EN 16139: 2013 Level 2. Furniture. Strength, durability & safety. Requirements for non-domestic seating
- BS 4875: Part 1: 2001 Test Level 4 (strength & durability)
- BS 7945: 1999 (stability)
- Certified for use up to 32 stone (203kg)
- Stable four leg design
- Black finish tubular frame
- Seamless upholstery using flame retardant anti-microbial vinyl
- Adjustable polyurethane phlebotomy armrest
- Armrest can be positioned on either side of the chair (additional armrest available if required)
- Maximum capacity 203kg

Dimensions (w x d x h)

- 620 x 580 x 800mm

Standard Colours

- Paint - Black
- Vinyl - Bristol Blue

Options

- E15 - Phlebotomy Armrest (Single)

Item	Description	Seat Height	Weight
EC5000/VBB	Fixed Height	485mm	15.0kg



Paper Roll Holder

E02 - E19

- Fitted to the head section
- Suitable for rolls max 510mm wide x 200mm diameter



Breather Hole & Plug

E05 - E21 - E22 - EC920

- Breather hole located in backrest section to improve patient comfort when in the prone position
- Supplied with a plug/insert



Height Adjustable Armrests (Pair)

E07

- Height adjustable easy clean moulded polyurethane armrests



Side Support Rails (Pair)

E03 - EC905 - E16

- Swing down side support rails
- Can be added to either one or both sides of the couch to provide additional safety for patients



Cushioned Side Support Rails (Pair)

E04 - E04/U - E17 - E17/U

- Vinyl upholstered swing down side support rails
- Can be added to either one or both sides of the couch to provide additional safety for patients
- Upgrade option for factory fitted side support rails (E04/U & E17/U)



Battery Back Up

E06 - E18

- Allows the couch to be lowered in a controlled manner in the event of a power failure
- Provides enough charge for 1-3 cycles



Infusion Pole

E08

- Height adjustable two hook infusion pole
- Cannot be fitted in conjunction with side support rails - E03, E04, E04/U, E16, E17, E17/U



Bowl

E09

- 360mm diameter 304 Grade stainless steel bowl



Side Support Loops (Pair)

E14

- Side support loops to assist with mount/dismount & provide patient security



Drawer

EC900

- Mounts beneath the couch frame offering additional storage space
- Compatible with EC005 & EC010



Leg Supports (Pair)

E12

- Fully adjustable easy clean moulded polyurethane leg supports



Bowl Support

E10

- Support to hold 360mm diameter 304 Grade stainless steel bowl
- Order bowl separately



Phlebotomy Armrest (Single)

E15

- Fully adjustable easy clean moulded polyurethane armrest
- Compatible with EC5000

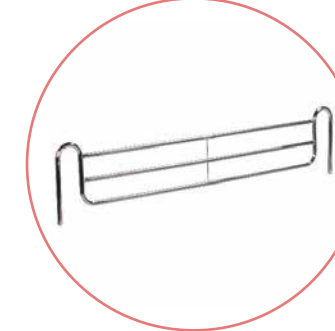

Drop Down Side Rails (Pair)

EC935

- Drop down side support rails
- Can be added to either one or both sides of the couch to provide additional safety for patients
- Compatible with EC005 & EC010



Lithotomy Stirrups (Pair)

E11

- Traditional lithotomy stirrups



Phlebotomy Armrests (Pair)

E13

- Fully adjustable easy clean moulded polyurethane armrests

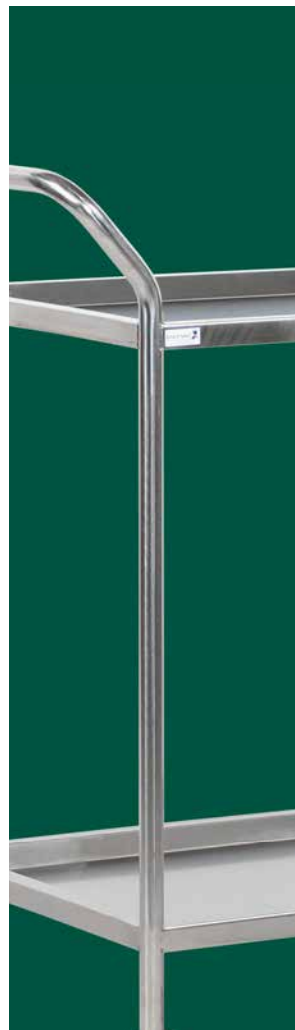

General Purpose Trolleys

Stainless Steel Trolleys	186
Polymer Trolleys	188
Mild Steel Trolleys	189



General Purpose Trolley Stainless Steel, Heavy Duty

Features

- Seamlessly welded from 304 grade stainless steel for strength & ease of cleaning
- Fixed shelves with three sides up & one down (shelf size 920 x 535mm)
- Available with two or three shelves, shelf heights
 - Two shelf - 280 & 860mm
 - Three shelf - 220, 540 & 860mm
- Maximum capacity per shelf 75kg
- 125mm pressed steel castors

Dimensions (w x d x h)

- No Ring Buffers - 970 x 540 x 1020mm
- Ring Buffers - 1045 x 615 x 1020mm

Standard Colours

- Stainless Steel

Options

- C008 - 125mm Castors, Heavy Duty Pressed Steel, 2 x Braking, 2 x Non-Braking (set of 4)

WT/37/2

Item	Description	Weight
WT/37/2	Stainless Steel - Heavy Duty, Two Shelves	28.0kg
WT/37/3	Stainless Steel - Heavy Duty, Three Shelves	37.5kg
WT/37/2/ZP010	Stainless Steel - Heavy Duty, Two Shelves, Ring Buffers	28.2kg
WT/37/3/ZP010	Stainless Steel - Heavy Duty, Three Shelves, Ring Buffers	37.7kg

General Purpose Trolley Stainless Steel, Light Duty

Features

- Seamlessly welded from 304 grade stainless steel for strength & ease of cleaning
- Fixed liquid retaining sunken shelves (shelf size 540 x 430mm)
- Available with two or three shelves, shelf heights
 - Two shelf - 250 & 870mm
 - Three shelf - 250, 560 & 870mm
- Maximum capacity per shelf 50kg
- 100mm pressed steel castors

Dimensions (w x d x h)

- No Ring Buffers - 990 x 510 x 1035mm
- Ring Buffers - 1065 x 585 x 1035mm

Standard Colours

- Stainless Steel



WT/33/SS/2/ZP005

WT/33/SS/3

Item	Description	Weight
WT/33/SS/2	Stainless Steel - Light Duty, Two Shelves	16.0kg
WT/33/SS/3	Stainless Steel - Light Duty, Three Shelves	22.0kg
WT/33/SS/2/ZP005	Stainless Steel - Light Duty, Two Shelves, Ring Buffers	16.2kg
WT/33/SS/3/ZP005	Stainless Steel - Light Duty, Three Shelves, Ring Buffers	22.2kg

General Purpose Trolley Polymer, Shallow Shelves

Features

- Easy to clean corrosion resistant high density polyethylene shelves (not suitable for use with automated washers)
- 11mm raised edge retains spills & prevents items from sliding off during transport
- Microban® product protection inhibits growth of bacteria, mould, mildew & fungi
- Chrome plated posts offers shelf adjustment in 25mm increments
- Available with two or three shelves in three sizes
 - Small - Shelf size 620 x 345mm
 - Easy grip handle & utility tray
 - Maximum capacity per shelf 60kg
 - 100mm pressed steel castors
 - Medium - Shelf size 690 x 475mm
 - Handle has built in recessed support channel to manage odd shaped items
 - Maximum capacity per shelf 60kg
 - 100mm pressed steel castors
 - Large - Shelf size 840 x 585mm
 - Handle has built in slot to hold scanners
 - Maximum capacity per shelf 75kg
 - 125mm pressed steel castors
- Self-assembly (supplied boxed)



Standard Colours

- Uprights - Chrome
- Shelves - Blue

Item	Shelves	Weight
Small - 800 x 465 x 900mm		
8MY1627-24BU	2	12.9kg
8MY1627-34BU	3	15.4kg
Medium - 873 x 595 x 900mm		
8MY2030-24BU	2	14.9kg
8MY2030-34BU	3	18.8kg
Large - 1022 x 703 x 936mm		
8MY2636-25BU	2	18.1kg
8MY2636-35BU	3	23.1kg



8MY1627-34BU



8BC2030-3DMB

General Purpose Trolley Polymer, Deep Shelves

Features

- Easy to clean corrosion resistant high density polyethylene shelves (not suitable for use with automated washers)
- 70mm deep shelves retains spills & prevents items from sliding off during transport
- Microban® product protection inhibits growth of bacteria, mould, mildew & fungi
- Chrome plated posts offers shelf adjustment in 25mm increments
- Available with two or three shelves in three sizes
 - Small - 800 x 546mm
 - Large - 948 x 686mm
- Max capacity shelf 68kg
- 100mm pressed steel castors
- Self-assembly (supplied boxed)

Standard Colours

- Uprights - Chrome
- Shelves - Blue

Item	Shelves	Weight
Small - 832 x 546 x 1041mm		
8BC2030-2DMB	2	13.0kg
8BC2030-3DMB	3	17.0kg
Large - 984 x 685 x 1041mm		
8BC2636-2DMB	2	15.9kg
8BC2636-3DMB	3	21.1kg

General Purpose Trolley Mild Steel, Laminate Shelves

Features

- Laminate shelves
- Available with two or three shelves in two sizes
- Shelf heights
 - Two shelf - 210 & 845mm
 - Three shelf - 210, 525 & 845mm
- Shelf size
 - Small - 705 x 445mm
 - Large - 855 x 445mm
- Maximum capacity per shelf 40kg
- 100mm pressed steel castors

Standard Colours

- Paint - Grey
- Shelf - Spearmint

Options

- ZP005 - Ring Buffer



GP015

Item	Description	Weight
Small - 972 x 533 x 1008mm		
GP005	Mild Steel - Two Laminate Shelves, Small	18.0kg
GP015	Mild Steel - Three Laminate Shelves, Small	23.0kg
Large - 1122 x 533 x 1008mm		
GP025	Mild Steel - Two Laminate Shelves, Large	20.0kg
GP035	Mild Steel - Three Laminate Shelves, Large	26.5kg

General Purpose Trolley Mild Steel, Aluminium Trays

Features

- Liquid retaining painted aluminium trays (depth 50mm)
- Available with two or three shelves in two sizes
- Shelf heights
 - Two shelf - 210 & 845mm
 - Three shelf - 210, 525 & 845mm
- Shelf size
 - Small - 705 x 445mm
 - Large - 855 x 445mm
- Maximum capacity per tray 40kg
- 100mm pressed steel castors

Standard Colours

- Paint - Grey

Options

- ZP005 - Ring Buffer



GP020







Item	Description	Weight
Small - 972 x 533 x 1008mm		
GP010	Mild Steel - Two Aluminium Trays, Small	16.5kg
GP020	Mild Steel - Three Aluminium Trays, Small	20.6kg
Large - 1122 x 533 x 1008mm		
GP030	Mild Steel - Two Aluminium Trays, Large	18.5kg
GP040	Mild Steel - Three Aluminium Trays, Large	23.7kg









HTM71 Storage Solutions

ScanCell® Carts	192
Distribution Trolleys	197
Open Transfer/Transport Trolleys	199
HTM71 Racking	200
Trays, Baskets, Dividers & Accessories	202

Type A - 600mm Insertion

					
706mm Cart Depth	905mm High	1055mm High	1205mm High	1503mm High	1803mm High
462mm Wide	4A1OF09	4A1OF10	4A1OF12	4A1OF15	4A1OF18
924mm Wide	4A2OF09	4A2OF10	4A2OF12	4A2OF15	4A2OF18
1386mm Wide	4A3OF09	4A3OF10	4A3OF12	4A3OF15	4A3OF18

Type B - 400mm Insertion

					
494mm Cart Depth	905mm High	1055mm High	1205mm High	1503mm High	1803mm High
662mm Wide	4B1OF09	4B1OF10	4B1OF12	4B1OF15	4B1OF18
1324mm Wide	4B2OF09	4B2OF10	4B2OF12	4B2OF15	4B2OF18
1986mm Wide	4B3OF09	4B3OF10	4B3OF12	4B3OF15	4B3OF18

ScanCell® Carts - Open Fronts



Features

- Mobile open front storage carts for use with 600 x 400mm modular trays & baskets
- Lightweight easyclean design
- Injection moulded ABS top/chassis with aluminium corner profiles, laminate sides & back
- Available as single, double and treble columns in a range of heights
- Fitted with angled/horizontal side panels to suit 400 or 600mm insertions
 - Type A - 600mm Insertions
 - Type B - 400mm Insertions
- 125mm castors, 2 off braking

Standard Colours

- Body - Grey

Options

- 4UR1A - Utility Rail, Type A (Cart Heights 905mm, 1055mm, 1205mm)
- 4UR1B - Utility Rail, Type B (Cart Heights 905mm, 1055mm, 1205mm)
- 4PR1A - Push Rail, Type A (Cart Heights 1503mm, 1803mm)
- 4PR1B - Push Rail, Type B (Cart Heights 1503mm, 1803mm)

See page 202 for Trays Baskets Accessories



4A1OF12 (trays & baskets not included)

4B1OF12 (trays & baskets not included)

ScanCell® Carts - Roller Shutters



Features

- Mobile storage carts fitted with roller shutters for use with 600 x 400mm modular trays & baskets
- Lightweight easyclean design
- Injection moulded ABS top/chassis with aluminium corner profiles, laminate sides & back, polypropylene roller shutter
- Available as single, double and treble columns in a range of heights
- Fitted with angled/horizontal side panels to suit 400 or 600mm insertions
 - Type A - 600mm Insertions
 - Type B - 400mm Insertions
- 125mm castors, 2 off braking

Standard Colours

- Body - Grey

Options

- 4UR1A - Utility Rail, Type A (Cart Heights 905mm, 1055mm, 1205mm)
- 4UR1B - Utility Rail, Type B (Cart Heights 905mm, 1055mm, 1205mm)
- 4PR1A - Push Rail, Type A (Cart Heights 1503mm, 1803mm)
- 4PR1B - Push Rail, Type B (Cart Heights 1503mm, 1803mm)







See page 202 for Trays Baskets Accessories









4A1RS12 (trays & baskets not included)

4B1RS10

Type A - 600mm Insertion

					
706mm Cart Depth	905mm High	1055mm High	1205mm High	1503mm High	1803mm High
462mm Wide	4A1RS09	4A1RS10	4A1RS12	4A1RS15	4A1RS18
924mm Wide	4A2RS09	4A2RS10	4A2RS12	4A2RS15	4A2RS18
1386mm Wide	4A3RS09	4A3RS10	4A3RS12	4A3RS15	4A3RS18

Type B - 400mm Insertion

					
494mm Cart Depth	905mm High	1055mm High	1205mm High	1503mm High	1803mm High
662mm Wide	4B1RS09	4B1RS10	4B1RS12	4B1RS15	4B1RS18
1324mm Wide	4B2RS09	4B2RS10	4B2RS12	4B2RS15	4B2RS18
1986mm Wide	4B3RS09	4B3RS10	4B3RS12	4B3RS15	4B3RS18

Type A - 600mm Insertion

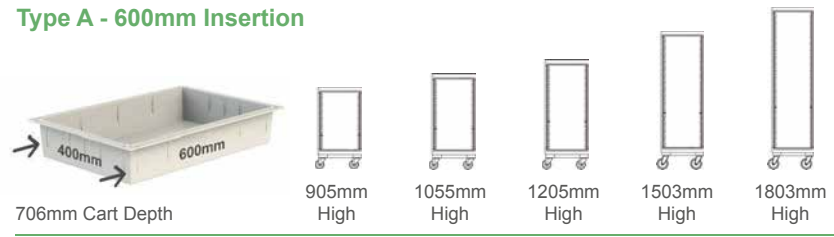

706mm Cart Depth						
462mm Wide		4A1DR09	4A1DR10	4A1DR12	4A1DR15	4A1DR18
924mm Wide		4A2DR09	4A2DR10	4A2DR12	4A2DR15	4A2DR18
1386mm Wide		4A3DR09	4A3DR10	4A3DR12	4A3DR15	4A3DR18

Type B - 400mm Insertion

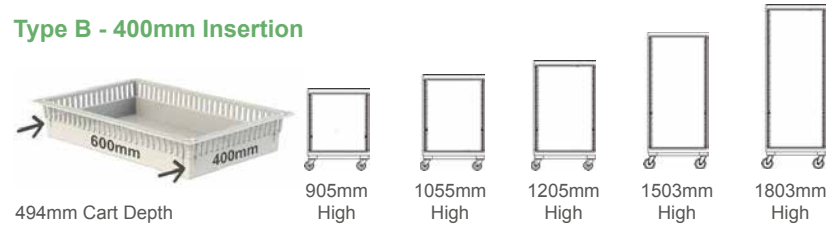

494mm Cart Depth						
662mm Wide		4B1DR09	4B1DR10	4B1DR12	4B1DR15	4B1DR18
1324mm Wide		4B2DR09	4B2DR10	4B2DR12	4B2DR15	4B2DR18
1986mm Wide		4B3DR09	4B3DR10	4B3DR12	4B3DR15	4B3DR18

ScanCell® Carts - Doors



Features

- Mobile storage carts fitted with doors for use with 600 x 400mm modular trays & baskets
- Lightweight easy clean design
- Injection moulded ABS top/chassis with aluminium corner profiles, laminate sides & back, post form/plastic finish doors
- Available as single, double and treble columns in a range of heights
- Fitted with angled/horizontal side panels to suit 400 or 600mm insertions
- Type A - 600mm Insertion - Single door for each column
 - Single Column - R/H Hinged
 - Double Column - R/H & L/H Hinged
 - Treble Column - 1 x R/H & 2 x L/H Hinged
- Type B - 400mm Insertion - Double doors for each column
- 125mm castors, 2 off braking
- For trays/baskets/stops & accessories please refer to page 202

Standard Colours

- Body - Grey

Options

- 4UR1A - Utility Rail, Type A (Cart Heights 905mm, 1055mm, 1205mm)
- 4UR1B - Utility Rail, Type B (Cart Heights 905mm, 1055mm, 1205mm)
- 4PR1A - Push Rail, Type A (Cart Heights 1503mm, 1803mm)
- 4PR1B - Push Rail, Type B (Cart Heights 1503mm, 1803mm)



4A1DR10
(trays & baskets not included)

4B1DR10

ScanCell® Carts - Vario Drawers



Features

- Mobile storage carts, lightweight easyclean design, fitted with vario drawers & supplied with trays
- Injection moulded ABS top/chassis with aluminium corner profiles, laminate sides & back
- Type B - 400mm Insertions
- Available as single, double and treble columns in a range of heights
- 50mm/100mm drawers can be subdivided (see page 203 for dividers & label holders)
- 125mm castors, 2 off braking

Dimensions (w x d x h)

- Single Column - 662 x 494 x Height
- Double Column - 1324 x 494 x Height
- Treble Column - 1986 x 494 x Height

Standard Colours

- Body/Drawers - Grey
- Drawer Handle - Blue

Options

- 4UR1B - Utility Rail (Cart Height - 905mm, 1055mm, 1205mm)
- 4PR1B - Push Rail (Cart Height - 1503mm)

Item	50mm Tray	100mm Tray	200mm Tray	300mm Tray
Height - 905mm				
4B1VD09/A	1	2	1	
4B1VD09/B		4		
4B1VD09/C	2	3		
4B2VD09/AA*	2	4	2	
4B3VD09/AAA**	3	6	3	
Height - 1055mm				
4B1VD10/D	1	3	1	
4B1VD10/E		5		
4B1VD10/F	2	4		
4B2VD10/DD*	2	6	2	
4B3VD10/DDD**	3	9	3	
Height - 1205mm				
4B1VD12/G	1	4	1	
4B1VD12/H	2	2	2	
Height - 1503mm				
4B1VD15/I	1	6	1	
4B1VD15/J	1	4	1	1

*double column **treble column

TYPE B - 400mm Insertion



4B1VD09/A

4B1VD15/I

ScanCell® Carts - Telescopic Drawers

Features

- Mobile storage carts with telescopic drawers supplied with 600 x 400mm modular trays & baskets
- Lightweight easy clean design
- Injection moulded ABS top/chassis with aluminium corner profiles, laminate sides & back
- Type B - 400mm Insertions
- Available as single, double and treble columns in a range of heights
- Fitted with horizontal side panels to suit 400 insertions
- Drawers can be subdivided (see page 203 for dividers & label holders)
- 125mm castors, 2 off braking

Dimensions (w x d x h)

- Single Column - 662 x 494 x Height
- Double Column - 1324 x 494 x Height

Standard Colours

- Body/Drawers - Grey

Options

- 4UR1B - Utility Rail (Cart Height - 905mm, 1055mm, 1205mm)

Item	50mm Tray	100mm Tray	200mm Basket
Height - 905mm			
4B1TD09/A	1	2	1
4B1TD09/B		4	
4B1TD09/C	2	3	
4B2TD09/AA *	2	4	2
Height - 1055mm			
4B1TD10/D	1	3	1
4B1TD10/E		5	
4B1TD10/F	2	4	
4B1TD10/G	10		
Height - 1205mm			
4B1TD12/H	1	4	1
4B1TD12/I	2	5	
4B1TD12/J	6	3	

*double column



4B1TD09/A



4B1TD10/D

ScanCell® Carts - Compact

Features

- Single column mobile compact carts for use with 300 x 400mm modular trays & baskets
- Lightweight easyclean design
- Injection moulded ABS top/chassis with aluminium corner profiles, laminate sides & back
- Available with drawers with telescopic runners
 - Type D - 400mm Insertions
- 125mm castors, 2 off braking
- Trays/baskets/drawers can be subdivided

Dimensions (w x d x h)

- 462 x 494 x 905mm

Options

- 4UR1B - Utility Rail (Type B)

Standard Colours

- Body/Drawers - Grey

This is a small selection of a large configurable range. Please contact our customer services team to discuss your requirements



4D1TD09/A shown with optional utility rail

Item	50mm Tray	100mm Tray	200mm Basket
4D1TD09/A	1	2	1
4D1TD09/B		4	

Distribution Trolleys - Compact

Features

- Single column compact distribution trolleys for use with 300 x 400mm modular trays, baskets & stops
- Available in mild/stainless steel
 - Mild Steel - Welded & powder coated
 - 304 Grade Stainless Steel - Seamlessly welded for ease of cleaning
- Trays & baskets can be supported on the upper & lower frame (optional solid grade laminate worktop)
- 4 stops required per tray / basket
- Runners allow trays to be accessed from either side (4 stops required per tray/basket)
 - Type D - 400mm insertion
- 75mm castors
- For trays/baskets/stops & accessories please refer to page 202

Dimensions (w x d x h)

- 360 x 460 x 850mm

Standard Colours

- Paint - Grey

Options

- ZP010 - Ring Buffers
- 4D1SLWT- Solid Grade Laminate Worktop



4D1DSTCS (trays & baskets not included)

Item	Description
4D1DSTCM	Compact, Single Column, Mild Steel
4D1DSTCS	Compact, Single Column, Stainless Steel



4A2DSTS
(trays & baskets not included)

4A1DSTM
(trays & baskets not included)

Distribution Trolleys

Features

- Single & double column distribution trolleys for use with 600 x 400mm modular trays & baskets
- Available in mild/stainless steel
 - Mild Steel - Welded & powder coated
 - 304 Grade Stainless Steel - Seamlessly welded for ease of cleaning
- Trays & baskets can be supported on the upper & lower frame (optional solid grade laminate worktop)
- Runners allow trays to be accessed from either side (4 stops required per tray/basket)
 - Type A - 600mm insertion
 - Type B - 400mm insertion
- 75mm castors
- For trays/baskets/stops & accessories please refer to page 202

Standard Colours

- Paint - Grey

Options

- ZP010 - Ring Buffers
- 4A1SLWT - Solid Grade Laminate Worktop, Single Column (Type A)
- 4A2SLWT - Solid Grade Laminate Worktop, Double Column (Type A)
- 4B1SLWT - Solid Grade Laminate Worktop, Single Column (Type B)



Item	Description	Overall Dimensions (w x d x h)
Mild Steel		
4A1DSTM	Single Column, Type A, Mild Steel	460 x 655 x 850mm
4A2DSTM	Double Column, Type A, Mild Steel	895 x 655 x 850mm
4B1DSTM	Single Column, Type B, Mild Steel	660 x 455 x 850mm
Stainless Steel		
4A1DSTS	Single Column, Type A, Stainless Steel	460 x 655 x 850mm
4A2DSTS	Double Column, Type A, Stainless Steel	895 x 655 x 850mm
4B1DSTS	Single Column, Type B, Stainless Steel	660 x 455 x 850mm

Open Transfer / Transport Trolleys

Features

- Single, double & treble column transfer/transport trolleys for use with 600 x 400mm modular trays & baskets
- Available in mild/stainless steel
 - Mild Steel - Welded & powder coated
 - 304 Grade Stainless Steel - Seamlessly welded for ease of cleaning
- Runners allow trays to be accessed from either side (4 stops required per tray/basket)
 - Type A - 600mm insertion
- Push handles at either end
- Ring buffers to protect the trolley/fabric of the building
- Castors
 - Single/Double Column - 125mm castors, 2 off braking
 - Treble Column - 200mm heavy duty cushioned castors, 2 off fixed, 2 off swivel braking
- For trays/baskets/stops and accessories please refer to page 202

Standard Colours

- Paint - Grey

Options

- 4A1OTTNC - Nylon Cover (Single Column)
- 4A2OTTNC - Nylon Cover (Double Column)
- 4A3OTTNC - Nylon Cover (Treble Column)

Item	Description	Overall Dimensions (w x d x h)
Mild Steel		
4A1OTTM	Single Column, Type A, Mild Steel	665 x 725 x 1555mm
4A2OTTM	Double Column, Type A, Mild Steel	1100 x 725 x 1555mm
4A3OTTM	Treble Column, Type A, Mild Steel	1535 x 725 x 1635mm
Stainless Steel		
4A1OTTSS	Single Column, Type A, Stainless Steel	665 x 725 x 1555mm
4A2OTTSS	Double Column, Type A, Stainless Steel	1100 x 725 x 1555mm
4A3OTTSS	Treble Column, Type A, Stainless Steel	1535 x 725 x 1635mm



4A1OTTSS
(trays & baskets not included)

4A3OTTSS

TYPE A - 600mm Insertion



This is a small selection of a large configurable range. Please contact our customer services team to discuss your requirements



Room Design &
Installation Service
Available



2HH-7532293
Wall Mounting Bracket



2HH-7532277
10mm Plastic Cover Cap

4HH-HTM71/S1/400
Runners, trays, baskets, dividers & angle
brackets not included (order separately)

Components

- 2HH-7532301-HH - Base Unit, Type A, 600mm Insertion (x 1)
- 2HH-7532311 - Extension Unit, Type A, 600mm Insertion (x 1)
- 2HH-7532356 - Runners, Type A, 600mm Insertion (pair)
- 2HH-7532329 - Angle Adaptor Plate, Type A, 600mm Insertion (pair)
- 2HH-7532304-HH - Base Unit, Type B, 400mm Insertion (x 1)
- 2HH-7532314 - Extension Unit, Type B, 400mm Insertion (x 1)
- 2HH-7532355 - Runners, Type B, 400mm Insertion (pair)
- 2HH-7532328 - Angle Adaptor Plate, Type B, 400mm Insertion (pair)
- 2HH-7532320 - Adjustable Foot Set (x 4)
- 2HH-7532321 - Adjustable Foot Set (x 2)
- 2HH-7532322 - 50mm Pressed Steel Castors (2 x Braking / 2 x Non-Braking)
- 2HH-7532323 - 50mm Pressed Steel Castors (1 x Braking / 1 x Non-Braking)
- 2HH-7532324 - 80mm Pressed Steel Castors (2 x Braking / 2 x Non-Braking)
- 2HH-7532325 - 80mm Pressed Steel Castors (1 x Braking / 1 x Non-Braking)

HTM71 Racking

Features

- Fully configurable freestanding modular racking for use with 600 x 400mm modular trays & baskets
- Available to suit 600 or 400mm insertions
 - Type A - 600mm insertion
 - Type B - 400mm insertion
- Trays & baskets supported on adjustable moulded plastic/glass fibre runners
- Runners can be positioned horizontal or angled (approx. 25 degrees - requires angle adaptor brackets)
- Integral stops on the runners allow trays/baskets to be accessible in two positions
 - Straight (approx. 5 degrees)
 - Angled (approx. 25 degrees)
- Runners offer pass through facility allowing access on either side
- Anodised extruded aluminium uprights & cross members
- Bolted construction using high quality moulded fixings provides rigidity & allows the system to be altered easily
- Available as either static or mobile units
 - Static - Adjustable feet allow levelling on uneven floors
 - Mobile - 50/80mm pressed steel castors
- Optional wall mounting brackets allow static units to be fixed securely to the wall, (when units are loaded over 100kg)
- Supplied for self-assembly

Dimensions (w x d x h)

Static

- Type A - 600mm Insertion
- Single Bay - 494 x 642 x 1940mm
 - Double Bay - 937 x 642 x 1940mm

- Type B - 400mm Insertion
- Single Bay - 694 x 442 x 1940mm
 - Double Bay - 1337 x 442 x 1940mm

Mobile

- Type A - 600mm Insertion
- Single Bay - 494 x 642 x 1996mm
 - Double Bay - 937 x 642 x 1996mm

- Type B - 400mm Insertion
- Single Bay - 694 x 442 x 1996mm
 - Double Bay - 1337 x 442 x 1996mm

Standard Colours

- Uprights & Cross Members - Anodised Aluminium
- Plastic Mouldings - Green/Grey

Options

- 2HH-7532293 - Wall Mounting Bracket
- 2HH-7532277 - 10mm Plastic Cover Cap

Static - Adjustable Feet

Item	Description	Weight
Type A - 600mm Insertion		
4HH-HTM71/S1/600	Static, Single Bay, 600mm Insertion	10.3kg
4HH-HTM71/S2/600	Static, Double Bay, 600mm Insertion	16.1kg
Type B - 400mm Insertion		
4HH-HTM71/S1/400	Static, Single Bay, 400mm Insertion	10.2kg
4HH-HTM71/S2/400	Static, Double Bay, 400mm Insertion	16.3kg



4HH-HTM71/S2/600
Runners, trays, baskets, dividers
not included (order separately)



4HH-HTM71/M52/400
Runners, trays, baskets, dividers
not included (order separately)

Mobile - 50mm Castors

Item	Description	Weight
Type A - 600mm Insertion		
4HH-HTM71/M51/600	Mobile, Single Bay, 600mm Insertion	11.1kg
4HH-HTM71/M52/600	Mobile, Double Bay, 600mm Insertion	17.3kg
Type B - 400mm Insertion		
4HH-HTM71/M51/400	Mobile, Single Bay, 400mm Insertion	11.0kg
4HH-HTM71/M52/400	Mobile, Double Bay, 400mm Insertion	17.5kg



4HH-HTM71/M51/600
Runners, trays, baskets, dividers
not included (order separately)

Trays & Baskets

Type D - Size 300 x 400mm

Item	Description
	Tray - ABS, 50mm Dimensions (w x d x h): 300 x 400 x 50mm Material: ABS Grey
2HH-7014050	
	Basket - ABS, 100mm Dimensions (w x d x h): 300 x 400 x 100mm Material: ABS Grey
2HH-7014100	
	Basket - ABS, 200mm Dimensions (w x d x h): 300 x 400 x 200mm Material: ABS Grey
2HH-7014200	
	Tray/Lid - ABS, 15mm Dimensions (w x d x h): 600 x 400 x 15mm Material: Plastic Grey
2HH-K561039D	





Type A & B - Size 600 x 400mm

Item	Description
	Tray - ABS, 50mm Dimensions (w x d x h): 600 x 400 x 50mm Material: ABS Grey
2HH-7011050	
	Tray - ABS, 100mm Dimensions (w x d x h): 600 x 400 x 100mm Material: ABS Grey
2HH-7011100	
	Basket - ABS, 100mm Dimensions (w x d x h): 600 x 400 x 100mm Material: ABS Grey
2HH-7012100	
	Basket - ABS, 200mm Dimensions (w x d x h): 600 x 400 x 200mm Material: ABS Grey
2HH-7012200	
	Tray/Lid - ABS, 15mm Dimensions (w x d x h): 600 x 400 x 15mm Material: Plastic Grey
2HH-K561039D	

Dividers



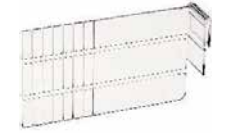







Type D - Size 300 x 400mm

Item	Description	Tray/Basket Compatibility
	Divider - PC Dimensions (w x h): 300 x 50mm Material: Polycarbonate, Transparent	2HH-7014050
2HH-7810103		
	Divider - PC Dimensions (w x h): 400 x 50mm Material: Polycarbonate, Transparent	2HH-7014050 2HH-7011050
2HH-7810102		
	Divider - ABS Dimensions (w x h): 300 x 100mm Material: ABS Grey	2HH-7014100
2HH-7811206N		
	Divider - ABS Dimensions (w x h): 400 x 100mm Material: ABS Grey	2HH-7014100 2HH-7012100
2HH-7811205N		
	Divider - ABS Dimensions (w x h): 300 x 200mm Material: ABS Grey	2HH-7014200
2HH-7811306		

Item	Description	Tray/Basket Compatibility
	Divider - ABS Dimensions (w x h): 400 x 200mm Material: ABS Grey	2HH-7014200 2HH-7012200
2HH-7811305		
	Sliding Divider - SAN Dimensions (w x h): 170 x 45mm Material: Plastic, Transparent	2HH-7014050 2HH-7011050
2HH-241302		
	Sliding Divider - SAN (including cardholder) Dimensions (w x h): 170 x 45mm Material: Plastic, Transparent	2HH-7014050 2HH-7011050
2HH-241301		
	Sliding Divider - SAN Dimensions (w x h): 170 x 100mm Material: Plastic, Transparent	2HH-7014100
2HH-240820		
	Sliding Divider - SAN (including cardholder) Dimensions (w x h): 170 x 100mm Material: Plastic, Transparent	2HH-7014100
2HH-240821		

Dividers

Type A & B - Size - 600 x 400mm

Item	Description	Tray/Basket Compatibility	Item	Description	Tray/Basket Compatibility
 2HH-7810105	Divider - ABS Dimensions (w x h): 400 x 50mm Material: ABS Grey	2HH-7014050 2HH-7011050	 2HH-7811304	Divider - ABS, Dimensions (w x h): 600 x 200mm Material: ABS Grey	2HH-7012200
 2HH-7810104	Divider - ABS Dimensions (w x h): 600 x 50mm Material: ABS Grey	2HH-7011050	 2HH-241302	Sliding Divider - SAN, Dimensions (w x h): 170 x 45mm Material: Plastic, Transparent	2HH-7014050 2HH-7011050
 2HH-7811205N	Divider - ABS Dimensions (w x h): 400 x 100mm Material: ABS Grey	2HH-7011100 2HH-7012100	 2HH-241301	Sliding Divider - SAN (including cardholder) Dimensions (w x h): 170 x 45mm Material: Plastic, Transparent	2HH-7014050 2HH-7011050
 2HH-7811204N	Divider - ABS Dimensions (w x h): 600 x 100mm Material: ABS Grey	2HH-7011100 2HH-7012100	 2HH-240820	Sliding Divider - SAN Dimensions (w x h): 170 x 100mm Material: Plastic, Transparent	2HH-7011100 2HH-7012100
 2HH-7811305	Divider - ABS Dimensions (w x h): 400 x 200mm Material: ABS Grey	2HH-7014200 2HH-7012200	 2HH-240821	Sliding Divider - SAN (including cardholder) Dimensions (w x h): 170 x 100mm Material: Plastic, Transparent	2HH-7011100 2HH-7012100

Accessories

Item	Description	Tray/Basket Compatibility
 2HH-240501	T/Clip	All Trays & Baskets
 2HH-7910204N	Safety Stop - Long (Scan Modul Compatible) Material: Plastic	All Trays & Baskets
 2HH-7910201N	Safety Stop - Short (H+H System Compatible) Material: Plastic	All Trays & Baskets
 2HH-100072	Label Holder Credit Card Size: (85 x 54mm) Material: Plastic	All Trays & Baskets
 2HH-K100187	Label Credit Card Size: (85 x 54mm) Material: Plastic, White	All Trays & Baskets

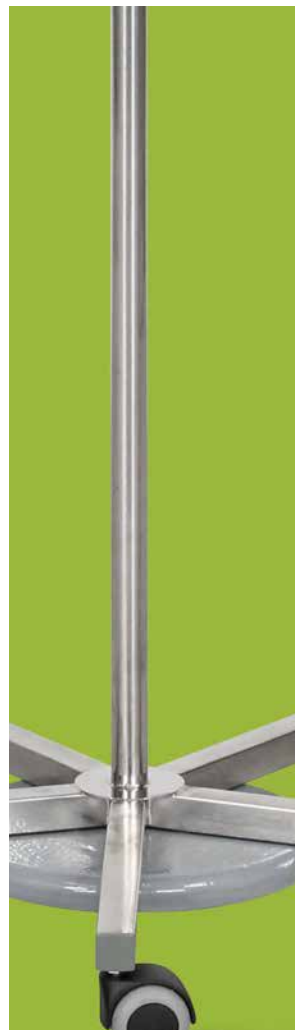

Infusion Stands & Accessories

Mobile Pump Stands	208
Mobile Infusion Stands	210
Clamping Infusion Stands	215
Wall Mounted Infusion Holders	215



HEIGHT
ADJUSTABLE

EPS005

Mobile Pump Stands - Heavy Duty, Easy Clean

Features

- Range of stands designed specifically to hold blood warmers, pumps & syringe drivers
- Fully welded heavy duty five leg base with low centre of gravity to assist stability
- 32mm diameter 304 grade stainless steel upright & 25mm diameter pump support bows
- Polyurethane overmoulded base with smooth edges & contours provides...
 - Water-resistant finish, allowing for easy & effective cleaning (including steam cleaning)
 - Shield for the twin-wheel castors
 - Impact protection to patients & staff, reducing the risk of skin abrasions & bruising
 - Protection to the fabric of the building
- Height adjustable upright using a handwheel (1300 - 2000mm)
- Available with four/six U shaped hooks
- Maximum recommended load...
 - Hooks - 12kg per stand plus
 - Fixed Upright/s - 22kg per stand
- 75mm polypropylene/thermoplastic rubber twin-wheel castors (1 x anti-static)

Dimensions (w x d x h)

- 620 x 620 x 1300-2000mm

Vertical Clamping Area

- EPS005 - 975mm
- EPS010 & EPS015 - 771mm (upright) 2 x 646mm (support bows)

Standard Colours

- Base - Grey
- Upright & Support Bows - Stainless Steel



Smooth edges & contours, allows easy & effective cleaning

Item	Description	Weight
EPS005	Mobile Pump Stand - Heavy Duty, Easy Clean, Standard Capacity, Four Hook	11.0kg
EPS010	Mobile Pump Stand - Heavy Duty, Easy Clean, High Capacity, Four Hook	13.0kg
EPS015	Mobile Pump Stand - Heavy Duty, Easy Clean, High Capacity, Six Hook	13.1kg

eClean™



Four or six U shaped hooks



Height adjustable upright using a heavy duty handwheel



EPS010
(pumps not included)



EPS015
(pumps not included)



Mobile Infusion Stands - Polyurethane, Easy Clean

Features

- Meets appendix A (Stability Requirements) of BS 3619:1976 Mobile Infusion Stands
- Five leg base with low centre of gravity to assist stability
- 25mm diameter 304 grade stainless steel upright
- Polyurethane overmoulded base with smooth edges & contours provides...
 - Water-resistant finish, allowing for easy & effective cleaning (including steam cleaning)
 - Shield for the twin-wheel castors
 - Impact protection to patients & staff, reducing the risk of skin abrasions & bruising
 - Protection to the fabric of the building
- Coloured indicator caps provide department identification & segregation, reducing the risk of cross contamination
- Height adjustable upright using a handwheel (1260 - 2100mm)
- Available with two/four pigtail hooks
- Maximum recommended load...
 - Hooks - 4kg per stand
 - Fixed Upright - 4kg per stand
- Optional handle keeps feet clear of the base, whilst also assisting manoeuvrability & improving patient safety
- 50mm polypropylene/thermoplastic rubber twin-wheel non-marking castors (1 x anti-static)

Dimensions (w x d x h)

- 620 x 620 x 1260 - 2100mm

Vertical Clamping Area

- IS/P/2H & IS/P/4H - 970mm
- IS/P/2H/H & IS/P/4H/H - 840mm

Standard Colours

- Base - Grey
- Upright & Handle - Stainless Steel
- Coloured Indicator Cap - Spearmint

Options

- Coloured Indicator Cap - Blue / Green / Red / Yellow



4 hook pole supplied with models with '4H' product code suffix

Spearmint	Blue	Green	Red	Yellow	Description	Weight
IS/P/2H/SP	IS/P/2H/BL	IS/P/2H/GR	IS/P/2H/RD	IS/P/2H/YE	Two Hook	7.8kg
IS/P/4H/SP	IS/P/4H/BL	IS/P/4H/GR	IS/P/4H/RD	IS/P/4H/YE	Four Hook	7.9kg
IS/P/2H/H/SP	IS/P/2H/H/BL	IS/P/2H/H/GR	IS/P/2H/H/RD	IS/P/2H/H/YE	Two Hook, Handle	8.2kg
IS/P/4H/H/SP	IS/P/4H/H/BL	IS/P/4H/H/GR	IS/P/4H/H/RD	IS/P/4H/H/YE	Four Hook, Handle	8.3kg



eClean™



Mobile Infusion Stands - Stainless Steel

Features

- Meets appendix A (Stability Requirements) of BS 3619:1976 Mobile Infusion Stands
- Seamless welded 304 grade stainless steel construction
- Height adjustable upright using a handwheel (1270 - 2000mm)
- Available with two or four pigtail hooks
- 9kg plastic coated weighted base available for additional stability
- Maximum recommended load...
 - Hooks - 4kg per stand plus
 - Fixed Upright
 - Non-Weighted Base - 2kg per stand
 - Weighted Base - 4kg per stand
- 50mm polypropylene/thermoplastic rubber twin wheel castors (1 x anti-static)

Dimensions (w x d x h)

- 650 x 650 x 1270-2000mm

Standard Colours

- Base/Upright - Stainless Steel
- Weighted Base - Grey



4 hook pole supplied with models with '4H' product code suffix

Item	Description	Weight
DPWS/1	Two Hook	3.8kg
DPWS/1/4H	Four Hook	3.9kg
DPWS/1/W9	Two Hook, Weighted Base	12.8kg
DPWS/1/W9/4H	Four Hook, Weighted Base	12.9kg

Mobile Infusion Stands - Mild Steel

Features

- Meets appendix A (Stability Requirements) of BS 3619:1976 Mobile Infusion Stands
- Welded mild steel construction
- Height adjustable upright using a handwheel (1270 - 2000mm)
- Available with two or four pigtail hooks
- 9kg plastic coated weighted base available for additional stability
- Maximum recommended load...
 - Hooks - 4kg per stand plus
 - Fixed Upright
 - Non-Weighted Base - 2kg per stand
 - Weighted Base - 4kg per stand
- 50mm polypropylene/thermoplastic rubber twin wheel castors (1 x anti-static)

Dimensions (w x d x h)

- 650 x 650 x 1270-2000mm

Standard Colours

- Paint - White
- Weighted Base - Grey



4 hook pole supplied with models with '4H' product code suffix

Item	Description	Weight
DPWM/1	Two Hook	3.8kg
DPWM/1/4H	Four Hook	3.9kg
DPWM/1/W9	Two Hook, Weighted Base	12.8kg
DPWM/1/W9/4H	Four Hook, Weighted Base	12.9kg



Mobile Infusion Stands - Knockdown

Features

- Meets appendix A (Stability Requirements) of BS 3619:1976 Mobile Infusion Stands
- 304 grade stainless steel legs & upright with a plastic centre boss
- Unique design allows for assembly using an Allen key to locate & hold the legs & upright in position
- Supplied boxed for self-assembly
- Height adjustable upright using a handwheel (1270 - 2000mm)
- Available with two or four pigtail hooks
- Maximum recommended load on hooks 4kg (attachment of blood warmers, pumps & syringe drivers is not recommended)
- 50mm polypropylene twin-wheel castors (1 x anti-static)

Dimensions (w x d x h)

- 650 x 650 x 1270-2000mm

Standard Colours

- Legs & Upright - Stainless Steel
- Centre Boss - Grey



Item	Description	Weight
DPKS/1	Mobile Infusion Stand - Knockdown, Two Hook	3.8kg
DPKS/1/4H	Mobile Infusion Stand - Knockdown, Four Hook	3.9kg

Infusion Poles - Replacement

Features

- Two & four pigtail hook stainless steel infusion poles
- Compatible with our drip stands (19mm diameter upright)
- Pole length 1200mm

Standard Colours

- Stainless Steel



Item	Description	Weight
DP/2H	Two Hook Infusion Pole	0.6kg
DP/4H	Four Hook Infusion Pole	0.8kg

Clamping Infusion Stands - Trolley

Features

- Clamp secures to 25mm vertical round tube (designed to fit our range of dressing trolleys)
- When fitting to other trolleys, we strongly recommend that a risk assessment is carried out to assess stability
- When fitted protrudes 45mm
- Supplied with a two pigtail hook infusion pole
- Maximum load on hooks 2kg

Dimensions (w x d x h)

- 55 x 220 x 1200mm



Item	Description	Weight
DP/C	Clamping Infusion Stands - Trolley	1.8kg

Wall Mounted Infusion Holders

Features

- Wall mounted infusion bag holder
- Available with one/two U shaped hooks
- 25mm diameter "D" shaped tube to accept pumps (max load 10kg)
- Maximum load per hook 2kg
- Fixings not included

Dimensions (w x d x h)

- IV001 - 344 x 75 x 500mm
- IV002 - 344 x 75 x 570mm



Item	Description	Weight
IV001	One Hook, Wall Mounted Infusion Holder	1.2kg
IV002	Two Hook, Wall Mounted Infusion Holder	1.6kg

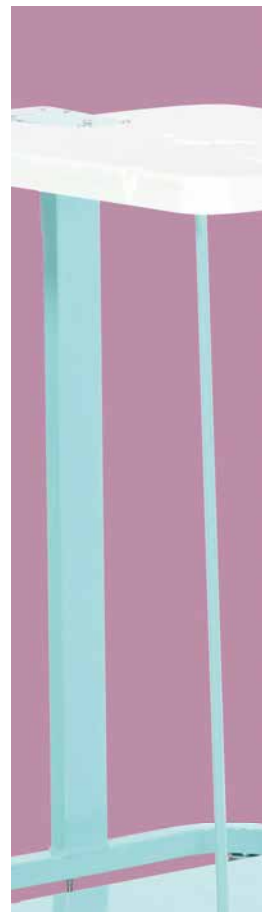

Linen Trolleys & Bags

Soiled Linen Trolleys	218
Linen Trolleys	222
Hamper Trolleys	223
Soiled Linen Bags	223
Clean Linen Trolleys	224

Soiled Linen Trolleys - Stainless Steel, Cantilever Frame



WT/6/SS



WT/6/2/SS



WT/6/PL/SS



WT/6/2/PL/SS

Features

- Seamlessly welded from from 304 grade stainless steel for strength & ease of cleaning
- Suitable for use with fabric linen bags using a tubular C shaped ring*
- Bags supported on an easy clean solid base
- Available with a plastic, pedal operated lid, when depressed prevents the trolley from moving
- 75mm pressed steel castors

*Recommended minimum bag circumference 1360mm, height 750mm

Dimensions (w x d x h)

- Single - 440 x 460 x 820mm
- Double - 835 x 460 x 820mm
- Single, Pedal Operated - 440 x 560 x 830mm
- Double, Pedal Operated - 835 x 560 x 830mm

Options

Linen Bags:

- R/BAG/WHITE - White
- R/BAG/BLUE - Blue
- R/BAG/RED - Red
- R/BAG/GREEN - Green
- R/BAG/YELLOW - Yellow
- R/BAG/GREY - Grey
- R/BAG/ORANGE - Orange

See Page 223
For Linen Bags



Pedal operated lid

Item	Description	Weight
WT/6/SS	Stainless Steel Cantilever, Single	6.5kg
WT/6/2/SS	Stainless Steel Cantilever, Double	10.0kg
WT/6/PL/SS	Stainless Steel Cantilever, Single, Pedal Operated	8.5kg
WT/6/2/PL/SS	Stainless Steel Cantilever, Double, Pedal Operated	14.5kg

Soiled Linen Trolleys - Mild Steel, Cantilever Frame

Features

- Welded mild steel frame
- Suitable for use with fabric linen bags using a tubular C shaped ring*
- Bags supported on an easy clean solid base
- Available with a plastic, pedal operated lid, when depressed prevents the trolley from moving
- 75mm pressed steel castors

*Recommended minimum bag circumference 1360mm, height 750mm

Dimensions (w x d x h)

- Single - 440 x 460 x 820mm
- Double - 835 x 460 x 820mm
- Single, Pedal Operated - 440 x 560 x 830mm
- Double, Pedal Operated - 835 x 560 x 830mm

Standard Colours

- Paint - Spearmint

Options

Linen Bags:

- R/BAG/WHITE - White
- R/BAG/BLUE - Blue
- R/BAG/RED - Red
- R/BAG/GREEN - Green
- R/BAG/YELLOW - Yellow
- R/BAG/GREY - Grey
- R/BAG/ORANGE - Orange

See Page 223
For Linen Bags

Item	Description	Weight
WT/6/MS	Mild Steel Cantilever, Single	6.5kg
WT/6/2/MS	Mild Steel Cantilever, Double	10.0kg
WT/6/PL/MS	Mild Steel Cantilever, Single, Pedal Operated	8.5kg
WT/6/2/PL/MS	Mild Steel Cantilever, Double, Pedal Operated	14.5kg



WT/6/MS



WT/6/2/MS



WT/6/PL/MS



WT/6/2/PL/MS



WT/9/MS



WT/9/2/MS



WT/9/PL/MS



WT/9/2/PL/MS

Soiled Linen Trolleys - Mild Steel, Sprung Frame

Features

- Welded mild steel frame
- Suitable for use with either fabric or disposable polythene bags using a sprung rod frame*
- Bags supported on an easy clean solid base
- Available with a plastic, pedal operated lid, when depressed prevents the trolley from moving
- 75mm pressed steel castors

*Factory set for standard 1360mm circumference bags. Can be manually adjusted to suit other bags. Recommended minimum bag height 750mm

Dimensions (w x d x h)

- Single - 440 x 460 x 825mm
- Double - 835 x 460 x 825mm
- Single, Pedal Operated - 440 x 560 x 830mm
- Double, Pedal Operated - 835 x 560 x 830mm

Standard Colours

- Paint - Spearmint

Options

- Linen Bags:
 - R/BAG/WHITE - White
 - R/BAG/BLUE - Blue
 - R/BAG/RED - Red
 - R/BAG/GREEN - Green
 - R/BAG/YELLOW - Yellow
 - R/BAG/GREY - Grey
 - R/BAG/ORANGE - Orange

Item	Description	Weight
WT/9/MS	Mild Steel, Sprung Frame, Single	6.5kg
WT/9/PL/MS	Mild Steel, Sprung Frame, Single, Pedal Operated	8.5kg
WT/9/2/MS	Mild Steel, Sprung Frame, Double	10.0kg
WT/9/2/PL/MS	Mild Steel, Sprung Frame, Double, Pedal Operated	14.5kg

See Page 223
For Linen Bags

Soiled Linen Trolleys Stainless & Mild Steel, Three Castor

Features

- Stainless or mild steel construction
 - Stainless Steel (304 Grade) - Seamlessly welded for strength & ease of cleaning
 - Mild Steel - Welded & painted
- Suitable for use with fabric linen bags using a tubular C shaped ring*
- Bag supported on a base frame
- 100mm pressed steel castors

*Recommended minimum bag circumference 1360mm, height 750mm

Dimensions (w x d x h)

- 500 x 425 x 890mm

Standard Colours

- Stainless Steel
- Paint - Spearmint

Options

- Linen Bags:
 - R/BAG/WHITE - White
 - R/BAG/BLUE - Blue
 - R/BAG/RED - Red
 - R/BAG/GREEN - Green
 - R/BAG/YELLOW - Yellow
 - R/BAG/GREY - Grey
 - R/BAG/ORANGE - Orange

See Page 223
For Linen Bags



WT/10/SS

WT/10/MS/ZP005

Item	Description	Weight
WT/10/SS	Stainless Steel, Three Castor	5.5kg
WT/10/SS/ZP005	Stainless Steel, Three Castor, Ring Buffers	6.0kg
WT/10/MS	Mild Steel, Three Castor	5.5kg
WT/10/MS/ZP005	Mild Steel, Three Castor, Ring Buffers	6.0kg

Soiled Linen Trolleys Stainless & Mild Steel, Four Castor

Features

- Stainless or mild steel construction
 - Stainless Steel (304 Grade) - Seamlessly welded for strength & ease of cleaning
 - Mild Steel - Welded & painted
- Suitable for use with fabric linen bags using a tubular C shaped ring*
- Bag supported on a base frame
- 100mm pressed steel castors

*Recommended minimum bag circumference 1360mm, height 750mm

Dimensions (w x d x h)

- Single - 460 x 460 x 890mm
- Double - 840 x 460 x 890mm

Standard Colours

- Stainless Steel
- Paint - Spearmint

Options

- ZP005 - 100mm Ring Buffers
- Linen Bags:
 - R/BAG/WHITE - White
 - R/BAG/BLUE - Blue
 - R/BAG/RED - Red
 - R/BAG/GREEN - Green
 - R/BAG/YELLOW - Yellow
 - R/BAG/GREY - Grey
 - R/BAG/ORANGE - Orange



WT/15/SS

WT/14/MS

See Page 223
For Linen Bags

Item	Description	Weight
Single		
WT/14/SS	Stainless Steel, Four Castor, Single	7.0kg
WT/14/MS	Mild Steel, Four Castor, Single	7.0kg
Double		
WT/15/SS	Stainless Steel, Four Castor, Double	8.0kg
WT/15/MS	Mild Steel, Four Castor, Double	8.0kg

Soiled Linen Trolley - Mild Steel, Folding

Features

- Folds to minimize space
 - Suitable for use with fabric linen bags
 - 50mm polypropylene/thermoplastic rubber twin-wheel castors
- *Recommended minimum bag circumference 1360mm, height 750mm

Dimensions (w x d x h)

- Overall Dimensions - 430 x 430 x 1030mm
- Folded - 430 x 200 x 1040mm

Standard Colours

- Paint - Grey

Options

- Linen Bags:
 - R/BAG/WHITE - White
 - R/BAG/BLUE - Blue
 - R/BAG/RED - Red
 - R/BAG/GREEN - Green
 - R/BAG/YELLOW - Yellow
 - R/BAG/GREY - Grey
 - R/BAG/ORANGE - Orange



WT/7/MS

See Page 223
For Linen Bags

Item	Description	Weight
WT/7/MS	Folding, Mild Steel	3.25kg

Linen Trolley - Bed Changing

Features

- Welded mild steel frame
- Three removable, sunken, liquid retaining trays
- Tray heights - 230, 590 & 960mm
- Dividing panel separates clean & soiled linen
- Suitable for use with fabric linen bags using a tubular C shaped ring*
- Bag supported on a base frame
- 100mm pressed steel castors

*Recommended minimum bag circumference 1360mm, height 750mm

Dimensions (w x d x h)

- Overall Dimensions - 830 x 490 x 1040mm
- Tray - 390 x 400 x 25mm

Standard Colours

- Paint - Grey

Options

- ZP005 - 100mm Ring Buffers
- Linen Bags:
 - R/BAG/WHITE - White
 - R/BAG/BLUE - Blue
 - R/BAG/RED - Red
 - R/BAG/GREEN - Green
 - R/BAG/YELLOW - Yellow
 - R/BAG/GREY - Grey
 - R/BAG/ORANGE - Orange



WT/13/MS

See Page 223
For Linen Bags

Item	Description	Weight
WT/13/MS	Bed Changing	15.5kg

Hamper Trolleys - Stainless & Mild Steel

Features

- Stainless or mild steel construction
 - Stainless Steel (304 Grade) - Seamlessly welded for strength & ease of cleaning
 - Mild Steel - Welded & painted
- Suitable for use with fabric hamper bags supported on 4 hooks
- Bag supported on an easy clean solid base
- 100mm pressed steel castors

Dimensions (w x d x h)

- 815 x 514 x 1000mm

Standard Colours

- Stainless Steel
- Paint - Spearmint

Options

- ZP005 - 100mm Ring Buffers
- 2FACO013 - Hamper Bag (190 litre)



WT/11/SS



WT/11/MS
(shown with optional hamper bag)

Item	Description	Weight
WT/11/SS	Hamper Trolley, Stainless Steel	12.5kg
WT/11/MS	Hamper Trolley, Mild Steel	12.5kg

Soiled Linen Bags

Features

- Washable 7oz polyester soiled linen bag
- Circumference 1360mm, height 750mm, 120 litres
- Fitted with eyelets and draw cord with plastic toggle
- Available in a range of colours to allow compliance with local, national & international guidelines



R/BAG/WHITE

R/BAG/BLUE

R/BAG/RED

R/BAG/GREEN



R/BAG/YELLOW

R/BAG/GREY

R/BAG/ORANGE

Item	Description	Weight
R/BAG/WHITE	White Linen Bag	0.3kg
R/BAG/BLUE	Blue Linen Bag	0.3kg
R/BAG/RED	Red Linen Bag	0.3kg
R/BAG/GREEN	Green Linen Bag	0.3kg
R/BAG/YELLOW	Yellow Linen Bag	0.3kg
R/BAG/GREY	Grey Linen Bag	0.3kg
R/BAG/ORANGE	Orange Linen Bag	0.3kg



WT/42



WT/42/COVER

Clean Linen Trolleys - Small (390 Litre)

Features

- Suitable for ward clean linen storage
- Mild steel frame
- Lightweight aluminium cladding & shelves
- Powder coated for durability
- Two adjustable shelves plus base (max 45kg per shelf)
 - Shelf size - 1000 x 450mm (w x d)
- Push handles at either end of trolley
- Available with a flexible cover or fold back doors, preventing dust ingress
 - Flexible Cover
 - Fire retardant cover
 - Secured to the top of the trolley & drops down to enclose the front
 - Weighted bottom hem
 - Velcro style side fastenings
 - Fold Back Doors
 - Fold back doors encloses the front
 - When opened, doors fold against the push handles at either end of the trolley
 - Secured with a drop over latch, complete with clasp to allow locking with a padlock (not supplied)
 - Drop down bolt secures base of doors
- 125mm pressed steel castors
- Maximum capacity 135kg per trolley

Dimensions (w x d x h)

- Overall Dimensions - 1175 x 530 x 1065mm
- Internal Dimensions - 1000 x 500 x 810mm

Standard Colours

- Paint - Grey

Options

- C008 - 125mm Castors, Heavy Duty Pressed Steel, 2 x Braking, 2 x Non-Braking (set of 4)
- ZP010 - 100mm Ring Buffers

Item	Description	Weight
WT/42	Clean Linen Trolley - Small	39.7kg
WT/42/COVER	Clean Linen Trolley - Small, Flexible Cover	42.4kg
WT/42/FBD	Clean Linen Trolley - Small, Fold Back Doors	46.0kg

Clean Linen Trolleys - Medium (690 Litre)

Features

- Widely used for bulk linen delivery, part of a linen exchange system, or as an alternative to dedicated ward linen rooms
- Mild steel frame
- Lightweight aluminium cladding & shelves
- Powder coated for durability
- Three adjustable shelves plus base (max 45kg per shelf)
 - Shelf size - 1180 x 460mm (w x d)
- Inset push handles at either end of trolley
- Low level bumper rail offers protection to both the trolley & fabric of the building
- Available with a flexible cover or fold back doors, preventing dust ingress
 - Flexible Cover
 - Fire retardant cover
 - Secured to the top of the trolley & drops down to enclose the front
 - Weighted bottom hem
 - Velcro style side fastenings
 - Fold Back Doors
 - Fold back doors encloses the front
 - When opened, doors fold back flat at either end of the trolley*
 - Secured with a drop over latch, complete with clasp to allow locking with a padlock (not supplied)
 - Drop down bolt secures base of doors
- Optional tow bar fitting
 - Tow bar fitted to the front (swivel castor)
 - Antiluce fastener fitted to rear (fixed castor)
 - Tow bar position approx. 360-380mm above floor
 - Recommended max speed 7kph for towed trolleys
- 200mm heavy duty castors, 2 x fixed, 2 x swivel
- Maximum capacity 180kg per trolley

*Doors will not fold back flat when a tow bar is fitted

Dimensions (w x d x h)

- Overall Dimensions - 1430 x 600 x 1495
- Internal Dimensions - 1180 x 500 x 1180

Standard Colours

- Paint - Grey

Item	Description	Weight
Non-Towing		
WT/50	Clean Linen Trolley - Medium	87.0kg
WT/50/COVER	Clean Linen Trolley - Medium, Flexible Cover	90.0kg
WT/50/FBD	Clean Linen Trolley - Medium, Fold Back Doors	97.3kg
Towing		
WT/50/TBAR	Clean Linen Trolley - Medium, Tow Bar	89.5kg
WT/50/COVER/TBAR	Clean Linen Trolley - Medium, Flexible Cover, Tow Bar	92.5kg
WT/50/FBD/TBAR	Clean Linen Trolley - Medium, Fold Back Doors, Tow Bar	100.8kg



Tow Bar



WT/50



WT/50/FBD

AGV Compatible Trolleys & Carts
 Bristol Maid™ is your ideal partner for transport trolleys & carts for Automated Guided Vehicle (AGV) systems. We can provide solutions that are compatible with Sterile Supplies, Laundry, Medical Records & Pharmacy distribution



WT/48

AGV Compatible Trolleys & Carts

Bristol Maid™ is your ideal partner for transport trolleys & carts for Automated Guided Vehicle (AGV) systems. We can provide solutions that are compatible with Sterile Supplies, Laundry, Medical Records & Pharmacy distribution

Clean Linen Trolleys - Large (1100 Litre)

Features

- Widely used for bulk linen delivery, part of a linen exchange system, or as an alternative to dedicated ward linen rooms
- Mild steel frame
- Lightweight aluminium cladding & shelves
- Powder coated for durability
- Three adjustable shelves plus base (max 45kg per shelf)
 - Shelf size - 1430 x 555mm (w x d)
- Inset push handles at either end of trolley
- Low level bumper rail offers protection to both the trolley & fabric of the building
- Available with a flexible cover or fold back doors, preventing dust ingress
 - Flexible Cover
 - Fold Back Doors
- Optional tow bar fitting
- 200mm heavy duty castors, 2 x fixed, 2 x swivel
- Maximum capacity 180kg per trolley

Dimensions (w x d x h)

- Overall Dimensions - 1710 x 700 x 1620mm
- Internal Dimensions - 1420 x 610 x 1295mm

Standard Colours

- Paint - Grey

Item	Description	Weight
Non-Towing		
WT/48	Clean Linen Trolley - Large	99.6kg
WT/48/COVER	Clean Linen Trolley - Large, Flexible Cover	102.9kg
WT/48/FBD	Clean Linen Trolley - Large, Fold Back Doors	111.5kg
Towing		
WT/48/TBAR	Clean Linen Trolley - Large, Tow Bar	103.1kg
WT/48/COVER/TBAR	Clean Linen Trolley - Large, Flexible Cover, Tow Bar	106.4kg
WT/48/FBD/TBAR	Clean Linen Trolley - Large, Fold Back Doors, Tow Bar	115.0kg



WT/50/WT/COVER

WT/48/FBD

Flexible Cover

- Fire retardant cover
- Secured to the top of the trolley & drops down to enclose the front
- Weighted bottom hem
- Velcro style side fastenings

Tow Bar Fitting

- Tow bar fitted to the front (swivel castor)
- Antiluce fastener fitted to rear (fixed castor)
- Tow bar position approx. 360-380mm above floor
- Recommended max speed 7kph for towed trolleys

Fold Back Doors

- Fold back doors, encloses the front
- When opened, doors fold back flat at either end of the trolley*
- Secured with a drop over latch, complete with clasp to allow locking with a padlock (not supplied)
- Drop down bolt secures base of doors

*Doors will not fold back flat when a tow bar is fitted

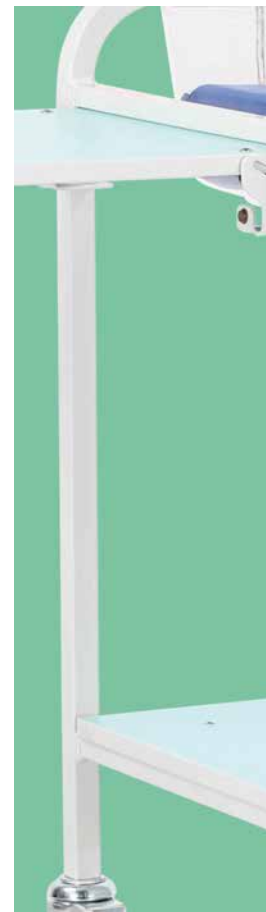

Maternity Equipment

Variable Height Baby Cribs	230
Fixed Height Baby Cribs	232
Variable Height Baby Bath	233



BA/VH



Rechargeable battery located at rear of crib



Supplied with a handset



Alternative Colours
Page 410

Baby Cribs - Variable Height, Battery Operation

Features

- EN 60601-1:2006+A12:2014 Medical electrical equipment. General requirements for basic safety and essential performance
- Rechargeable battery powered height adjustment
- Height adjustment from 700-910mm
- Crib can be tilted at either end, horizontal to approx 6 degrees
- Two push handles
- Lower cupboard with fixed shelf
- Two lift up work flaps (max capacity 2.0kg)
- Supplied with a clear plastic crib (PETG) & flame retardant mattress (max capacity 6.0kg)
- Supplied with one rechargeable battery & handset*
- 100mm pressed steel braking castors

*Battery has to be removed from the unit for charging (see options for additional batteries)

Dimensions (w x d x h)

- Overall Dimensions - 940 x 510 x 700-910mm
- Mattress - 600 x 330 x 60mm
- Cupboard - 210 x 265 x 315mm (internal, either side of the column)
- Work Flap - 415 x 305mm

Standard Colours

- Paint - Spearmint
- Cabinet/Lower Shelf/Work Flaps- Spearmint/Grey

Options

- 2LIDE033 - Additional Rechargeable Battery
- 2LIDE037 - Charger for Rechargeable Battery
- 2PLCO014 - Clear Plastic Crib, Solid Side (Spare/Replacement)
- 2FACO052 - Mattress, Flame Retardant, Washable (Spare/Replacement)

Item	Description	Weight
BA/VH	Battery Operated, With Charger	49.5kg
BA/VH/NC	Battery Operated, Without Charger	49.5kg

Baby Crib - Variable Height, Gas Strut Operation

Features

- Gas damper powered height adjustment
- Height adjustment from 710-1025mm
- Crib can be tilted at either end, horizontal to approx 6 degrees
- Two push handles
- Supplied with a clear plastic crib (PETG) & flame retardant mattress (max capacity 6.0kg)
- 75mm twin-wheel braking castors

Dimensions (w x d x h)

- Overall Dimensions - 930 x 476 x 775-1025mm
- Mattress - 600 x 330 x 60mm

Standard Colours

- Paint - Spearmint/Grey

Options

- BA902 - Slide Out Debris Bin
- BA903 - Wire Basket
- BA904 - Lift Up Flap
- 2PLCO014 - Clear Plastic Crib, Solid Side (Spare/Replacement)
- 2FACO052 - Mattress, Flame Retardant, Washable (Spare/Replacement)



Alternative Colours
Page 410



BA903 - Wire Basket

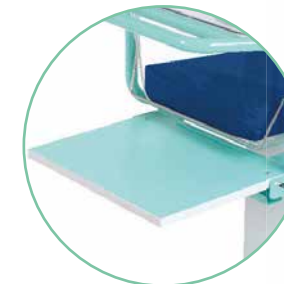

BA904 - Lift Up Flap

Item	Description	Weight
BA030	Variable Height, Gas Strut Operation	20.2kg



BA030



BA/3/B



BA/6



BA/6/A



Baby Cribs - Fixed Height

Features

- Constructed from melamine faced chipboard & laminate
- Available with...
 - Lower shelf
 - Lower shelf & small cupboard (with adjustable shelf)
 - Large cupboard (with adjustable shelf)
- Crib can be tilted at either end, horizontal to approx 6 degrees
- Two lift up work flaps (max capacity 2.0kg)
- Supplied with a clear plastic crib (PETG) & flame retardant mattress (max capacity 6.0kg)
- 100mm pressed steel castors, 2 off braking

Dimensions (w x d x h)

- Overall Dimensions - 952 x 500 x 929mm
- Mattress - 600 x 330 x 60mm
- Large Base Shelf - 810 x 400mm at height 270mm (BA/3/B)
- Small Base Shelf - 460 x 355mm at height 270mm (BA/6)
- Small Cupboard - 355 x 420 x 345mm (internal) at height 270mm (BA/6)
- Large Cupboard - 710 x 420 x 345mm (internal) at height 270mm (BA/6/A)
- Work Flap - 415 x 305mm

Standard Colours

- Paint - Grey
- Cabinet/Lower Shelf/Work Flaps - Spearmint/Grey

Options

- 2PLCO014 - Clear Plastic Crib, Solid Side (Spare/Replacement)
- 2FACO052 - Mattress, Flame Retardant, Washable (Spare/Replacement)

Item	Description	Weight
BA/3/B	Fixed Height, Lower Shelf	23.5kg
BA/6	Fixed Height, Small Cupboard	34.0kg
BA/6/A	Fixed Height, Large Cupboard	42.0kg

Baby Bath - Variable Height, Gas Strut Operation

Features

- Gas damper powered height adjustment
- Height adjustment from 720-970mm
- Supplied with a plastic bath (max capacity 20.0kg)
- 75mm twin-wheel braking castors

Dimensions (w x d x h)

- 930 x 476 x 720-970mm

Standard Colours

- Paint - Spearmint/Grey
- Laminate - Spearmint

Options

- BA900 - Wire Basket
- BA901 - Lift Up Flap
- 2PLCO013 - Baby Bath (Spare/Replacement)



BA900 - Wire Basket

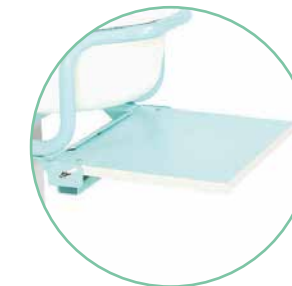

BA901 - Lift Up Flap



BA015

Item	Description	Weight
BA015	Variable Height, Gas Strut Operation	16.2kg

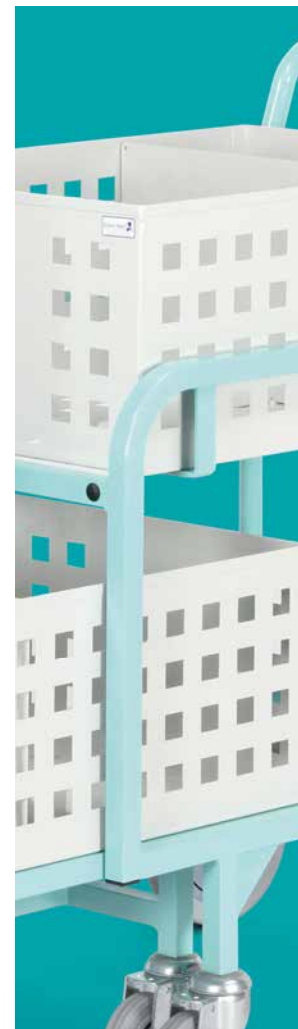

Medical Records

Medical Records Trolleys	236
Medical Record Workstations	242
Laptop/Motion C5 Holders	244
Carefile Filing Pockets	246
CLIQ® & RFID Solutions	247
Medical Record Filing Trolleys	248
Medical Records Transfer Trolleys	249
Medical Records Cabinet	251



MR200

Medical Records Trolleys - Small

Features

- Suitable for use with our popular narrow & wide filing pockets (order separately)
- Available as open or with a locking lid...
 - Open sides, lower shelf & work flap
 - Locking lid & lower shelf
- Locking lid fitted with either a...
 - CAM lock (supplied with 2 keys)
 - Electronic push button lock
- Maximum load on lid 2.0kg
- Document pocket fitted to end of trolley
- Optional ring buffers to protect the fabric of the building (increases length & width of trolley by approx. 80mm)
- 100mm pressed steel castors

Standard Colours

- Paint - Spearmint/Grey
- Lids/Flaps - Spearmint

Options

- ZP010 - Ring Buffers
- CF/F/PK10 - Narrow Foolsap Filing Pockets (x 10)
- CF/X/PK10 - Narrow X-Ray Filing Pockets (x 10)
- CF/XF/PK10 - Narrow X-Ray/Foolsap Filing Pockets (x 10)
- CF/WF/PK10 - Wide Foolsap Filing Pockets (x 10)
- R/C/T - Paper Tabs (x 500)
- R/C/TH - Tab Holders (x 25)
- C004 - 100mm Polymer Castor, 2 x Braking / 2 x Non-Braking (set of 4)
- C005 - 100mm Polymer Castor, 4 x Braking (set of 4)

Filing Capacity

Item	Standard
Narrow Pockets	470mm
Wide Pockets	380mm

*When fully open trolley length is approximately 1190mm

Item	Description	Overall Dimensions (w x d x h)	Weight
MR200	Open Sides, Lower Shelf & Work Flap	627 x 522 x 997mm	18.0kg
MR210*	Locking Lid & Lower Shelf, CAM Lock	671 x 522 x 1056mm	27.2kg
MR210CL*	Locking Lid & Lower Shelf, Electronic Push Button Lock	671 x 522 x 1056mm	27.2kg



MR210CL



Alternative colours
Page 410

Carefile Pocket Compatibility

Item	Narrow		Wide	
	CF/F/PK10	CF/X/PK10	CF/XF/PK10	CF/WF/PK10
MR200	✓	✓	✓	✓
MR210	✓	✓	✓	✓
MR210CL	✓	✓	✓	✓



Electronic Push Button Lock

- Uses a 10-button keypad & a # button. The # button is hidden beneath the handle when in the locked position
- Easy programming & code change
- Four operating codes with differing levels of authority - Master / Sub-master / User / Technician
- User codes are 4 digits
- Master & sub-master codes are 8 digits
- 15,000 openings on 2 x AAA cells (supplied)
- Low battery warning with failure override using 9v battery across LED's (+/-) & master code



MR300

Medical Records Trolleys - Medium

Features

- Suitable for use with our popular narrow filing pockets (order separately)
- Available as open or with locking lids...
 - Open sides, lower shelf & work flap
 - Locking lids & lower shelf
- Locking lids fitted with either a...
 - CAM lock (supplied with 2 keys)
 - Electronic push button lock
- Maximum load on lid 2.0kg
- Document pocket fitted to end of trolley
- Optional ring buffers to protect the fabric of the building (increases length & width of trolley by approx. 80mm)
- 100mm pressed steel castors

Standard Colours

- Paint - Spearmint/Grey
- Lids/Flaps - Spearmint

Options

- ZP010 - Ring Buffers
- CF/F/PK10 - Narrow Foolscap Filing Pockets (x 10)
- CF/X/PK10 - Narrow X-Ray Filing Pockets (x 10)
- CF/XF/PK10 - Narrow X-Ray/Foolscap Filing Pockets (x 10)
- R/C/T - Paper Tabs (x 500)
- R/C/TH - Tab Holders (x 25)
- C004 - 100mm Polymer Castor, 2 x Braking / 2 x Non-Braking (set of 4)
- C005 - 100mm Polymer Castor, 4 x Braking (set of 4)

Filing Capacity

Item	Standard
Narrow Pockets	695mm

*When fully open trolley length is approximately 1420mm

Item	Description	Overall Dimensions (w x d x h)	Weight
MR300	Open Sides, Lower Shelf & Work Flap	851 x 522 x 997mm	20.8kg
MR310*	Locking Lids & Lower Shelf, CAM Lock	920 x 522 x 1056mm	34.4kg
MR310CL*	Locking Lids & Lower Shelf, Electronic Push Button Lock	920 x 522 x 1056mm	34.4kg



MR310CL



Alternative colours
Page 410

Carefile Pocket Compatibility

Item	Narrow			Wide
	CF/F/PK10	CF/X/PK10	CF/XF/PK10	CF/WF/PK10
MR300	✓	✓	✓	✗
MR310	✓	✓	✓	✗
MR310CL	✓	✓	✓	✗



Electronic Push Button Lock

- Uses a 10-button keypad & a # button. The # button is hidden beneath the handle when in the locked position
- Easy programming & code change
- Four operating codes with differing levels of authority - Master / Sub-master / User / Technician
- User codes are 4 digits
- Master & sub-master codes are 8 digits
- 15,000 openings on 2 x AAA cells (supplied)
- Low battery warning with failure override using 9v battery across LED's (+/-) & master code



MR400

Medical Records Trolleys - Large

Features

- Suitable for use with our popular narrow & wide filing pockets (order separately)
- Available as open or with locking lids...
 - Open sides, lower shelf & work flap
 - Locking lids & lower shelf
- Locking lids fitted with either a...
 - CAM lock (supplied with 2 keys)
 - Electronic push button lock
- Maximum load on lid 2.0kg
- Document pocket fitted to end/side of trolley
- Optional ring buffers to protect the fabric of the building (increases length & width of trolley by approx. 80mm)
- 100mm pressed steel castors

Standard Colours

- Paint - Spearmint/Grey
- Lids/Flaps - Spearmint

Options

- ZP010 - Ring Buffers
- CF/F/PK10 - Narrow Foolsap Filing Pockets (x 10)
- CF/X/PK10 - Narrow X-Ray Filing Pockets (x 10)
- CF/XF/PK10 - Narrow X-Ray/Foolsap Filing Pockets (x 10)
- CF/WF/PK10 - Wide Foolsap Filing Pockets (x 10)
- R/C/T - Paper Tabs (x 500)
- R/C/TH - Tab Holders (x 25)
- C004 - 100mm Polymer Castor, 2 x Braking / 2 x Non-Braking (set of 4)
- C005 - 100mm Polymer Castor, 4 x Braking (set of 4)

Filing Capacity

Item	Standard
Narrow Pockets	940mm
Wide Pockets	760mm

*When fully open trolley length is approximately 2085mm

Item	Description	Overall Dimensions (w x d x h)	Weight
MR400	Open Sides, Lower Shelf & Work Flap	1158 x 584 x 997mm	28.0kg
MR410*	Locking Lids & Lower Shelf, CAM Lock	1240 x 522 x 1056mm	46.4kg
MR410CL*	Locking Lids & Lower Shelf, Electronic Push Button Lock	1240 x 522 x 1056mm	46.4kg



MR410CL



Alternative colours
Page 410

Carefile Pocket Compatibility

Item	Narrow		Wide	
	CF/F/PK10	CF/X/PK10	CF/XF/PK10	CF/WF/PK10
MR400	✓	✓	✓	✓
MR410	✓	✓	✓	✓
MR410CL	✓	✓	✓	✓



Electronic Push Button Lock

- Uses a 10-button keypad & a # button. The # button is hidden beneath the handle when in the locked position
- Easy programming & code change
- Four operating codes with differing levels of authority - Master / Sub-master / User / Technician
- User codes are 4 digits
- Master & sub-master codes are 8 digits
- 15,000 openings on 2 x AAA cells (supplied)
- Low battery warning with failure override using 9v battery across LED's (+/-) & master code



MRW/S1DXP/CAM

MRW/S2D/CAM
fitted with MRW/LHR/S
(laptop not included)

MRW/S1DOC/CAM

Medical Records Workstations

Features

- Constructed from melamine faced chipboard / laminate offering an extremely strong & durable, yet aesthetically pleasing appearance
- Available as single & double column units with...
 - One / two drawers & x-ray pigeon hole (5 / 10 sections)
 - One / two drawers & open cupboard
 - Two / four drawers
- Two locking options
 - CAM lock (supplied with 2 keys)
 - Electronic push button lock
- Where relevant one lock secures all drawers
- Double drawer units fitted with an anti-tilt mechanism preventing two drawers from being opened at the same time
- Max load per drawer 16.0kg
- Push handle & document pocket fitted to end of trolley
- Suitable for use with our filing pockets (order separately)
- Provides 375mm filing capacity per drawer
- Polyurethane ring buffers offer protection to both the trolley & fabric of the building; smooth surfaces assist cleaning
- 100mm pressed steel castors, 2 off braking

Dimensions (w x d x h)

- Single Column - 604 x 538 x 1028mm
- Double Column - 1056 x 538 x 1034mm

Standard Colours

- Paint - Grey White
- Base / Sides / Back / Centre Panels - Grey White
- Top / Drawer Fronts - Spearmint
- Edging - Grey White

Electronic Push Button Lock



- Uses a 10-button keypad & a # button. The # button is hidden beneath the handle when in the locked position
- Easy programming & code change
- Four operating codes with differing levels of authority - Master / Sub-master / User / Technician
- User codes are 4 digits
- Master & sub-master codes are 8 digits
- 15,000 openings on 2 x AAA cells (supplied)
- Low battery warning with failure override using 9v battery across LED's (+/-) & master code

Single Column

CAM Lock	Electronic Push Button Lock	Description	Weight
MRW/S1DXP/CAM	MRW/S1DXP/CL	One Drawer, X-Ray Pigeon Hole	34.2kg
MRW/S1DOC/CAM	MRW/S1DOC/CL	One Drawer, Open Cupboard	34.0kg
MRW/S2D/CAM	MRW/S2D/CL	Two Drawers	40.6kg



MRW/D2DXP/CAM

MRW/D2DOC/CL

Options

- MRW/LHR/S - Laptop Holder, Removable, Swing Arm
- MRW/LHNR/S - Laptop Holder, Non-Removable, Swing Arm
- MRW/LH/C5 - Motion C5 Holder, Swing Arm
- CF/F/PK10 - Narrow Foolscap Filing Pockets (x 10)
- R/C/T - Paper Tabs (x 500)
- R/C/TH - Tab Holders (x 25)
- C004 - 100mm Polymer Castor, 2 x Braking / 2 x Non-Braking (set of 4)
- C005 - 100mm Polymer Castor, 4 x Braking (set of 4)

Double Column

CAM Lock	Electronic Push Button Lock	Description	Weight
MRW/D2DXP/CAM	MRW/D2DXP/CL	Two Drawers, X-Ray Pigeon Hole	62.0kg
MRW/D2DOC/CAM	MRW/D2DOC/CL	Two Drawers, Open Cupboard	58.0kg
MRW/D4D/CAM	MRW/D4D/CL	Four Drawers	72.0kg



MRW/D4D/CAM



Laptop Holder - Removable, Swing Arm

Features

- Three section swing arm offering height, rotation & angle adjustment
- Compatible with the MRW range of medical record workstations
- Laptop holder fitted to an upright bolted to the rear left hand corner of the trolley (upright & holder supplied for customer to fit)
- Adjustable to accept laptops 280-435 x 22mm (w x h)
- Maximum capacity 2.0kg
- Laptop supported in a cradle fitted with adjustable wing arms
- Laptop can be secured using a security clamp (supplied)*
- Design allows easy access to laptop ports

*Not compatible with the Dell laptops using the N17 wedge lock system

Standard Colours

- Paint - Grey White

Item	Description	Weight
MRW/LHR/S	Removable, Swing Arm	3.7kg

Laptop Holder - Non-Removable, Swing Arm

Features

- Three section swing arm offering height, rotation & angle adjustment
- Compatible with the MRW range of medical record workstations
- Laptop holder fitted to an upright bolted to the rear left hand corner of the trolley (upright & holder supplied for customer to fit)
- Adjustable to accept laptops 280-435 x 22mm (w x h)
- Maximum capacity 2.0kg
- Laptop supported in a cradle fitted with a steel mounting bracket that can be fixed using either nyloc or wing nuts
- Laptop can be secured using a security clamp (supplied)*
- Design allows easy access to laptop ports

*Not compatible with the Dell laptops using the N17 wedge lock system

Standard Colours

- Paint - Grey White

Item	Description	Weight
MRW/LHNR/S	Non-Removable, Swing Arm	5.0kg



MRW/S2D/CAM fitted with MRW/LHR/S (laptop not included)

Laptop Holder - Motion C5 Holder

Features

- Three section swing arm offering height, rotation & angle adjustment
- Compatible with the MRW range of medical record workstations
- Motion C5 holder fitted to an upright bolted to the rear left hand corner of the trolley (upright & holder supplied for customer to fit)
- Maximum capacity 2.0kg
- Tablet located in a RAM-In-Motion passive dock allowing for easy insertion & removal

Standard Colours

- Paint - Grey White



Item	Description	Weight
MRW/LH/C5	Motion C5 Holder - Swing Arm	2.7kg

Laptop supported in a cradle fitted with a steel mounting bracket that can be fixed using either nyloc or wing nuts





Carefile Filing Pockets

Features

- Filing pockets suitable with Bristol Maid™ trolleys and most standard filing suspension systems
- Provides a durable alternative to paper or card types in narrow and wide versions
 - Narrow - 380mm spacings/centres
 - Wide - 470mm spacings/centres
- Fire retardant PVC coated nylon fabric with stainless steel runners
- Unique 'stay-put' tab holders and pink / blue reversible card tabs
- Supplied in packs of ten

Standard Colours

- Vinyl - Grey

Item	Description	Internal Pocket Dimensions (w x h)
Narrow Pockets		
CF/F/PK10	Foolscap (x 10)	360 x 260mm
CF/X/PK10	X-Ray (x 10)	360 x 460mm
CF/XF/PK10	X-Ray/Foolscap (x 10)	X-ray - 360 x 460mm Foolscap - 360 x 260mm
Wide Pockets		
CF/WF/PK10	Wide Foolscap (x 10)	450 x 260mm
Paper Tabs & Tab Holders		
R/C/T	Paper Tabs (x 500)	
R/C/TH	Tab Holders (x 25)	

CLIQ® & RFID Solutions

The use of CLIQ® coupled with unique RFID tag identifiers allows a single key to be used with Medicines Management and for Accessing Patient Records.

- Controlled Drug Cabinets (audit trail available)
- Drug & Medicine Cabinets (audit trail available)
- Self-Administration Cabinets
- Bedside Cabinets
- Drug & Medicine Dispensing Trolleys
- Medical Records Trolleys

The use of RFID cards allows a single card to be used with Self-Administration Schemes.

- Self-Administration Cabinets
- Bedside Cabinets

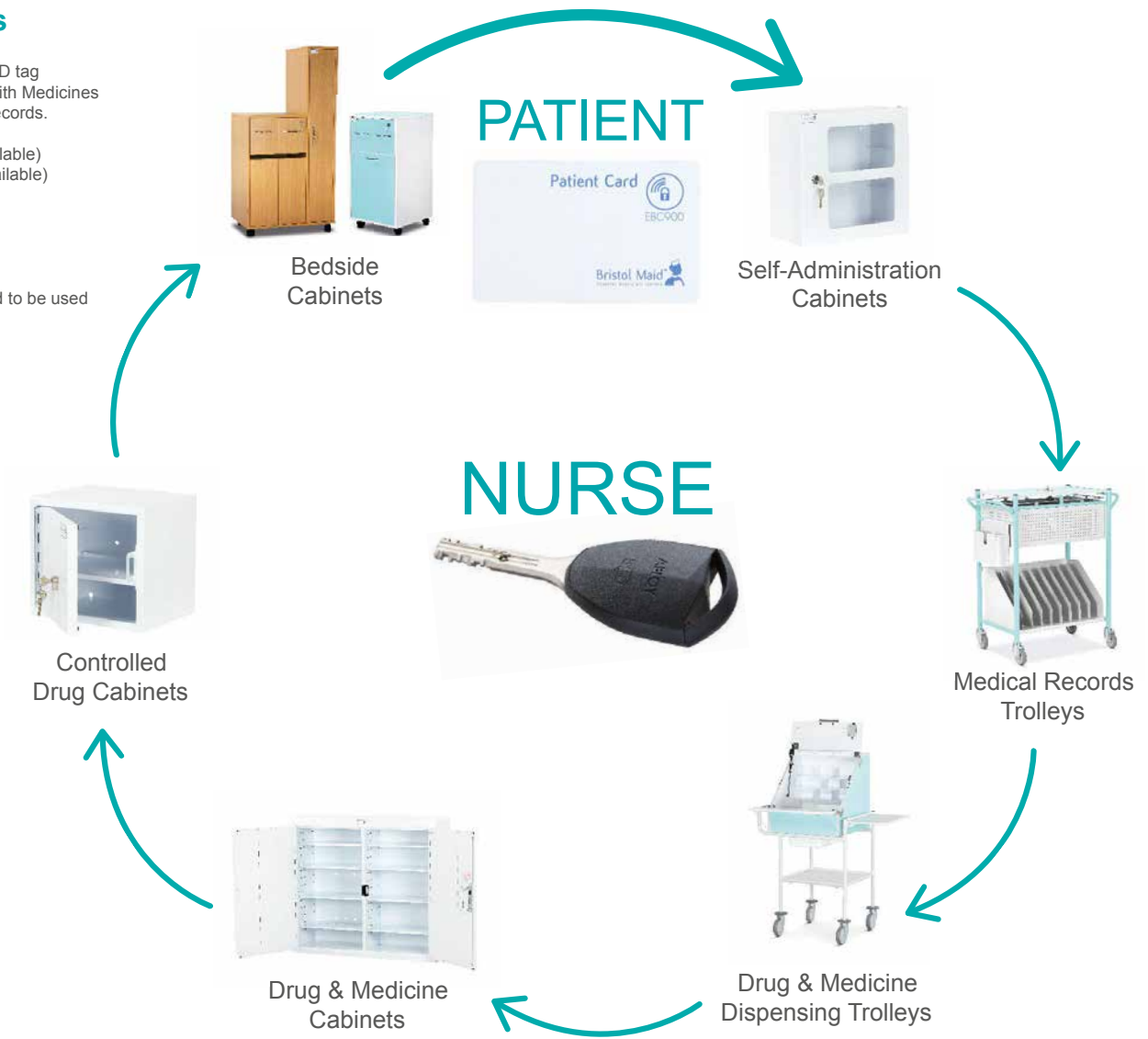



MRF/S/OC

MRF/LD/CL

	Case Note Files	Ring Binders	Lever Arch Files
	235 x 50 x 320mm	250 x 40 x 315mm	290 x 75 x 315mm
Small - 900mm	18	22	12
Large - 1800mm	36	44	24

Medical Record Filing Trolleys - Tiered

Features

- Suitable for use with ring binders, case note & lever arch files (max file height 350mm)
- Available in two sizes with either an open front or locking door/s
 - Small - 900mm filing capacity
 - Large - 1800mm filing capacity
- Trolleys supplied with adjustable dividers (small 4 / large 8)
- Doors fold against the sides of the trolley (not flat)
- Large trolleys use one lock to secure both doors
- Two locking options
 - CAM lock (supplied with 2 keys)
 - Electronic push button lock
- Optional polyurethane ring buffers offer protection to both the trolley & fabric of the building; smooth surfaces assist cleaning, (increases length & width of trolley by approx. 80mm)
- 100mm pressed steel castors

Dimensions (w x d x h)

- Single Column - 604 x 538 x 1028mm
- Double Column - 1056 x 538 x 1034mm

Standard Colours

- Paint - Spearmint/Grey
- Top - Spearmint
- Edging - Grey
- Door/s - Grey

Options

- C004 - 100mm Polymer Castor, 2 x Braking / 2 x Non-Braking (set of 4)
- C005 - 100mm Polymer Castor, 4 x Braking (set of 4)
- C006 - 100mm Polymer Castor, 4 x Non-Braking (set of 4)
- ZP010 - Ring Buffers (set of 4)
- MRF/LHR/S - Laptop Holder - Removable, Swing Arm
- MRF/LHNR/S - Laptop Holder - Non-Removable, Swing Arm
- MRF/LH/C5 - Motion C5 Holder - Swing Arm

Item	Description	Weight
Small		
MRF/S/OC	Small - Open Cupboard	21.5kg
MRF/S/LD/CAM	Small - Locking Door, CAM Lock with Wing Handle	26.5kg
MRF/S/LD/CL	Small - Locking Door, Electronic Push Button Lock	26.5kg
Large		
MRF/L/OC	Large - Open Cupboard	30.0kg
MRF/L/LD/CAM	Large - Locking Doors, CAM Lock with Wing Handle	41.0kg
MRF/L/LD/CL	Large - Locking Doors, Electronic Push Button Lock	41.0kg



Alternative Colours
Page 410



Electronic Push Button Lock

- Uses a 10-button keypad & a # button. The # button is hidden beneath the handle when in the locked position
- Easy programming & code change
- Four operating codes with differing levels of authority - Master / Sub-master / User / Technician
- User codes are 4 digits
- Master & sub-master codes are 8 digits
- 15,000 openings on 2 x AAA cells (supplied)
- Low battery warning with failure override using 9v battery across LED's (+/-) & master code

Medical Records Transfer Trolleys - Single Box

Features

- Suitable for use the transportation of bulk case notes & X-rays
- Records stored in an upper box - internal dimensions 600 x 450 x 250mm (bottom of box positioned 520mm to floor)
- Lower tray
- Available with a locking lid fitted with either a CAM or electronic push button lock providing secure storage patient records
- Trolley max capacity 50kg
- Optional ring buffers to protect the fabric of the building (increases length & width of trolley by approx. 80mm)
- 100mm pressed steel castors

Dimensions (w x d x h)

- 817 x 523 x 975mm

Standard Colours

- Paint - Spearmint/Grey

Options

- ZP005 - Ring Buffers



MR130



MR140

Item	Description	Weight
Open		
MR130	Open Top	16.0kg
Locking Lid		
MR140	Locking Lid, CAM Lock	19.0kg
MR140CL	Locking Lid, Electronic Push Button Lock	19.0kg



Electronic Push Button Lock

- Uses a 10-button keypad & a # button. The # button is hidden beneath the handle when in the locked position
- Easy programming & code change
- Four operating codes with differing levels of authority - Master / Sub-master / User / Technician
- User codes are 4 digits
- Master & sub-master codes are 8 digits
- 15,000 openings on 2 x AAA cells (supplied)
- Low battery warning with failure override using 9v battery across LED's (+/-) & master code



Alternative Colours
Page 410

Medical Records Transfer Trolley Double Box

Features

- Trolley for the transportation of bulk case notes & x-rays
- Records stored in two removable boxes - internal dimensions 535 x 344 x 290mm
 - Lower - Top of box 440mm to floor
 - Upper - Top of box 975mm to floor
- Clearance between upper & lower boxes, 235mm
- Max capacity 25kg (per box)
- Optional ring buffers to protect the fabric of the building (increases length & width of trolley by approx. 80mm)
- 100mm pressed steel castors

Dimensions (w x d x h)

- 940 x 425 x 1040mm

Standard Colours

- Paint - Spearmint

Options

- ZP005 - Ring Buffers
- 2PLCO327 - Removable Box



Item	Description	Weight
MR105	Double Box	24.0kg

Medical Records Transfer Trolley Double Box, Extending

Features

- Trolley for the transportation of bulk case notes & x-rays
- Records stored in two removable boxes - internal dimensions 568 x 368 x 316mm
 - Lower - Top of box 440mm to floor
 - Upper - Top of box 975mm to floor
- Clearance between upper & lower boxes, 235mm
- Max capacity 25kg (per box)
- 100mm pressed steel castors

Dimensions (w x d x h)

- 875 x 598 x 1040mm

Options

- 2PLCO271 - Removable Box

Standard Colours

- Paint - Spearmint



Item	Description	Weight
MR110	Double Box, Extending	31.6kg

Medical Records Transfer Trolley Double Box, Duo

Features

- Unique 'two' trolley system for the bulk transportation of case notes & x-rays
- Records stored in fixed boxes - internal dimensions 600 x 420 x 255mm
- Allows trolleys to be loaded independently, before being linked together & transported
- Trolleys link together using a simple clevis pin
- Max capacity 25kg (per box)
- 100mm pressed steel castors (2 off braking) & 200mm wheels (braking)

Dimensions (w x d x h)

- 866 x 522 x 970mm

Standard Colours

- Paint - Spearmint/Grey



Item	Description	Weight
MR120	Double Box, Duo	34.6kg



Medical Records Cabinet X-Ray Filing

Features

- Lockable x-ray filing cabinet (complete with dividers)
 - Three drawers fitted with heavy duty ball bearing slides
 - Anti-tilt device prevents more than one drawer being opened at the same time
 - Offers total filing capacity of 1740mm, 580mm per drawer*
- *Suspended filing is not compatible with this unit

Dimensions (w x d x h)

- 590 x 660 x 1320mm

Standard Colours

- Paint - Grey



Item	Description	Weight
5AM3XRAY	X-Ray Filing Cabinet	75.0kg



Phlebotomy

Caretray Trolley - Phlebotomy 254
Phlebotomy Chairs 256



CTPHLEM1/10/3S2D

Caretray Trolley - Phlebotomy

Features

- Designed for quick & easy complete disassembly when conducting thorough or deep cleaning programmes (including steam cleaning)
- Available in mild or stainless steel (requires no on-site assembly)
 - Fully welded mild steel frame that is blast finished & powder coated in a durable epoxy paint
 - Seamlessly welded one piece frame from 304 grade stainless steel
- Ergonomic push handle fitted to one side of the trolley ensures correct posture & keeps feet away from the frame, ideal for mobile phlebotomy or in cases where the trolley is wheeled for long periods of time
- One piece moulded top with raised edges on three sides & integral rim at the front to contain any spillages (max load 30kg)
- One piece moulded side panels incorporate runners with positive stops, preventing trays from being accidentally withdrawn
- Carerails fitted to each side of the trolley to support a wide range of accessories (see options)
- Trolley pre-configured with the following accessories...
 - Single Sharps Box Holder - Accepts sharps boxes up to seven litres capacity. Sharps box secured using a rubber band fitted with a toggle
 - Alcohol Gel Holder - Accepts bottles with maximum 90 x 90mm square base
 - Single Glove / Mask Box Holder - Accommodates glove & mask boxes up to 150mm in width
 - Debris Bin & Bracket - Plastic debris bin & bracket (internal dims 200 x 135 x 100mm)
- 100/150mm deep translucent high impact plastic trays feature an integral handle with plastic clip on label cover, (max load per tray 5kg)
- Each trolley is supplied with perforated coloured label strips (white, blue, green, yellow & red)
- Trays can be subdivided in both length & width using simple slot in dividers (each tray supplied with 2 x long & 2 x short dividers)
- Polyurethane ring buffers offer protection to both the trolley & fabric of the building; smooth surfaces assist cleaning
- 100mm polymer castors offering smooth surfaces to assist cleaning, 2 off braking

Dimensions (w x d x h)

- Overall Dimensions - 610 x 550 x 993mm
- Plastic Top - Single Column - 455 x 455 (internal) at height 968mm
- Shallow Tray - 355 x 405 x 100mm (internal)
- Deep Tray - 355 x 405 x 150mm (internal)

Mild Steel

Item	Description	Weight
CTPHLEM1/10/3S2D	3 x 100mm, 2 x 150mm Trays	28.1kg
CTPHLEM1/10/4S1D	4 x 100mm, 1 x 150mm Trays	27.8kg
CTPHLEM1/10/6S	6 x 100mm Trays	28.9kg

Standard Colours

- Paint - Spearmint



CTPHLES1/10/3S2D/CTD1/10CA

Stainless Steel

Item	Description	Weight
CTPHLES1/10/3S2D	3 x 100mm, 2 x 150mm Trays	28.1kg
CTPHLES1/10/4S1D	4 x 100mm, 1 x 150mm Trays	27.8kg
CTPHLES1/10/6S	6 x 100mm Trays	28.9kg

Options

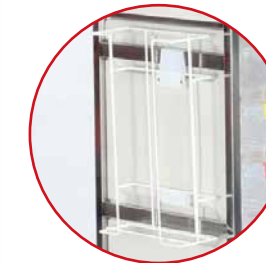

DG/3/15
Triple Glove Box Holder



CT/PARM
Phlebotomy Armrest



CT/WF
Work Flap



CTD1/10CA
Single Door & Back Panel
(CAM Lock with Wing Handle)



CTD1/10EPB
Single Door & Back Panel
(Electronic Push Button Lock)

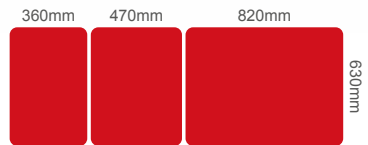

Hand Switch

Foot Switch

Alternative colours available at extra cost. Change suffix 'VBB' on the product code with any of the following i.e. Electric - Foot Switch in Graphite - EC5315/VGH

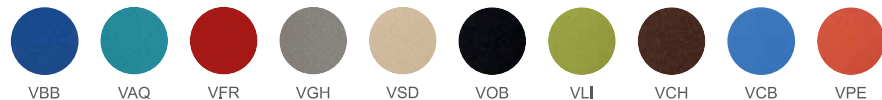

Phlebotomy Chair Variable Height

Features

- BS 2838-2: 1991 Examination & general treatment couches, build, performance & safety specifications
- EN 60601-1:2006+A12:2014 Medical electrical equipment. General requirements for basic safety & essential performance

- Electric or hydraulic height adjustment
- Height adjustment from 490-950mm
- Adjustable angle backrest
 - Manual -25 to +90 degrees
 - Electric -22 to +90 degrees
- Adjustable angle footrest from -90 to +10 degrees
- Anti-trap gas struts fitted with release levers used on the back & footrest sections (optional electric backrest)
- Retractable castors fitted to both ends to assist with movement & positioning
- One adjustable foot fitted to allow levelling on uneven floors
- Clearance beneath frame allows access for mobile hoists
- Electric models (230V ~, 50/60Hz) fitted with a UK 3 pin plug & available with a hand or foot switch
- Hydraulic models use a foot pump pedal positioned on both sides of the couch
- Seamless upholstery using flame retardant anti-microbial vinyl
- Adjustable polyurethane phlebotomy armrests
- Side support loops assist with patient mount & dismount (self-assembly)
- Paper roll holder (suitable for rolls max 510mm wide x 200mm diameter)
- Frames prepared to accept optional accessories
- Maximum capacity 225kg

Dimensions (w x d x h)

- 770 x 1710 x 490-950mm

Standard Colours

- Paint - White
- Vinyl - Bristol Blue

Options

- E06 - Battery Back Up

Item	Description	Weight
EC5305/VBB	Hydraulic	67.0kg
EC5310/VBB	Electric - Hand Switch	67.0kg
EC5315/VBB	Electric - Foot Switch	67.0kg
EC5320/VBB	Electric with Electric Backrest - Hand Switch	69.3kg
EC5325/VBB	Electric with Electric Backrest - Foot Switch	69.3kg

Phlebotomy Chair Variable Height, Bariatric

Features

- BS 2838-2: 1991 Examination & general treatment couches, build, performance & safety specifications
- EN 60601-1:2006+A12:2014 Medical electrical equipment. General requirements for basic safety & essential performance

- Electric height adjustment
- Height adjustment from 490-950mm
- Adjustable angle backrest
 - Manual -25 to +90 degrees
 - Electric -22 to +90 degrees
- Adjustable angle footrest from -90 to +10 degrees
- Anti-trap gas struts fitted with release levers used on the back & footrest sections
- Retractable castors fitted to both ends to assist with movement & positioning
- One adjustable foot fitted to allow levelling on uneven floors
- Clearance beneath frame allows access for mobile hoists
- 230V ~, 50/60Hz actuator fitted with a UK 3 pin plug & available with a hand or foot switch
- Seamless upholstery using flame retardant anti-microbial vinyl
- Adjustable polyurethane phlebotomy armrests
- Side support loops assist with patient mount & dismount (self-assembly)
- Paper roll holder (suitable for rolls max 510mm wide x 200mm diameter)
- Frames prepared to accept optional accessories
- Maximum capacity 325kg

Dimensions (w x d x h)

- 990 x 1710 x 520-950mm

Standard Colours

- Paint - White
- Vinyl - Bristol Blue

Options

- E18 - Battery Back Up

Item	Description	Weight
EC5330/VBB	Electric - Hand Switch	77.2kg
EC5335/VBB	Electric - Foot Switch	77.2kg
EC5340/VBB	Electric with Electric Backrest - Hand Switch	79.5kg
EC5345/VBB	Electric with Electric Backrest - Foot Switch	79.5kg

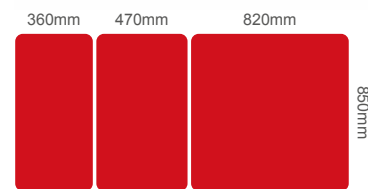

Hand Switch

Foot Switch

Alternative colours available at extra cost. Change suffix 'VBB' on the product code with any of the following i.e. Electric with Electric Backrest - Hand Switch in Onyx Black - EC5340/VOB

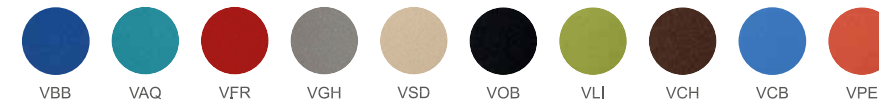

Alternative colours available at extra cost. Change suffix 'VBB' on the product code with any of the following i.e. Fixed Height Phlebotomy Chair in Aquamarine - EC5000/VAQ



EC5000/VSD



EC5000/VGH



EC5000/VFR



EC5000/VAQ



EC5000/VPE



EC5000/VCB



EC5000/VCH



EC5000/VI

Phlebotomy Chair Fixed Height



Features

- BS EN 16139: 2013 Level 2. Furniture. Strength, durability & safety. Requirements for non-domestic seating
- BS 4875: Part1: 2001 Test Level 4 (strength & durability)
- BS 7945: 1999 (stability)
- Certified for use up to 32 stone (203kg)
- Stable four leg design
- Black finish tubular frame
- Seamless upholstery using flame retardant anti-microbial vinyl
- Adjustable polyurethane phlebotomy armrest
- Armrest can be positioned on either side of the chair (additional armrest available if required)
- Maximum capacity 203kg

Dimensions (w x d x h)

- 620 x 580 x 800mm

Standard Colours

- Paint - Black
- Vinyl - Bristol Blue

Options

- E15 - Phlebotomy Armrest (Single)



EC5000/VOB/E15



EC5000/VBB

Item	Description	Seat Height	Weight
EC5000/VBB	Fixed Height	485mm	15.0kg

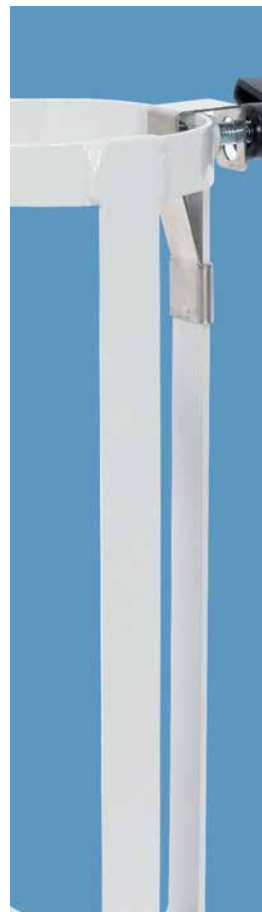

Portering Chairs

Portering Chair - Rear Steer	262
Portering Chair - Front Steer	263
Portering Chair - Bariatric, Rear Steer	265
Options	266



CE



G/200/RS/VBB

Portering Chair Rear Steer, Nesting, Sliding Foot Rest

Features

- Nests to occupy reduced floor space and encourage tidy storage
- Seamless upholstery using flame retardant antimicrobial vinyl
- Moulded drop down arm rests allows side access for patients and helpers
- Sliding rubber foot rest aids access as well as supporting feet during transit
- Design ensures chair will not tip should patient stand on the step
- X-ray/notes pocket on rear of seat
- Two hooks for patients belongings
- Fittings to accept IV poles/cylinder holders mounted to rear uprights
- 200mm fixed wheels/150mm total stop braking castors (cushioned)
- Maximum capacity 190.0kg

Dimensions (w x d x h)

- Overall Dimensions - 660 x 840 x 1040mm
- Seat - 540 x 420mm at Height 530mm
- Back - 490 x 455mm

Standard Colours

- Paint - Grey
- Upholstery - Bristol Blue

Options

- CYHP/D1 - Cylinder Holder, CD/D
- CYHP/E1 - Cylinder Holder, E
- G/CLS - Calf/Leg Supports (pair)
- G/DP - Infusion Pole
- G/SB - Lap Seatbelt, Factory Fitted
- G/CARD/LOCK - Card/Coin Lock, Factory Fitted
- G/CARD/STATION - Head of Station
- 2LOKE011 - Release Card



X-Ray/Notes Pocket

Item	Description	Weight
G/200/RS/VBB	Rear Steer, Nesting, Sliding Foot Rest	29.0kg

Alternative colours available at additional cost. Change suffix 'VBB' on the product code with any of the following i.e. Rear Steer, Nesting, Sliding Foot Rest in Bristol Blue - G/200/RS/VBB

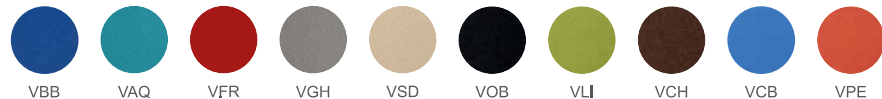

Portering Chair Front Steer, Nesting, Sliding Foot Rest

Features

- Nests to occupy reduced floor space and encourage tidy storage
- Seamless upholstery using flame retardant antimicrobial vinyl
- Moulded drop down arm rests allows side access for patients and helpers
- Sliding rubber foot rest aids access as well as supporting feet during transit
- Design ensures chair will not tip should patient stand on the step
- X-ray/notes pocket on rear of seat
- Two hooks for patients belongings
- Fittings to accept IV poles/cylinder holders mounted to rear uprights
- 125mm swivel castors/200mm braking fixed wheels (cushioned)
- Maximum capacity 190.0kg

Dimensions (w x d x h)

- Overall Dimensions - 660 x 1005 x 1090mm
- Seat - 540 x 420mm at Height 600mm
- Back - 490 x 455mm

Standard Colours

- Paint - Grey
- Upholstery - Bristol Blue

Options

- CYHP/D1 - Cylinder Holder, CD/D
- CYHP/E1 - Cylinder Holder, E
- G/CLS - Calf/Leg Supports (pair)
- G/DP - Infusion Pole
- G/SB - Lap Seatbelt, Factory Fitted
- G/CARD/LOCK - Card/Coin Lock, Factory Fitted
- G/CARD/STATION - Head of Station
- 2LOKE011 - Release Card



X-Ray/Notes Pocket

Item	Description	Weight
G/305/FS/VBB	Front Steer, Nesting, Sliding Foot Rest	29.0kg



CE



G/305/FS/VBB

Alternative colours available at additional cost. Change suffix 'VBB' on the product code with any of the following i.e. Front Steer, Nesting, Sliding Foot Rest in Lime - G/305/FS/VLI

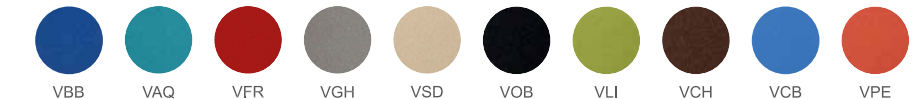



G/205/FS/VBB

Portering Chair Front Steer, Nesting, Hinged Foot Rests

Features

- Nests to occupy reduced floor space and encourage tidy storage
- Seamless upholstery using flame retardant antimicrobial vinyl
- Moulded drop down arm rests allows side access for patients and helpers
- Folding/hinging foot rests aids access as well as supporting feet during transit
- X-ray/notes pocket on rear of seat
- Two hooks for patients belongings
- Fittings to accept IV poles/cylinder holders mounted to rear uprights
- 125mm swivel castors/200mm braking fixed wheels (cushioned)
- Maximum capacity 190.0kg

Dimensions (w x d x h)

- Overall Dimensions - 660 x 710 x 1055mm
- Seat - 540 x 420mm at Height 530mm
- Back - 490 x 455mm

Standard Colours

- Paint - Grey
- Upholstery - Bristol Blue

Options

- CYHP/D1 - Cylinder Holder, CD/D
- CYHP/E1 - Cylinder Holder, E
- G/CLS - Calf/Leg Supports (pair)
- G/DP - Infusion Pole
- G/SB - Lap Seatbelt, Factory Fitted
- G/CARD/LOCK - Card/Coin Lock, Factory Fitted
- G/CARD/STATION - Head of Station
- 2LOKE011 - Release Card



X-Ray/Notes Pocket

Item	Description	Weight
G/205/FS/VBB	Front Steer, Nesting, Hinged Foot Rests	27.5kg

Alternative colours available at additional cost. Change suffix 'VBB' on the product code with any of the following i.e. Front Steer, Nesting, Hinged Foot Rests in Flame Red - G/205/FS/VFR

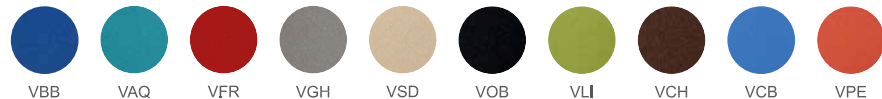

Portering Chair Bariatric, Rear Steer, Sliding Foot Rest



G/500/RS/VBB

Features

- Heavy duty bariatric portering chair
- Seamless upholstery using flame retardant antimicrobial vinyl
- Moulded drop down arm rests allows side access for patients and helpers
- Sliding rubber foot rest aids access as well as supporting feet during transit
- Design ensures chair will not tip should patient stand on the step
- X-ray/notes pocket on rear of seat
- Two hooks for patients belongings
- Fittings to accept IV poles mounted to rear uprights
- Retractable diagonal seatbelt
- 200mm fixed wheels/200mm total stop braking castors (cushioned)
- We recommend that two members of staff are in attendance when used with a patient in excess of 190kg
- Maximum capacity 380.0kg

Dimensions (w x d x h)

- Overall Dimensions - 930 x 1000 x 1090mm
- Seat - 740 x 670mm at Height 530mm
- Back - 700 x 480mm

Standard Colours

- Paint - Grey
- Upholstery - Bristol Blue

Options

- G/500/RS/CYL - Cylinder Holder, CD/D
- G/CLS/500 - Calf/Leg Supports (pair)
- G/DP - Infusion Pole
- G/CARD/LOCK - Card/Coin Lock, Factory Fitted
- G/CARD/STATION - Head of Station
- 2LOKE011 - Release Card



X-Ray/Notes Pocket

Item	Description	Weight
G/500/RS/VBB	Bariatric, Rear Steer, Sliding Foot Rest	43.8kg

Alternative colours available at additional cost. Change suffix 'VBB' on the product code with any of the following i.e. Bariatric, Rear Steer, Sliding Foot Rest in Coastal Blue - G/500/RS/VCB

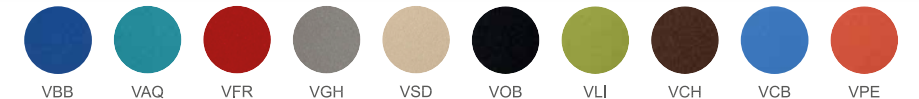

Cylinder Holders

Features

- Compatible with 100mm diameter cylinders (C/CD/D/E)
- Mounts to IV support tube at rear of chair using a handwheel
- Compatible with G/200/RS, G/205/FS, G/305/FS & G/500/RS models

Standard Colours

- Paint - Grey



Item	Description	Weight
CYHP/D1	C/CD/D Size	1.0kg
CYHP/E1	E Size	1.8kg
G/500/RS/CYL	Bariatric - C/CD/D Size	1.0kg

Calf / Leg Support - Pair

Features

- Moulded calf/leg support on captive retractable support tube
- Retracts beneath the seat when not in use
- Compatible with G/200/RS, G/205/FS, G/305/FS & G/500/RS models
- Supplied as a pair

Standard Colours

- Stainless Steel/Black



Item	Description	Weight
G/CLS	Calf/Leg Support, Pair	2.3kg
G/CLS/500	Bariatric Calf/Leg Support, Pair	2.3kg

Infusion Pole

Features

- Stainless steel infusion pole with a U shaped hook (length of pole 980mm)
- Mounts to IV support tube at rear of chair using a handwheel
- Compatible with G/200/RS, G/205/FS, G/305/FS & G/500/RS models



Item	Description	Weight
G/DP	IV Pole	1.1kg

Lap Seatbelt

Features

- Lap seat belt with snap buckle
- Compatible with G/200/RS, G/205/FS & G/305/FS models
- Factory fitted

Standard Colours

- Black



Item	Description	Weight
G/SB	Lap Seatbelt	0.4kg

Card/Coin Lock

Features

- Compatible with old & new one pound coin (euro compatible)
- Coin/card remains in the lock until the chair is connected to another chair or the head of station
- Plastic release card available for use by porters
- Factory fitted
- Compatible with G/200/RS, G/205/FS, G/305/FS & G/500/RS models
- Replacement card/coin lock cassette available (requires cassette removal tool)



Item	Description	Weight
G/CARD/LOCK	Card/Coin Lock, Factory Fitted	1.0kg
2LOKE011	Plastic Release Card	0.01kg
2LOCK217	Card/Coin Lock Cassette, New £1 Coin Compatible	0.2kg
2LOCK218	Cassette Removal Tool	0.01kg

Card/Coin Lock Wall Bracket

Features

- Head of station for chairs fitted with card/coin locks
- Requires fitting to the fabric of the building (wall fixings not supplied)
- Chain length 1000mm
- One required for each row of chairs, (G/200/RS, G/205/FS & G/305/FS)
- Compatible with G/200/RS, G/205/FS, G/305/FS & G/500/RS models



Item	Description	Weight
G/CARD/STATION	Head of Station	1.6kg

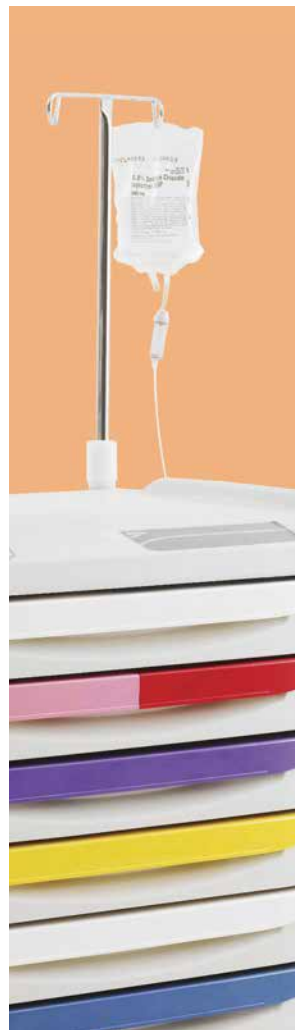

Procedure Trolleys & Carts

Plaster Trolleys	270
Mobile Workstations	271
Procedure Carts	272



WT/96/3/SS/4BK
(fitted with optional flap, louver panel & ring buffers)

Plaster Trolley - Stainless Steel

Features

- Seamlessly welded easy clean stainless steel plaster trolley (304 grade)
- Supplied with three drawers (max load 10kg per drawer)
- Integral bucket ring (supplied with a 15 litre stainless steel bucket)
- Lower shelf (max load 40kg)
- 100mm pressed steel anti-static non marking castors

Dimensions (w x d x h)

- Overall Dimensions - 1150 x 540 x 915mm
- Drawers - 650 x 410 x 100mm (internal)
- Work Surface - 745 x 515 at height 915mm
- Lower Shelf - 746 x 515 at height 175mm

Standard Colours

- Stainless

Options

- WT/96/FLAP - Lift Up Flap
- WT/96/SS/LP - Louver Panel
- 2PLCO024 - Plastic Lin Bin
- ZP010 - Ring Buffers
- 2BK - 2 x Braking Castors / 2 x Non-Braking Castors
- 4BK - 4 x Braking Castors



2PLCO024
optional lin bin

Item	Description	Weight
WT/96/3/SS	Three Drawers & Bucket	51.0kg

Mobile Workstation - Mild Steel, Low Level

Features

- Low level mobile workstation constructed from mild steel
- Recessed liquid retaining top
- Single point locking
- To maximise safety, the unit is fitted with an anti-tilt mechanism, allowing only one drawer to be opened at any one time
- Full extension drawers, heights 85, 170 & 255mm (max load 30kg per drawer)
- Two tone colour keyway, drawer fronts available in a range of colours
- Low level corner bumpers to protect the fabric of the building
- 80mm heavy duty castors, 2 off braking

Dimensions (w x d x h)

- Overall - 615 x 500 x 810mm
- Drawers - 480 x 375 x 85/170/255mm (internal)

Standard Colours

- Body - Light Grey
- Drawers - Dark Grey



Item	Description	Weight
MW005	2 x 85mm, 1 x 170mm, 1 x 255mm Drawers, Cam Lock	49.0kg



Procedure Carts - Polymer, Metro Flexline™

Features

- Range of pre-configured carts to suit a wide range of applications
- Lightweight polymer construction with smooth rounded corners to assist cleaning
- Upper work surface provides a writing surface/space for preparation work
- Three locking options (CAM/electronic locking & security seal compatible)
- Full extension lightweight polymer drawers, depths 76, 152, 229mm (max load 7-20kg per drawer (dependent on drawer size)
- Incorporates Microban offering antimicrobial protection
- Two tone colour keyway, drawer handles available in a range of colours
- 127mm castors, 2 x Directional Castors / 2 x Braking Castors

Dimensions (w x d x h)

- Drawers - 514 x 432 x 76/152/229mm (internal)

Standard Colours

- Body - Light Taupe
- Drawers Handles - Model Dependant

Options

- 8FL190 - Drawer Label Holders (x 10)



Drawer Label Holders

This is a small selection of a large configurable range. Please contact our customer services team to discuss your requirements

Item	Description	Overall Dimensions (w x d x h)	Weight
8FLCRP4	Emergency Cart - 3 x 76mm, 2 x 152mm, 1 x 229mm Drawers, Code Blue Handles, Security Seal Lock	1056 x 607 x 1273mm	91.0kg
8FLPED1	Paediatric Emergency Cart - 8 x 76mm, 1 x 152mm Drawers, Coloured Handles, Security Seal Lock	1056 x 607 x 1273mm	91.0kg
8FLTMNT2	Treatment Cart - 2 x 76mm, 2 x 152mm, 1 x 229mm Drawers, Slate Blue Handles, CAM Lock	819 x 568 x 1064mm	51.0kg
8FLCOM-LT	Laptop Cart - 1 x Keyboard Tray, 1 x 76mm, 2 x 152mm, 1 x 229mm Drawers, Slate Blue Handles, Keyless Entry Touch Pad	819 x 568 x 1064mm	83.0kg
8FLCLINE	Central Line Cart - 3 x 76mm, 2 x 152mm, 1 x 229mm Drawers, Dark Taupe Handles, Keyless Entry Touch Pad	819 x 568 x 1064mm	91.0kg
8FLCCU1	Critical Care Cart - 3 x 76mm, 2 x 152mm, 1 x 229mm Drawers, Red Handles, Keyless Entry Touch Pad	840 x 569 x 1807mm	90.0kg



Fitted To Trolley

- 76mm Drawer Divider Kit
- 152/229mm Drawer Divider Kit
- 76mm Drawer Divider Tray & Dividers
- 152mm Drawer Divider Tray & Dividers
- Side Bin, Locking
- Side Bin, Non-Locking
- Waste Basket (28 Litre)
- Oxygen Cylinder Holder
- Lockable Sharps Container
- Cord Manager
- Adjustable Defibrillator Tray
- Hospital Grade 6, Outlet Strip & Holder
- Suction Pump Shelf
- Rear Fitting Backboard
- Laptop Arm
- Pull Out Side Shelf
- Two Hook Infusion Pole
- Plastic Security Seals, (x 100)
- Drawer Seal Lock Bar
- Lock Alert VI – Auto Lock
- Overbridge with Top Shelf & Hanger Rail
- Six Compartment Tilt Bin for Overbridge

	Emergency 8FLCRP4	Paediatric Emergency 8FLPED1	Treatment 8FLTMNT2	Laptop 8FLCOM-LT	Central Line 8FLCLINE	Critical Care 8FLCCU1
76mm Drawer Divider Kit			2		2	
152/229mm Drawer Divider Kit			2		1	
76mm Drawer Divider Tray & Dividers	3					
152mm Drawer Divider Tray & Dividers	2					
Side Bin, Locking	4				2	4
Side Bin, Non-Locking				3	2	4
Waste Basket (28 Litre)					✓	
Oxygen Cylinder Holder	✓	✓				
Lockable Sharps Container					✓	
Cord Manager	✓					
Adjustable Defibrillator Tray	✓	✓				
Hospital Grade 6, Outlet Strip & Holder	✓					
Suction Pump Shelf	✓	✓				
Rear Fitting Backboard	✓	✓				
Laptop Arm				✓		
Pull Out Side Shelf	✓	✓				
Two Hook Infusion Pole	✓	✓				
Plastic Security Seals, (x 100)	✓	✓				
Drawer Seal Lock Bar		✓				
Lock Alert VI – Auto Lock				✓	✓	✓
Overbridge with Top Shelf & Hanger Rail						✓
Six Compartment Tilt Bin for Overbridge						✓



Procedure Carts - Polymer, Metro Starsys™

Features

- Range of pre-configured carts to suit a wide range of applications
- Lightweight polymer construction with smooth rounded corners to assist cleaning
- Upper work surface provides a writing surface/space for preparation work
- Five locking options, (electronic touchpad/pushbutton/keyless, CAM & security seal compatible)
- Full extension lightweight polymer drawers, depths 76, 152, 229mm (max load 7-20kg per drawer (dependent on drawer size)
- Incorporates Microban offering antimicrobial protection
- Two tone colour keyway, drawer handles available in a range of colours
- 127mm castors, 2 x Swivel Castors / 2 x Braking Castors

Standard Colours

- Body - Light Taupe
- Drawers Handles - Model Dependant

Options

- 8SXLABKIT - Drawer/Door Label Holders, (x 10)



Drawer / Door Label Holders

This is a small selection of a large configurable range. Please contact our customer services team to discuss your requirements

Item	Description	Overall Dimensions (w x d x h)	Weight
8SXRANES	Anaesthesia Cart - 4 x 152mm, 1 x 229mm Drawers, Dark Taupe Handles, CAM Lock	882 x 633 x 1136mm	104.0kg
8SXRSDRS	Dressing Cart - 3 x 76mm, 2 x 152mm, 1 x 229mm Drawers, Dark Taupe Handles, CAM Lock	577 x 633 x 1060mm	83.0kg
8SXRSTRAMA	Trauma Cart - 3 x 76mm, 4 x 152mm Drawers, Slate Blue Handles, CAM Lock	882 x 633 x 1136mm	116.0kg
8SXRSCCU	Critical Care Cart - 1 x 76mm, 1 x 152mm, 3 x 229mm Drawers, Slate Blue Handles	882 x 633 x 1212mm	107.0kg
8SXRARTH	Arthroscopic Cart - 6 x 152mm, 1 x 229mm Drawers, Dark Taupe Handles, CAM Lock	882 x 633 x 1136mm	110.0kg
8SXRIV	IV Therapy Cart - 5 x 76mm, 2 x 229mm Drawers, Green Handles, CAM Lock	882 x 633 x 1136mm	106.0kg
8XRSCAST	Cast Cart - 2 x 76mm, 2 x 152mm, 2 x 229mm Drawers, Slate Blue Handles	882 x 633 x 1212mm	109.0kg



Fitted To Trolley

76mm Drawer Divider Kit					
Left Swing Out Pod, Three Tilt Bins					
Left Swing Out Pod, Three Locking Tilt Bins (CAM Lock)					
Left Swing Out Pod, Top Locking Tilt Bin (CAM Lock)					
Pod Tray With Dividers					
Waste Basket & Holder					
Right Fixed Pod, One Tilt Bin					
Right Swing Out Pod					
Right Swing Out Pod, Three Locking Tilt Bins (CAM Lock)					
Right Swing Out Pod, Top Locking Tilt Bin (CAM Lock)					
Tilt Bin					
Middle Non Locking Tilt Bin					
Sharps Container Bracket					
Left Swing Out Locking Pod, Three Tilt Bins (CAM Lock)					
Right Swing Out Locking Pod, Three Tilt Bins (CAM Lock)					
Overbridge with One Shelf & Accessory Rail					
Overbridge with Two Accessory Rails					
Two Hook Infusion Pole					
Wire Basket					
Universal Clamp					
Laryngoscope Blade/Specimen Holder					
Half Size Utility Bin (Metal)					
Full Size Utility Bin (Metal)					
Label/Tape Dispenser (x 3)					
Plastic Utility Bins with Clear Covers (x 6)					

	Anaesthesia 8SXRANES	Trauma 8SXRSTRAMA	Critical Care 8SXRSCCU	Arthroscopic 8SXRARTH	IV Therapy 8SXRIV	Cast 8XRSCAST
		2	1		4	1
			✓			✓
					✓	
		✓		✓		
		✓	✓	✓	✓	✓
		✓	✓	✓		✓
			✓			
				✓		
		✓			✓	
		✓		✓		
	✓					
	✓					
		✓	✓			
	✓			✓		✓
		✓			✓	
	✓					
	✓		✓	✓		
	✓					
	✓					
	✓					
	✓		✓	✓		
	✓					
	✓					
	✓					
	✓					
	✓					
	✓					
	✓					
	✓		✓	✓		



Procedure Carts - Metro Basix™

Features

- Lightweight metal procedure carts
- Recessed liquid retaining plastic work surface
- Three locking options
 - CAM (Compact)
 - Push button (Trauma)
 - Security seal compatible (Anaesthesia)
- Full extension drawers, depths 76, 152 & 230mm
 - Compact - Max load 7kg per drawer
 - Trauma/Anaesthesia - Max load 24kg per drawer
- Drawer fronts available in a range of colours
- 125mm castors, total lock at front & directional lock at rear

Dimensions (w x d x h)

- Compact - 489 x 470 x 876mm
- Drawers (internal)
 - 76mm - 381 x 432 x 76mm
 - 152mm - 381 x 432 x 152mm
 - 230mm - 381 x 432 x 230mm
- Trauma/Anaesthesia Cart - 762 x 613 x 1440mm
- Drawers (internal)
 - 76mm - 432 x 565 x 76mm
 - 152mm - 432 x 565 x 152mm
 - 230mm - 432 x 565 x 230mm

Standard Colours

- Body - Light Taupe
- Drawers - Dark Blue (see below for alternative colours)

Options

- 8MBA172 - Label Holders (x 12)

Alternative drawer colours are available. Change suffix 'DB' on the product code with any of the following i.e. - Compact Basix Cart with red drawers 8MBC1210RE

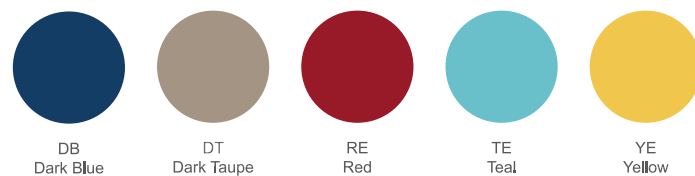

Item	Description	Weight
8MBC1210DB	Compact - 1 x 76mm, 2 x 152mm, 1 x 230mm Drawers	63.0kg
8MBX3210TRAUMADB	Trauma - 3 x 76mm, 2 x 152mm, 1 x 230mm Drawers	78.0kg
8MBX1310ANES4DB	Anaesthesia - 1 x 76mm, 3 x 152mm, 1 x 230mm Drawers	81.0kg



Label Holders



8MBC1210YE



8MBX3210TRAUMARE



8MBX1310ANES4TE



Resuscitation Trolleys & Carts

Resuscitation Trolleys	280
Caretray Trolley - Resuscitation	282
Resuscitation Carts - Polymer	284
Airways / Difficult Intubation Trolley	287



WT210



WT200



WT250/CYL/D/E shown with optional cylinder holder WT/CYL/D/E

Resuscitation Trolleys - Mild Steel

Features

- Popular resuscitation trolley
- Drawer contents are secured when the lower cupboard is closed (security seal compatible)
- Upper drawer supplied with a plastic drawer liner, with dividers
- Recessed liquid retaining stainless steel work surface (usable 630 x 445)
- Lift up work flap (usable 305 x 455mm)
- Two hook infusion pole mounted to rear of trolley
- Low level bumper bar
- Push handles one end
- 125mm pressed steel castors

Dimensions (w x d x h)

- Drawers (internal)
 - 70mm - 600 x 430 x 70mm
 - 96mm - 600 x 430 x 96mm
 - 155mm - 600 x 430 x 155mm
- Lower Cupboard (internal)
 - 625 x 475 x 295mm

Standard Colours

- Paint - Red
- Lift Up Flap - White

Drop down cupboard door prevents drawers from being opened. Can be secured using security seals.

Item	Description	Overall Dimensions (w x d x h)	Weight
WT200	2 x 70mm & 1 x 155mm Deep Drawers, Lower Cupboard	825 x 575 x 999mm	74.0kg
WT210	3 x 96mm Deep Drawers, Lower Cupboard	825 x 575 x 999mm	75.1kg
WT250	4 x 70mm & 1 x 155mm Deep Drawers, Lower Cupboard	825 x 575 x 1165mm	86.0kg

Cardiac Board

Features

- Laminated cardiac board approx 500 x 400 x 17mm, complete with fixing brackets
- Positioned at the rear of the trolley for easy access
- Factory fitted

Item	Description	Weight
WT/CBOARD	Cardiac Board	1.5kg



Cylinder Holders

Features

- WT/CYL/D/E compatible with AD, CD, D, DD, PD, RD, ZD & E cylinders, max diameter 100mm
- WT/CYL/F compatible with F, LF, VF, HX & ZX cylinders, max diameter 145mm
- Maximum two cylinder holders per trolley
- Factory fitted

Item	Description	Weight
WT/CYL/D/E	D/E Size, Max Diameter 100mm	3.0kg
WT/CYL/F	F Size, Max Diameter 145mm	3.4kg



Drawer Tidy

Features

- Plastic drawer liner with removable dividers
- One tidy supplied as standard with each trolley

Item	Description	Weight
WT/DT	Drawer Tidy	1.6kg



Four Gang Socket

Features

- Switched & fused four gang socket
- Supplied with 3 metres of beige cable & fitted with a UK 3 pin plug
- Fitted to the rear of the trolley, complete with a cleat to secure the cable when not in use
- Factory fitted

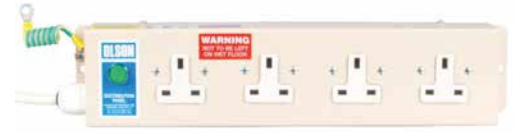

Item	Description	Weight
E/SOCKET/4	Four Gang Socket	1.4kg

Guard Rail

Features

- Stainless steel guard rail
- Increases the height of the trolley by 60mm
- Compatible with WT200, WT210 and WT250 models
- Factory fitted



Item	Description	Weight
G/RAIL-C	Guard Rail	1.5kg

Security Seals

Features

- Snap on plastic security
- Pack of 100



Item	Description
2PLCO026	Security Seals

Castors

Features

- Pressed steel castors
- Supplied as a set of 4 castors
- Factory fitted

Item	Description	Weight
C012	2 x Braking, 2 x Non-Braking (set of 4)	5.0kg



CTRESUSM1/10/3S2D/SS

Caretray Trolley - Resuscitation

Features

- Single column standard level resuscitation trolleys
- Designed for quick & easy complete disassembly when conducting thorough or deep cleaning programmes (including steam cleaning)
- Fully welded mild steel frame that is blast finished & powder coated in a durable epoxy paint (requires no on-site assembly)
- One piece moulded top with raised edges on three sides & integral rim at the front to contain any spillages (max load 30kg)
- One piece moulded side panels incorporate runners with positive stops, preventing trays from being accidentally withdrawn
- Carerails fitted to each side of the trolley to support a wide range of accessories (see options)
- Fitted with a back panel & tamper evident door providing security for the contents of the trays (security seal compatible)
- Trolley pre-configured with the following...
 - Cylinder Holder - Compatible with C/CD/D size cylinders
 - Single Glove / Mask Box Holder - Accommodates glove & mask boxes up to 140 mm x 95 mm
- 100/150mm deep translucent high impact plastic trays feature an integral handle with plastic clip on label cover, (max load per tray 5kg)
- Each trolley is supplied with six sheets of perforated coloured label strips - white, blue, green, yellow & red (not shown on trolley)
- Trays can be subdivided in both length & width using simple slot in dividers (each tray supplied with 2 x long & 2 x short dividers)
- Polyurethane ring buffers offer protection to both the trolley & fabric of the building; smooth surfaces assist cleaning
- 100mm polymer castors offering smooth surfaces to assist cleaning, 2 off braking

Dimensions (w x d x h)

- Overall Dimensions - 550 x 550 x 993mm
- Overall Dimensions (with overbridge) - 600 x 550 x 1620mm
- Plastic Top
 - Single Column - 455 x 455 (internal) at height 968mm
- Trays
 - Shallow - 355 x 405 x 100mm (internal)
 - Deep - 355 x 405 x 150mm (internal)

Standard Colours

- Paint - Red

Item	Description	Weight
CTRESUSM1/10/3S2D/SS	3 x 100mm, 2 x 150mm Trays	33.3kg
CTRESUSM1/10/4S1D/SS	4 x 100mm, 1 x 150mm Trays	32.9kg
CTRESUSM1/10/6S/SS	6 x 100mm Trays	34.0kg

Overbridge

Features

- Fixes onto the rear uprights of the trolley
- Provides a fixing location for tilt bins (order separately)
- Factory fitted

Standard Colours

- Paint - Grey White



CTRESUSM1/10/3S2D/SS shown with Overbridge & Tilt Bins



Item	Description	Weight
CT/OB/MS	Overbridge, Mild Steel	2.0kg

Tilt Bins

Features

- Available with 4, 5 or 6 tilting compartments
- Clear tilt bins provide visible storage & assists organisation
- Compartments tilt forward to a 45° angle allowing easy access of contents & can be removed to aid refilling/cleaning
- Label holder for easy identification of the contents
- Retaining bar secures compartments in place, preventing bins from tipping forward during transit
- Attaches to an overbridge (order separately)

Dimensions (w x d x h)

- Compartment Dimensions
- TBIN4/MS - 143 x 127 x 190mm
 - TBIN5/MS - 108 x 95 x 146mm
 - TBIN6/MS - 89 x 67 x 95mm

Standard Colours

- Plastic - Cream
- Paint - Grey White



45° Angle Tilt

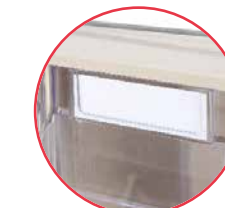

Label Holder

Top: TBIN6/MS
Middle: TBIN5/MS
Bottom: TBIN4/MS

Item	Description	Overall Dimensions (w x d x h)	Weight
TBIN4/MS	Four Compartment	600 x 171 x 207mm	2.3kg
TBIN5/MS	Five Compartment	600 x 135 x 164mm	1.6kg
TBIN6/MS	Six Compartment	600 x 93 x 113mm	0.9kg

Options (refer to page 62 for additional information)

- CT/AGH - Alcohol Gel Holder
- CT/AIR - Airway Tube Holder
- CT/BIN - Debris Bin & Bracket
- CT/DH/A4 - Document Holder, A4
- CT/CR2 - Catheter Rack, Two Section
- CT/CR5 - Catheter Rack, Five Section
- CT/FS - Flat Shelf - Removable
- CT/IV - Infusion Pole & Bracket
- CT/OB/MS - Overbridge
- TBIN4/MS - Tilt Bin, 4 Compartment (overbridge required)
- TBIN5/MS - Tilt Bin, 5 Compartment (overbridge required)
- TBIN6/MS - Tilt Bin, 6 Compartment (overbridge required)
- CT/WF - Work Flap
- GMBH/15 - Glove / Mask Box Holder - One Box, 15mm Hook
- SBH/15 - Sharps Box Holder - One Box, 15mm Hook
- CT/SBB/15 - Sharps Box Bracket - Universal (Daniels / Frontier / Sharpak)
- 2PLCO026 - Security Seals, Pack of 100



8LECCRP4
(defibrillator not included)

Resuscitation Carts - Polymer, Metro Lifeline™

Features

- Range of pre-configured emergency carts
- Incorporates Microban offering antimicrobial protection
- Lightweight polymer construction with smooth rounded corners to assist cleaning
- Single seal mechanism secures the top compartment, drawers and tilt out side bins (security seal compatible)
- Top storage compartment with clear removable cover provides instant access to first line equipment
- Strapless defibrillator platform on swing arm adjusts to accommodate various models
- Full extension lightweight polymer drawers, depths 76, 152, 229 & 305mm, (max load 7-20kg per drawer (dependent on drawer size)
- Ergonomic handle with fifth wheel steering provides maximum control when attending an emergency situation
- Two tone colour keyway
- 127mm castors, 2 x Braking

Dimensions (w x d x h)

- Drawers - 514 x 432 x 76 / 152 / 229 / 305mm (internal)

Standard Colours

- Body - Code Blue
- Drawers - Light Taupe/Code Blue

Options

- 8FL190 - Drawer Label Holders (x 10)



Drawer Label Holders

Item	Description	Overall Dimensions (w x d x h)	Weight
8LECCRP2	1 x 76mm, 3 x 152mm Drawers	965 x 575 x 984mm	84.0kg
8LECCRP3	2 x 76mm, 1 x 152mm, 1 x 229mm Drawers	965 x 575 x 984mm	88.0kg
8LECCRP4	2 x 76mm, 1 x 152mm, 1 x 305mm Drawers	965 x 575 x 1070mm	87.0kg



defibrillator not included

Top Cavity Tray		✓	
Locking Side Bin		3	3
Waste Basket (28 Litre)	✓		
Lockable Sharps Container	✓		
Adjustable Defibrillator Tray	✓	✓	✓
Suction Pump Shelf		✓	
Backboard (Front Fitting)		✓	✓
Backboard (Rear Fitting)	✓		
Oxygen Cylinder Holder	✓	✓	✓
Two Hook Infusion Pole	✓	✓	✓
Storage Bin	✓	✓	✓
Plastic Security Seals (x 100)	✓	✓	✓

	8LECCRP2	8LECCRP3	8LECCRP4
Top Cavity Tray		✓	
Locking Side Bin		3	3
Waste Basket (28 Litre)	✓		
Lockable Sharps Container	✓		
Adjustable Defibrillator Tray	✓	✓	✓
Suction Pump Shelf		✓	
Backboard (Front Fitting)		✓	✓
Backboard (Rear Fitting)	✓		
Oxygen Cylinder Holder	✓	✓	✓
Two Hook Infusion Pole	✓	✓	✓
Storage Bin	✓	✓	✓
Plastic Security Seals (x 100)	✓	✓	✓



8FL21P3369
(fitted with optional two hook infusion pole, oxygen cylinder holder & defibrillator platform. Defibrillator not included)

Resuscitation Carts - Polymer, Metro Flexline™

Features

- Lightweight polymer construction with smooth rounded corners to assist cleaning
- Incorporates Microban® offering antimicrobial protection
- Upper work surface provides a writing surface/space for preparation work
- Single seal mechanism secures the drawers (security seal compatible)
- Full extension lightweight polymer drawers, depths 76, 152, 229mm (max load 7-20kg per drawer (dependent on drawer size)
- Two tone colour keyway
- 127mm castors, 2 x Directional / 2 x Braking

Dimensions (w x d x h)

- Overall Dimensions - 819 x 568 x 914mm
- Drawers - 514 x 432 x 76 / 152 / 229mm (internal)

Standard Colours

- Body - Light Taupe
- Drawers - Light Taupe/Red

Options

- 8FL141 - 76mm Egg Crate Style Drawer Divider Kit (10 x Vertical, 5 x Horizontal)
- 8FL142 - 152mm Egg Crate Style Drawer Divider Kit (10 x Vertical, 5 x Horizontal)
- 8FL315 - Two Hook Infusion Pole
- 8FL234 - 100mm Diameter Oxygen Cylinder Holder
- 8FL190 - Drawer Label Holders (x 10)
- 8LEC320 - Plastic Security Seals (x 100)
- 8LEC304 - Defibrillator Platform

Item	Description	Weight
8FL21P3369	2 x 76mm, 1 x 152mm, 1 x 229mm Drawers, Red Drawer Pulls, Security Seal Lock	68.0kg

Airways / Difficult Intubation Trolley - Mild Steel

Features

- Designed specifically for airways / difficult intubation in conjunction with resuscitation officers
- Recessed liquid retaining top
- Available as non-locking or fitted with a side mounted tamper evident panel to secure the contents of the drawers (security seal compatible)
- 135mm deep drawers, fitted on full extension glides (max load 30kg per drawer)
- Two accessory rails fitted to L/H side
- Low level corner bumpers to protect the fabric of the building
- 80mm heavy duty castors, 2 off braking

Dimensions (w x d x h)

- Overall - 615 x 500 x 915mm
- Drawers - 480 x 375 x 135mm (internal)

Standard Colours

- Body - White
- Drawers - White

Options



CT/IV

CT/BIN

SBH/15

CT/AGH

GMBH/15

CT/DH/A4

CT/CYD

CT/AIR

CT/CR5 & CT/CR2



MW015 Tamper Evident Panel



MW010

Item	Description	Weight
MW010	5 x 125mm Drawers, Non Locking	55.0kg
MW015	5 x 125mm Drawers, Tamper Evident Panel	57.0kg



Sackholders & Waste Bins

Removable Body Bins	290
Free Standing Sackholders	295
Fixed Body Plastic Sackholders	296
Removable Body Plastic Sackholders	297



BR015/WHL

Removable Body Bins - 20 / 50 Litre

Features

- Premium range of removable body bins, fire retardant to HTM83
- Radiused corners to assist cleaning
- Captive drip tray to collect spills
- Positive bag retention through the use of a drop over clamp
- 'Hands free' design with recessed lid discourages opening by hand & encourage use of the pedal
- Stainless steel pedal & linkages
- Plastic feet to keep the unit clear of the floor
- Wheels fitted to rear of bin assist moving when cleaning
- Available with 'Colour Coding' to assist refuse identification, (HTM07)
- Choice of construction...
 - Mild steel tubular frame & sheet metal body, painted for extra durability
 - 'Rust Free' - All stainless steel construction, painted for extra durability
- Silent closing versions are fitted with a gas damper to minimise noise when the lid closes

Dimensions (w x d x h)

- 20 Litre - 267 x 346 x 552mm
- 50 Litre - 444 x 397 x 551mm

Standard Colours

- Paint - Grey Frame/White Body



'Rust Free' versions are constructed from painted stainless steel (frame, body & lid)

20 Litre

Item	Description	Weight
BR015/WHL	Hands Free	8.5kg
BR020/WHL	Hands Free & Silent Closing	8.5kg
BR025/WHL	Hands Free & Rust Free	8.5kg
BR030/WHL	Hands Free, Rust Free & Silent Closing	8.5kg



Positive bag retention through the use of a drop over clamp

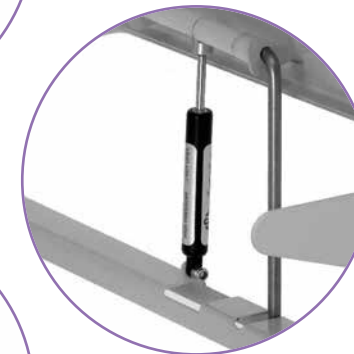

Gas strut used on silent closing bins

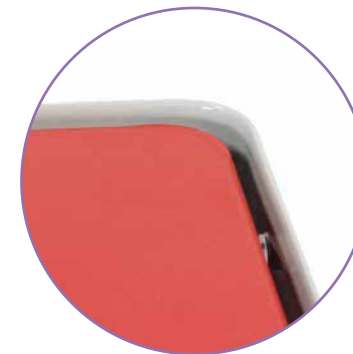

Raised flange & recessed lid used on hands free bins



BR045/WHL

50 Litre

Item	Description	Weight
BR045/WHL	Hands Free	11.5kg
BR050/WHL	Hands Free & Silent Closing	11.5kg
BR055/WHL	Hands Free & Rust Free	11.5kg
BR060/WHL	Hands Free, Rust Free & Silent Closing	11.5kg

Alternative lid colours are available. Change suffix 'WHL' on the product code with any of the following i.e. Removable Body Bin - 50ltr, Hands free with a green lid - BR045/GNL



WHL White



GYL Grey



YEL Yellow



BKL Black



ORL Orange



RDL Red



PPL Purple



BNL Brown



GNL Green



BLL Blue



YTL Yellow & Black



BR075/WHL

Removable Body Bins - 75 / 90 Litre

Features

- Premium range of removable body bins, fire retardant to HTM83
- Radiused corners to assist cleaning
- Captive drip tray to collect spills
- Positive bag retention through the use of a drop over clamp
- 'Hands free' design with recessed lid discourages opening by hand & encourage use of the pedal
- Stainless steel pedal & linkages
- Plastic feet to keep the unit clear of the floor
- Wheels fitted to rear of bin assist moving when cleaning
- Available with 'Colour Coding' to assist refuse identification, (HTM07)
- Choice of construction...
 - Mild steel tubular frame & sheet metal body, painted for extra durability
 - 'Rust Free' - All stainless steel construction, painted for extra durability
- Silent closing versions are fitted with a gas damper to minimise noise when the lid closes

Dimensions (w x d x h)

- 75 Litre - 444 x 397 x 781mm
- 90 Litre - 444 x 397 x 910mm

Standard Colours

- Paint - Grey Frame/White Body



'Rust Free' versions are constructed from painted stainless steel (frame, body & lid)

75 Litre

Item	Description	Weight
BR075/WHL	Hands Free	15.0kg
BR080/WHL	Hands Free & Silent Closing	15.0kg
BR085/WHL	Hands Free & Rust Free	15.0kg
BR090/WHL	Hands Free, Rust Free & Silent Closing	15.0kg



Positive bag retention through the use of a drop over clamp

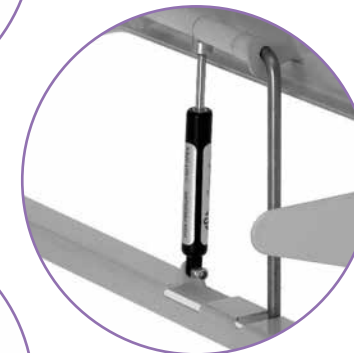

Gas strut used on silent closing bins

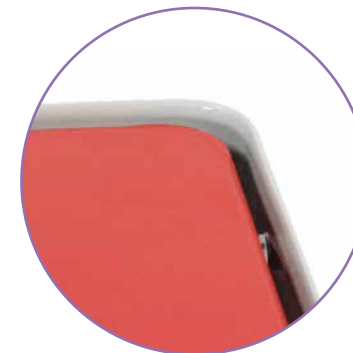

Raised flange & recessed lid used on hands free bins



BR105/WHL

90 Litre

Item	Description	Weight
BR105/WHL	Hands Free	17.0kg
BR110/WHL	Hands Free & Silent Closing	17.0kg
BR115/WHL	Hands Free & Rust Free	17.0kg
BR120/WHL	Hands Free, Rust Free & Silent Closing	17.0kg

Alternative lid colours are available. Change suffix 'WHL' on the product code with any of the following i.e. Removable Body Bin - 75ltr, Hands free with a yellow lid - BR075/YEL



WHL White



GYL Grey



YEL Yellow



BKL Black



ORL Orange



RDL Red



PPL Purple



BNL Brown



GNL Green



BLL Blue



YTL Yellow & Black



BR135/WHL



Positive bag retention through the use of a drop over clamp

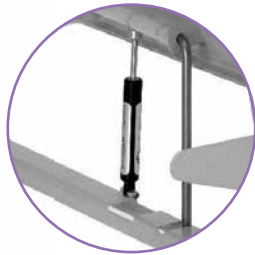

Gas strut used on silent closing bins

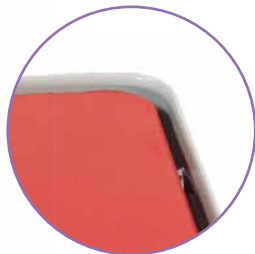

Raised flange & recessed lid used on hands free bins

Removable Body Bins - 75 Litre, Front Opening

Features

- Premium range of removable body bins, fire retardant to HTM83
- Radiused corners to assist cleaning
- Captive drip tray to collect spills
- Positive bag retention through the use of a drop over clamp
- 'Hands free' design with recessed lid discourages opening by hand & encourage use of the pedal
- Stainless steel pedal & linkages
- Plastic feet to keep the unit clear of the floor
- Wheels fitted to rear of bin assist moving when cleaning
- Available with 'Colour Coding' to assist refuse identification, (HTM07)
- Choice of construction...
 - Mild steel tubular frame & sheet metal body, painted for extra durability
 - 'Rust Free' - All stainless steel construction, painted for extra durability
- Silent closing versions are fitted with a gas damper to minimise noise when the lid closes

Dimensions (w x d x h)

- 75 Litre - 444 x 397 x 781mm

Standard Colours

- Paint - Grey Frame/White Body



'Rust Free' versions are constructed from painted stainless steel (frame, body & lid)

Alternative lid colours are available. Change suffix 'WHL' on the product code with any of the following i.e. Removable Body Bin - 75ltr, Hands Free & Silent Closing with a grey lid - BR140/**GYL**

WHL
WhiteGYL
GreyYEL
YellowBKL
BlackORL
OrangeRDL
RedPPL
PurpleBNL
BrownGNL
GreenBLL
BlueYTL
Yellow & Black

sales@bristolmaid.com

+44 (0)1258 484455

www.bristolmaid.com

Item	Description	Weight
BR135/WHL	Hands Free	15.0kg
BR140/WHL	Hands Free & Silent Closing	15.0kg
BR145/WHL	Hands Free & Rust Free	15.0kg
BR150/WHL	Hands Free, Rust Free & Silent Closing	15.0kg

Free Standing Sackholders - 50 / 75 Litre

Features

- Range of freestanding sackholders
- Mild steel tubular/sheet metal frame, painted for extra durability
- Captive drip tray to collect spills
- Positive bag retention through the use of an elasticated cord
- Plastic feet to keep the unit clear of the floor
- Stainless steel pedal and linkages
- Wheels fitted to rear of bin assist moving when cleaning
- Available with 'Colour Coding' to assist refuse identification, (HTM07)

Dimensions (w x d x h)

- 50 Litre - 442 x 397 x 551mm
- 75 Litre - 442 x 397 x 780mm

Standard Colours

- Paint - Grey Frame



BH015/WHL



BH030/WHL - Bags not supplied

Alternative lid colours are available. Change suffix 'WHL' on the product code with any of the following i.e. Free Standing Bag Holder - 50 Litre, Elastic Cord with brown lid - BH015/**BNL**

WHL
WhiteGYL
GreyYEL
YellowBKL
BlackORL
OrangeRDL
RedPPL
PurpleBNL
BrownGNL
GreenBLL
BlueYTL
Yellow & Black

sales@bristolmaid.com

+44 (0)1258 484455

www.bristolmaid.com

Item	Description	Weight
BH015/WHL	Elasticated Cord, 50 Litre	7.0kg
BH030/WHL	Elasticated Cord, 75 Litre	7.5kg

sales@bristolmaid.com

+44 (0)1258 484455

www.bristolmaid.com



5FSH20WH

Fixed Body Sackholders - Plastic, 20 Litre

Features

- Meets NHS England 'Managing Healthcare Fire Safety' (HTM-05-01)
- Fixed body
- Plastic construction with no metal parts
- Smooth surfaces to assist cleaning
- One piece plastic lid, available in a range of colours to assist refuse identification (HTM07)
- Soft closing lid
- Bag positively secured using a drop over sack retention ring

Dimensions (w x d x h)

- 350 x 220 x 660mm

Standard Colours

- Body - White
- Lid - White

Options

- Alternative Lid Colours - Black/Orange/Yellow/Yellow & Black
- Moulded In Graphics - Available on request

Alternative lid colours available. Change suffix 'WH' on the item no. with any of the following, i.e. Fixed Body Sackholder - Plastic, Silent Closing, 20 Litre with a black lid - 5FSH20BL



Item	Description	Weight
5FSH20WH	Fixed Body Sackholder - Plastic, Silent Closing, 20 Litre	3.0kg

Removable Body Sackholders - Plastic, 42 & 70 Litre

Features

- Meets NHS England 'Managing Healthcare Fire Safety' (HTM-05-03)
- One piece removable body
- Plastic construction with no metal parts
- Smooth surfaces to assist cleaning
- One piece plastic lid, available in a range of colours to assist refuse identification (HTM07)
- Soft operating lid on both opening & closing (moving parts enclosed)
- Recessed drip tray to collect unwanted spills
- Bag positively secured using a drop over sack retention ring
- Non-marking rubber feet prevents the bin from sliding
- Wheels to assist when cleaning

Dimensions (w x d x h)

- 42 Litre - 460 x 420 x 580mm
- 70 Litre - 460 x 450 x 790mm

Standard Colours

- Body - White
- Lid - White

Options

- Alternative Lid Colours - Black/Orange/Yellow/Yellow & Black
- Moulded In Graphics - Available on request

Alternative lid colours available. Change suffix 'WH' on the item no. with any of the following, i.e. Removable Body Sackholder - Plastic, Silent Closing, 42 Litre with a black lid - 5RSH42BL



Item	Description	Weight
5RSH42WH	Removable Body Sackholder - Plastic, Silent Closing, 42 Litre	8.0kg
5RSH70WH	Removable Body Sackholder - Plastic, Silent Closing, 70 Litre	9.0kg



5RSH42BL

5RSH70BL



Seating Solutions

Office, Task & Operators Chairs	300
24 Hour Task & Operator Chairs	302
Bariatric Chairs	304
Saddle Stools	306
Low Back Patient Chairs	308
Medium & High Back Patient Armchairs	309
Reclining Armchairs	310
Bariatric Reclining Armchairs	320
Reclining Porters Armchairs	322
Rise & Recline Porters Armchairs	324
Seat, Back Cushion & Headrest Options	326
Overnight Chair	328
Soft Seating	330
Visitor & Waiting Room Seating	332
Waiting Room Seating	334
Tech Chairs & Stools	340
PU Tech Chairs & Stools	342
Static Safe Tech Chairs & Stools	344
Static Safe & Sterile Tech Chairs & Stools	346
Medical Grade Clean Room Tech Chairs	348



Office, Task & Operators Chairs - Century

Features

- Available as...
 - Medium back
 - High back
 - Draughtsman
- Medium & high back available with fixed ring arms & non-braking castors
- Draughtsman has a medium back, foot ring & glides on a 27" base
- Vinyl or fabric upholstery
 - Vinyl - Fire retardant & antimicrobial
 - Fabric - Fire retardant
- Two lever mechanism
- Black polypropylene five star base
- Pneumatic seat & back rest height adjustment
- Fully upholstered seat & back with deep CMHR foam
- Maximum capacity 120kg

Replace suffix on the product code with any of the following to select your colour i.e. Medium Back Chair in Aztec - 5160/FAC

Vinyl - Ambla New Richmond in Colour



Fabric - Camira Advantage

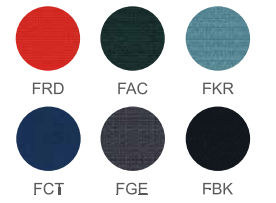

Item	Description	Overall Dimensions (w x d x h)	Seat Height Adjustment	Weight
5160	Century, Medium Back	670 x 670 x 800-1040mm	440-570mm	10.0kg
5161	Century, Medium Back, Ring Arms	670 x 670 x 800-1040mm	440-570mm	12.0kg
5162	Century, High Back	670 x 670 x 940-1070mm	440-570mm	11.0kg
5163	Century, High Back, Ring Arms	670 x 670 x 980-1110mm	440-570mm	13.0kg
5160D	Century, Draughtsman	460 x 605 x 1010-1200mm	536-686mm	12.0kg



5262/FYR02



5260/FYR15



24 Hour Task & Operator Chairs - Eon

Features

- BS 5459: Part 2: 2000. Specification for performance requirements & tests for office furniture. Office pedestal seating for use by persons weighing up to 150kg & for use up to 24 hours a day
- S1 level tested (severe) for heavy duty use
- Certified for use up to 150kg
- Available as...
 - Medium back
 - High back
- 24/7 Flax fire retardant heavy duty fabric upholstery
- Black polypropylene five-star base
- Easy lift back, ratchet height adjustable
- Independent seat & back mechanism with tension control
- Fully upholstered seat & back with deep CMHR foam
- Optional
 - Height adjustable, fold back or ring arms
 - 12" or 14" draughtsman's kit
- Maximum capacity 150kg

Replace suffix on the product code with any of the following to select your colour i.e. Eon, Medium Back in Zone - 5260/**FYR09**

Fabric - Camira 24/7 Flax

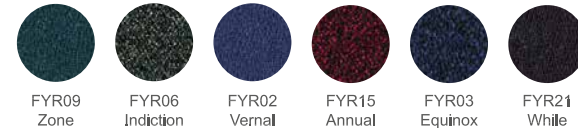

Item	Description	Overall Dimensions (w x d x h)	Seat Height Adjustment	Weight
5260	Eon, Medium Back	710 x 710 x 835-925mm	470-600mm	13.0kg
5262	Eon, High Back	710 x 710 x 925-1030mm	470-600mm	14.0kg

24 Hour Task & Operator Chairs - Zenith

Features

- BS 5459: Part 2: 2000. Specification for performance requirements & tests for office furniture. Office pedestal seating for use by persons weighing up to 150kg & for use up to 24 hours a day
- S1 level tested (severe) for heavy duty use
- Certified for use up to 150kg
- 24/7 Flax fire retardant heavy duty fabric upholstery
- Black polypropylene five-star base
- Easy lift back, ratchet height adjustable
- Independent seat & back mechanism with tension control & seat slider
- Fully upholstered seat & back with deep CMHR foam
- Chrome swivel height adjustable arms & seat slider
- Maximum capacity 150kg

Options

- 5/Z/HR - Headrest
- 5/Z/PLS - Pump-Up Lumbar Support

Replace suffix on the product code with any of the following to select your colour i.e. Zenith, High Back in Vernal - 59003/**FYR02**

Fabric - Camira 24/7 Flax

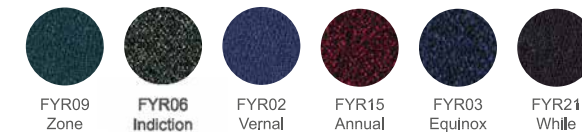

Item	Description	Overall Dimensions (w x d x h)	Seat Height Adjustment	Weight
59003	Zenith, High Back	710 x 710 x 1160-1240mm	450-530mm	21.0kg

59003/FYR02/5/Z/HR/5/Z/PLS
shown with optional headrest
& pump-up lumbar support



5660XL/FCT

Bariatric High Back Chairs

Features

- Deep CMHR foam
- Vinyl or fabric upholstery
 - Vinyl - Fire retardant & antimicrobial
 - Fabric - Fire retardant
- Black heavy duty steel five star base
- Black heavy duty gas lift
- Black height adjustable soft touch armrests
- Easy lift ratchet height adjustable back
- Independent seat & back mechanism with side tension control
- Maximum capacity 315kg

Replace suffix on the product code with any of the following to select your colour i.e. Bariatric High Back in Lime - 5660XL/VLI

Vinyl - Ambla New Richmond in Colour

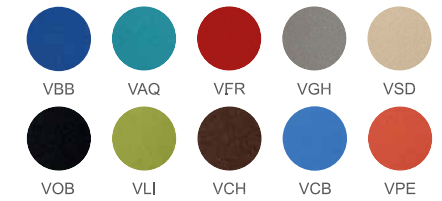

Fabric - Camira Advantage

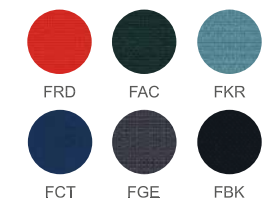

Item	Description	Overall Dimensions (w x d x h)	Seat Height Adjustment	Weight
5660XL	High Back, Swivel	750 x 750 x 1080-1190mm	425-535mm	29.0kg

Bariatric Chairs

Features

- Deep CMHR foam
- Vinyl or fabric upholstery
 - Vinyl - Fire retardant & antimicrobial
 - Fabric - Fire retardant
- Steel or beech four leg frames
 - Steel - Powder coated
 - Beech - Varnished
- Maximum capacity 315kg

Replace suffix on the product code with any of the following to select your colour i.e. Bariatric, Steel Frame in Lime - 5670/VLI

Vinyl - Ambla New Richmond in Colour



Fabric - Camira Advantage

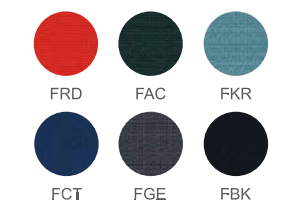

Item	Description	Overall Dimensions (w x d x h)	Seat Height	Weight
5670	Bariatric, Steel Frame	920 x 600 x 885mm	500mm	15.8kg
5671	Bariatric, Beech Frame	844 x 580 x 890mm	490mm	16.0kg



5671/VCB

5670/VBB



Saddle Stools

Features

- Vinyl or fabric upholstery
 - Vinyl - Fire retardant & antimicrobial
 - Fabric - Fire retardant
- Black polypropylene five star base
- Black gas lift with pneumatic seat height adjustment
- Free wheeling castors
- Maximum capacity 120kg

Replace suffix on the product code with any of the following to select your colour i.e. Saddle Stool in Lime - 5202/VLI

Vinyl - Ambla New Richmond in Colour

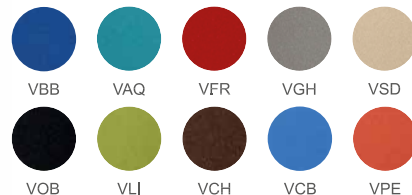

Fabric - Camira Advantage

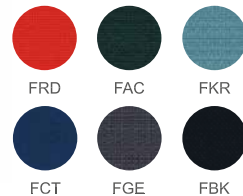

Item	Description	Overall Dimensions (w x d x h)	Seat Height Adjustment	Weight
5202	Saddle Stool	670 x 670 x 555-730mm	555-730mm	8.0kg

PU Saddle & Perch Stools

Features

- Soft touch black polyurethane seat
- Black polypropylene five star base
- Black gas lift with pneumatic seat height adjustment
- Free wheeling castors
- Maximum capacity 120kg



Item	Description	Overall Dimensions (w x d x h)	Seat Height Adjustment	Weight
5201	PU Saddle Stool	670 x 670 x 590-780mm	590-780mm	8.0kg
5205	PU Perch Stool	670 x 670 x 650-730mm	510-690mm	8.0kg



5ND/LC/ALDE/VVDEL



Low Back Patient Chairs - Alderbury

Features

- BS EN 16139: 2013 Level 2. Furniture. Strength, durability & safety. Requirements for non-domestic seating
- Ergonomic design to ensure correct sit & posture
- Handgrips assist positioning from standing & seated positions
- Solid beech frame (PEFC accredited)
- Mortice & tenon joint construction, glued & pinned
- Frame finished with anti-bacterial varnish
- Plastic glides fitted to chair legs
- Contoured seat & back, seat section fixed
- Hygiene gap prevents the trapping of dirt & bacteria between the seat & back, provides access for cleaning
- Fire retardant foam (BS 5852: Part 2: 1982)
- Upholstered with fire retardant & antimicrobial vinyl
- Maximum capacity 160kg

Standard Colours

- Vinyl - Delft

Dimensions (w x d x h)

- Overall - 580 x 540 x 890mm
- Seat - 470 x 430 at Height 470mm
- Width Between Arms - 470mm
- Arm Height - 655mm

Alternative colours available at additional cost. Change suffix 'VVDEL' on the product code with any of the following i.e. Alderbury, Low Back Chair in Baltic - 5ND/LC/ALDE/VVBAL

Vinyl - Spradling Valencia C5



Item	Description	Weight
5ND/LC/ALDE/VVDEL	Alderbury, Low Back Chair, Fixed Seat	8.2kg

Medium & High Back Patient Armchairs - Alderbury

Features

- BS EN 16139: 2013 Level 2. Furniture. Strength, durability & safety. Requirements for non-domestic seating
- Ergonomic design to ensure correct sit & posture
- Handgrips assist positioning from standing & seated positions
- Solid beech frame (PEFC accredited)
- Mortice & tenon joint construction, glued & pinned
- Frame finished with anti-bacterial varnish
- Plastic glides fitted to chair legs
- Contoured seat & back
 - Fixed - Seat is fixed to the frame
 - Removable - Seat can be removed to assist cleaning (smooth vinyl upholstered underside) & is reversible to allow the seat section to be repositioned to provide additional clearance at the front of the chair
- Hygiene gap prevents the trapping of dirt & bacteria between the seat & back, provides access for cleaning
- Fire retardant foam (BS 5852: Part 2: 1982)
- Upholstered with fire retardant & antimicrobial vinyl
- Maximum capacity 160kg

Dimensions (w x d x h)

- Medium Back - 660 x 650 x 1000mm
- High Back - 660 x 650 x 1195mm
- Seat - 450 x 435/475* at Height 500mm
- Width Between Arms - 530mm
- Arm Height - 655mm

*Seat depth can be altered by repositioning the removable seat pad



Optional house keeping wheels assist movement of the chair during cleaning

Standard Colours

- Vinyl - Delft

Options

- HW - Housekeeping Wheels

Item	Description	Weight
Medium Back		
5ND/MAF/ALDE/VVDEL	Alderbury, Medium Back Armchair, Fixed Seat	13.6kg
5ND/MAR/ALDE/VVDEL	Alderbury, Medium Back Armchair, Removable Seat	13.6kg
High Back		
5ND/HAF/ALDE/VVDEL	Alderbury, High Back Armchair, Fixed Seat	14.4kg
5ND/HAR/ALDE/VVDEL	Alderbury, High Back Armchair, Removable Seat	14.4kg



5ND/HAR/ALDE/VVDEL



5ND/MAR/ALDE/VVDEL

Alternative colours available at additional cost. Change suffix 'VVDEL' on the product code with any of the following i.e. Alderbury, High Back Armchair, Removable & Reversible Seat in Olive - 5ND/HAR/ALDE/VVOLI

Vinyl - Spradling Valencia C5





5RE/RAM/SHAP/VVDEL



CE

Reclining Armchair - Shapwick

Features

- Available as either manual or electric operation
 - Manual - Tilt in space recliner
 - Electric - Single tilt in space reclining only or single tilt in space reclining with rise function
- Manual chairs use a smooth easy to use push operation
- Electric chairs are fitted with a mains powered actuator (230V ~, 50/60Hz) fitted with a UK 3 pin plug & supplied with a handset
- Optional AccuPack system allows the chair to be used without being connected to an electrical supply (average of 100 cycles based on a 24hr charge)
- Upholstered with either
 - Flame retardant antimicrobial vinyl throughout
 - A combination of flame retardant antimicrobial vinyl & vapour permeable (VP) multiway stretch fabric. VP fabric applied to seat & back sections
- Easiform reflex foam provides comfort when sitting (fixed seat)
- Foam leg rest
- 4 x 50mm swivel braking castors
- Maximum capacity 127kg

Dimensions (w x d x h)

- Overall Dimensions - 737 x 902 x 1130mm
- Seat - 510 x 510mm at Height 460mm

Standard Colours

- Vinyl - Delft
- VP Fabric - Navy Blue

Options

- Seat Pressure Management - Coolform, Viscoform, Liquiform, Celliform
- Headrests - Head Pillow, Head Roll, Small Profile, Large Profile, Midline
- Full Length Arm Caps - Positioned over the arm rests
- AccuPack System - Allows mains free chair movements

Item	Description	Weight
5RE/RAM/SHAP/VVDEL	Reclining Armchair, Manual	41.0kg
5RE/RAE/SHAP/VVDEL	Reclining Armchair, Electric	55.0kg
5RE/RAE/SHAP/VVDEL	Rise & Reclining Armchair, Electric	57.0kg



5RE/RAM/SHAP/VVROT/VPBL

WHITE
GLOVE
DELIVERY
*UK mainland only

- Delivery to Chosen Location
- Unwrapping & Removal of Packaging
- Product Positioning & Set-Up
- Full Demonstration of Use to Staff

Alternative colours available at additional cost.

Change vinyl suffix 'VVDEL' then change VP fabric suffix 'VPNB' i.e. Shapwick, Reclining Armchair, Electric in Olive Vinyl & Green Vapour Permeable (VP) Multi-Way Stretch Fabric - 5RE/RAE/SHAP/VVOLI/VPGR

Vinyl - Spradling Valencia C5



Fabric - VP Multi-Way Stretch

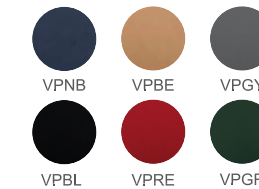

Item	Description	Weight
5RE/RAM/SHAP/VVDEL/VPNB	Reclining Armchair, Manual	41.0kg
5RE/RAE/SHAP/VVDEL/VPNB	Reclining Armchair, Electric	55.0kg
5RE/RAE/SHAP/VVDEL/VPNB	Rise & Reclining Armchair, Electric	57.0kg



5RE/RAE/SHAP/VVDEL



5RE/RAE/ALWE/VVDEL
(fitted with optional pocket)



Reclining Armchair - Alweston, Wide Arm

Features

- Ideal for use in oncology, dialysis or haematology for intravenous cannulation, where a patient may be seated for a prolonged period of time, or alternatively in recovery following minor treatment
- Wide supportive cushioned arm (150mm)
- Available as either manual or electric operation
 - Manual - Tilt in space recliner
 - Electric - Single tilt in space reclining only, or single tilt in space reclining with rise function
- Manual chairs use a smooth easy to use push operation
- Electric chairs are fitted with a mains powered actuator (230V ~, 50/60Hz) fitted with a UK 3 pin plug & supplied with a handset
- Optional AccuPack system allows the chair to be used without being connected to an electrical supply (average of 100 cycles based on a 24hr charge)
- Upholstered with either
 - Flame retardant antimicrobial vinyl throughout
 - A combination of flame retardant antimicrobial vinyl & vapour permeable (VP) multiway stretch fabric. VP fabric applied to seat & back sections
- Easiform reflex foam provides comfort when sitting (fixed seat)
- Foam leg rest
- 4 x 50mm swivel braking castors
- Maximum capacity 127kg

Dimensions (w x d x h)

- Overall Dimensions - 737 x 902 x 1130mm
- Seat - 510 x 510mm at Height 460mm

Standard Colours

- Vinyl - Delft
- VP Fabric - Navy Blue

Options

- Seat Pressure Management - Coolform, Viscoform, Liquiform, Celliform
- Headrests - Head Pillow, Head Roll, Small Profile, Large Profile, Midline
- Table with Wireless Charging - See page 327
- Full Length Arm Caps - Positioned over the arm rests
- AccuPack System - Allows mains free chair movements
- USB Charging Socket - Located on outside of arm
- Pocket - Positioned on the right-hand side of the chair

Item	Description	Weight
5RE/RAM/ALWE/VVDEL	Reclining Armchair, Wide Arm, Manual	41.0kg
5RE/RAE/ALWE/VVDEL	Reclining Armchair, Wide Arm, Electric	55.0kg
5RE/RRAE/ALWE/VVDEL	Rise & Reclining Armchair, Wide Arm, Electric	57.0kg



5RE/RAE/ALWE/VVLEI/VPBE
(fitted with optional pocket)

Alternative colours available at additional cost. Change vinyl suffix 'VVDEL' then change VP fabric suffix 'VPNB' i.e. Ashington, Reclining Armchair, Waterfall Back, Wide Arm, Electric in Olive Vinyl & Green VP Multi-Way Stretch Fabric - 5RE/RAE/ASHI/VVOLI/VPGR

Vinyl - Spradling Valencia C5



Fabric - VP Multi-Way Stretch



Item	Description	Weight
5RE/RAM/ALWE/VVDEL/VPNB	Reclining Armchair, Wide Arm, Manual	41.0kg
5RE/RAE/ALWE/VVDEL/VPNB	Reclining Armchair, Wide Arm, Electric	55.0kg
5RE/RRAE/ALWE/VVDEL/VPNB	Rise & Reclining Armchair, Wide Arm, Electric	57.0kg



5RE/RAE/ALWE/VVBAL/VPGY



- Delivery to Chosen Location
- Unwrapping & Removal of Packaging
- Product Positioning & Set-Up
- Full Demonstration of Use to Staff



5RE/RRAE/TWYF/VVDEL



Reclining Armchair - Twyford, Waterfall Back

Features

- Available as either manual or electric operation
 - Manual - Tilt in space recliner
 - Electric - Single tilt in space reclining only or single tilt in space reclining with rise function
- Manual chairs use a smooth easy to use push operation
- Electric chairs are fitted with a mains powered actuator (230V ~, 50/60Hz) fitted with a UK 3 pin plug & supplied with a handset
- Optional AccuPack system allows the chair to be used without being connected to an electrical supply (average of 100 cycles based on a 24hr charge)
- Upholstered with either
 - Flame retardant antimicrobial vinyl throughout
 - A combination of flame retardant antimicrobial vinyl & vapour permeable (VP) multiway stretch fabric. VP fabric applied to seat & back sections
- Easiform reflex foam provides comfort when sitting (fixed seat)
- Foam leg rest
- Fixed deep padded waterfall back
- 2 x 50mm swivel braking castors
- Maximum capacity 127kg

Dimensions (w x d x h)

- Overall Dimensions - 765 x 865 x 1145mm
- Seat - 520 x 510mm at Height 482mm

Standard Colours

- Vinyl - Delft
- VP Fabric - Navy Blue

Options

- Seat Pressure Management - Coolform, Viscoform, Liquiform
- Headrests - Head Pillow, Head Roll, Small Profile, Large Profile, Midline
- Full Length Arm Caps - Positioned over the arm rests
- AccuPack System - Allows mains free chair movements



- Delivery to Chosen Location
- Unwrapping & Removal of Packaging
- Product Positioning & Set-Up
- Full Demonstration of Use to Staff

Item	Description	Weight
5RE/RAM/TWYF/VVDEL	Reclining Armchair, Waterfall Back, Manual	43.0kg
5RE/RAE/TWYF/VVDEL	Reclining Armchair, Waterfall Back, Electric	57.0kg
5RE/RRAE/TWYF/VVDEL	Rise & Recline Armchair, Waterfall Back, Electric	59.0kg



5RE/RAM/TWYF/VVDEL/VPGR

Alternative colours available at additional cost.
Change vinyl suffix 'VVDEL' then change VP fabric suffix 'VPNB' i.e. Twyford, Reclining Armchair, Electric in Olive Vinyl & Green Vapour Permeable (VP) Multi-Way Stretch Fabric - 5RE/RAE/TWYF/VVOLI/VPGR

Vinyl - Spradling Valencia C5



Fabric - VP Multi-Way Stretch

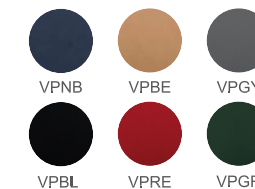

Item	Description	Weight
5RE/RAM/TWYF/VVDEL/VPNB	Reclining Armchair, Waterfall Back, Manual	43.0kg
5RE/RAE/TWYF/VVDEL/VPNB	Reclining Armchair, Waterfall Back, Electric	57.0kg
5RE/RRAE/TWYF/VVDEL/VPNB	Rise & Recline Armchair, Waterfall Back, Electric	59.0kg



5RE/RRAE/TWYF/VVLIC/VPRE

Reclining Armchair - Ashington, Waterfall Back, Wide Arm



Features

- Ideal for use in oncology, dialysis or haematology for intravenous cannulation, where a patient may be seated for a prolonged period of time, or alternatively in recovery following minor treatment
- Wide supportive cushioned arm (150mm)
- Available as either manual or electric operation
 - Manual - Tilt in space recliner
 - Electric - Single tilt in space reclining only, or single tilt in space reclining with rise function
- Manual chairs use a smooth easy to use push operation
- Electric chairs are fitted with a mains powered actuator (230V ~, 50/60Hz) fitted with a UK 3 pin plug & supplied with a handset
- Optional AccuPack system allows the chair to be used without being connected to an electrical supply (average of 100 cycles based on a 24hr charge)
- Upholstered with either
 - Flame retardant antimicrobial vinyl throughout
 - A combination of flame retardant antimicrobial vinyl & vapour permeable (VP) multiway stretch fabric. VP fabric applied to seat & back sections
- Easiform reflex foam provides comfort when sitting (fixed seat)
- Foam leg rest
- Fixed deep padded waterfall back
- 2 x 50mm swivel braking castors
- Maximum capacity 127kg

Dimensions (w x d x h)

- Overall Dimensions - 765 x 865 x 1145mm
- Seat - 520 x 510mm at Height 482mm

Standard Colours

- Vinyl - Delft
- VP Fabric - Navy Blue

Options

- Seat Pressure Management - Coolform, Viscoform, Liquiform
- Headrests - Head Pillow, Head Roll, Small Profile, Large Profile, Midline
- Table with Wireless Charging - See page 327
- Full Length Arm Caps - Positioned over the arm rests
- AccuPack System - Allows mains free chair movements
- USB Charging Socket - Located on outside of arm
- Pocket - Positioned on the right-hand side of the chair

Item	Description	Weight
5RE/RAM/ASHI/VVDEL	Reclining Armchair, Waterfall Back, Wide Arm, Manual	43.0kg
5RE/RAE/ASHI/VVDEL	Reclining Armchair, Waterfall Back, Wide Arm, Electric	57.0kg
5RE/RRAE/ASHI/VVDEL	Rise & Recline Armchair, Waterfall Back, Wide Arm, Electric	59.0kg



5RE/RAE/ASHI/VVSCH/VPGY
(fitted with optional pocket)



5RE/RAE/ASHI/VVROT/VPNB

Alternative colours available at additional cost.
Change vinyl suffix 'VVDEL' then change VP fabric suffix 'VPNB' i.e. Alwston, Reclining Armchair, Wide Arm, Electric in Olive Vinyl & Green Vapour Permeable VP Multi-Way Stretch Fabric - 5RE/RAE/ALWE/VVOLI/VPGR

Vinyl - Spradling Valencia C5



Fabric - VP Multi-Way Stretch

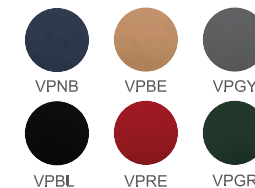

Item	Description	Weight
5RE/RAM/ASHI/VVDEL/VPNB	Reclining Armchair, Waterfall Back, Wide Arm, Manual	43.0kg
5RE/RAE/ASHI/VVDEL/VPNB	Reclining Armchair, Waterfall Back, Wide Arm, Electric	57.0kg
5RE/RRAE/ASHI/VVDEL/VPNB	Rise & Recline Armchair, Waterfall Back, Wide Arm, Electric	59.0kg



- Delivery to Chosen Location
- Unwrapping & Removal of Packaging
- Product Positioning & Set-Up
- Full Demonstration of Use to Staff



5RE/RRAE/BECK/VMULT

Alternative colours available at additional cost. Change suffix 'VMULT' on the product code with any of the following i.e. Beckington, Reclining Armchair, Waterfall Back, Electric in Garden - 5RE/RAE/BECK/VMGAR

Memphis Faux Leather

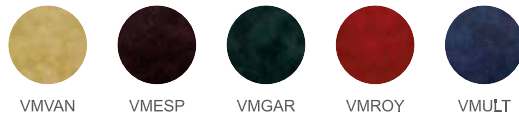

VMVAN VMESP VMGAR VMROY VMULT

Reclining Armchair - Beckington, Waterfall Back

Features

- Electric reclining only, or dual tilt in space reclining with rise function
- Mains powered actuator (230V ~, 50/60Hz) fitted with a UK 3 pin plug & supplied with a handset
- Upholstered with flame retardant vinyl
- Easiform reflex foam provides comfort when sitting
- Foam leg rest
- Fixed waterfall back
- Side pocket & loop for handset
- 2 x 50mm swivel braking castors
- Maximum capacity 127kg

Dimensions (w x d x h)

- Overall Dimensions - 840 x 930 x 1160mm
- Seat - 510 x 510mm at Height 483mm
- Back Height - 710mm
- Arm Height - 180mm

Standard Colours

- Vinyl - Ultra



- Delivery to Chosen Location
- Unwrapping & Removal of Packaging
- Product Positioning & Set-Up
- Full Demonstration of Use to Staff

Item	Description	Weight
5RE/RAE/BECK/VMULT	Reclining Armchair, Waterfall Back, Electric	58.0kg
5RE/RRAE/BECK/VMULT	Rise & Recline Armchair, Waterfall Back, Electric	62.0kg



Handset



5RE/RAE/BECK/VMGAR

5RE/RRAE/BECK/VMROY

Reclining Armchair - Hadleigh, Waterfall Back, Bariatric



Features

- Specifically designed for comfort & pressure management control
- Dual standard rise & recliner, provides a full range of posture positive recline positions as well as support to a standing position
- Mains powered actuator (230V ~, 50/60Hz) fitted with a UK 3 pin plug & supplied with a handset
- Upholstered with a combination of flame retardant antimicrobial vinyl & vapour permeable (VP) multiway stretch fabric. VP fabric applied to seat & back sections
- Easiform reflex foam provides comfort when sitting
- Seat & leg sections generously padded with memory foam & fitted with a removable cover
- Separate waterfall back cushions can be individually repositioned & adjusted for comfort & support
- Back blockers provided for additional lumbar support
- Flat wide arms for deep comfort & support
- Loop for handset & deep side pocket
- Heavy duty glides
- Maximum capacity 254kg

Dimensions (w x d x h)

- Chair - 1000 / 1100 x 940 x 1145mm
- Seat - 610 / 710mm x 510 x 460mm

Standard Colours

- Vinyl - Delft
- VP Fabric - Navy Blue

Options

- Seat Pressure Management - Coolform, Viscoform
- Headrests - Head Pillow, Head Roll, Small Profile, Large Profile, Midline
- USB Charging Socket - Located on outside of arm
- Full Length Arm Caps - Positioned over the arm rests



5RE/RRAE/HADL610/VVOLI/VPGR



- Delivery to Chosen Location
- Unwrapping & Removal of Packaging
- Product Positioning & Set-Up
- Full Demonstration of Use to Staff

Alternative colours available at additional cost. Change vinyl suffix 'VVDEL' then change VP fabric suffix 'VPNB' i.e. Hadleigh, Rise & Reclining Armchair, Waterfall Back, Bariatric, Electric, 710mm in Olive Vinyl & Green VP Multi-Way Stretch Fabric - 5RE/RRAE/HADL710/VVOLI/VPGR

Vinyl - Spradling Valencia C5



Fabric - VP Multi-Way Stretch

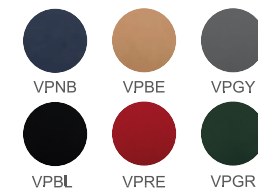

5RE/RRAE/HADL610/VVROT/VPRE

Item	Description	Weight
5RE/RRAE/HADL610/VVDEL/VPNB	Rise & Reclining Armchair, Waterfall Back, Bariatric, Electric, 610mm	88.0kg
5RE/RRAE/HADL710/VVDEL/VPNB	Rise & Reclining Armchair, Waterfall Back, Bariatric, Electric, 710mm	88.0kg

Reclining Porters Armchair - Bathampton, Waterfall Back



5RE/RPAH/BATH/VVDEL



Features

- Single tilt in space recliner, provides a full range of posture positive recline positions
- Mains powered actuator (230V ~, 50/60Hz) fitted with a UK 3 pin plug & supplied with a handset (positioned at rear of chair/optional side of chair)
- Optional AccuPack system allows the chair to be used without being connected to an electrical supply (average of 100 cycles based on a 24hr charge)
- Upholstered with either
 - Flame retardant antimicrobial vinyl throughout
 - A combination of flame retardant antimicrobial vinyl & vapour permeable (VP) multi-way stretch fabric. VP fabric applied to seat & back sections
- Upholstered seat & back sections are fitted with removable covers, allows seat section to be easily upgraded to aid pressure care
- Removable internal Easiform reflex seat cushion
- Seat & leg sections generously padded with memory foam & fitted with a removable cover
- Separate waterfall back cushions can be individually repositioned & adjusted for comfort & support
- Push handle at rear of the chair to assist when positioning/portering
- Slide out footplate to support feet
- 4 x 75mm swivel braking castors
- Maximum capacity 127kg

Dimensions (w x d x h)

- Overall Dimensions - 685 x 990 x 1220mm
- Seat - 520 x 510mm at Height 470mm

Standard Colours

- Vinyl - Delft
- VP Fabric - Navy Blue

Options

- Seat Pressure Management - Coolform, Viscoform, Liquiform, Celliform, Airform, Dynaform
- Back Cushions - Comfort Lateral, Support Lateral, Large Profile with Waterfall, Large Profile Headrest with Comfort Lateral, Large Profile Headrest with Support Lateral
- Headrests - Head Pillow, Head Roll, Small Profile, Large Profile, Midline
- Full Length Arm Caps - Positioned over the arm rests
- AccuPack System - Allows mains free chair movements

Item	Description	Weight
5RE/RPAH/BATH/VVDEL	Reclining Porters Armchair, Waterfall Back, Electric	75.0kg



5RE/RPAH/BATH/VVOLI/VPGR



- Delivery to Chosen Location
- Unwrapping & Removal of Packaging
- Product Positioning & Set-Up
- Full Demonstration of Use to Staff

Alternative colours available at additional cost.
Change vinyl suffix 'VVDEL' then change VP fabric suffix 'VPNB' i.e. Bathampton, Waterfall Back, Handset Operated in Olive Vinyl & Green VP Multi-Way Stretch Fabric - 5RE/RPAH/BATH/VVOLI/VPGR

Vinyl - Spradling Valencia C5



Fabric - VP Multi-Way Stretch

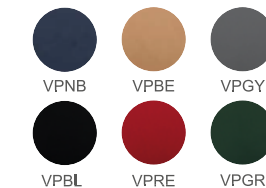

Item	Description	Weight
5RE/RPAH/BATH/VVDEL/VPNB	Reclining Porters Armchair, Waterfall Back, Electric	75.0kg



5RE/RPAH/BATH/VVDEL/VPNB

Rise & Recline Porters Armchair - Dorchester, Waterfall Back



5RE/RRPAH/DORC/VVDEL
(with optional sliding footplate)

Features

- Dual tilt in space rise & recliner, provides a full range of posture positive recline positions as well as support to a standing position
- Mains powered actuator (230V ~, 50/60Hz) fitted with a UK 3 pin plug & supplied with a handset (positioned at side of chair)
- Optional AccuPack system allows the chair to be used without being connected to an electrical supply (average of 100 cycles based on a 24hr charge)
- Upholstered with either
 - Flame retardant antimicrobial vinyl throughout
 - A combination of flame retardant antimicrobial vinyl & vapour permeable (VP) multi-way stretch fabric. VP fabric applied to seat & back sections
- Upholstered seat & back sections are fitted with removable covers, allows seat section to be easily upgraded to aid pressure care
- Removable internal Easiform reflex seat cushion
- Seat & leg sections generously padded with memory foam & fitted with a removable cover
- Separate waterfall back cushions can be individually repositioned & adjusted for comfort & support
- Push handle at rear of the chair to assist when positioning/portering
- Optional sliding footplate to support feet
- 4 x 100mm swivel braking castors
- Maximum capacity 127kg

Dimensions (w x d x h)

- Overall Dimensions - 775 x 1055 x 1245mm
- Seat - 510 x 510mm at Height 480mm

Standard Colours

- Vinyl - Delft
- VP Fabric - Navy Blue

Options

- Sliding Footplate
- Seat Pressure Management - Coolform, Viscoform, Liquiform, Celliform, Airform, Dynaform
- Back Cushions - Comfort Lateral, Support Lateral, Large Profile with Waterfall, Large Profile Headrest with Comfort Lateral, Large Profile Headrest with Support Lateral
- Headrests - Head Pillow, Head Roll, Small Profile, Large Profile, Midline
- Full Length Arm Caps - Positioned over the arm rests
- AccuPack System - Allows mains free chair movements

Item	Description	Weight
5RE/RRPAH/DORC/VVDEL	Rise & Recline Porters Armchair, Waterfall Back, Electric	76.5kg



- Delivery to Chosen Location
- Unwrapping & Removal of Packaging
- Product Positioning & Set-Up
- Full Demonstration of Use to Staff



5RE/RRPAH/DORC/VVBAL/VPNB
(with optional footplate)

Alternative colours available at additional cost.
Change vinyl suffix 'VVDEL' then change VP fabric suffix 'VPNB' i.e. Dorchester, Waterfall Back, Handset Operated in Leinen Vinyl & Grey VP Multi-Way Stretch Fabric - 5RE/RRPAH/DORC/VVOLI/VPGY

Vinyl - Spradling Valencia C5



Fabric - VP Multi-Way Stretch

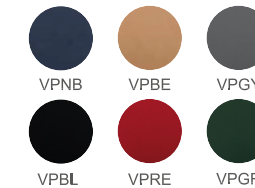

Item	Description	Weight
5RE/RRPAH/DORC/VVDEL/VPNB	Rise & Recline Porters Armchair, Waterfall Back, Electric	76.5kg



5RE/RRPAH/DORC/VVLEI/VPNB
(with optional sliding footplate)

Seat Options For Pressure Management

Cushions are covered in multi-way stretch, vapour permeable fabric which is wipeable, removable, washable at 95°C, incontinence proof & breathable.

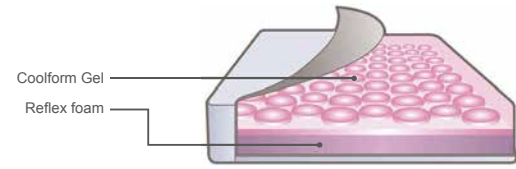

Coolform Pressure Risk **MEDIUM** → **HIGH**

For those sitting for long periods with specific comfort issues, such as a high risk of pressure sores. Uses the latest medical grade silicone gel technology allowing pressure to be evenly distributed.

The gel conforms to the shape of the body, equalises to body temperature, allows air to flow easily & is totally odourless & hypoallergenic.

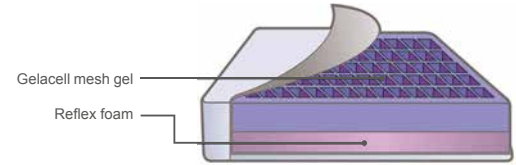

Celliform Pressure Risk **MEDIUM** → **HIGH**

For those sitting for long periods of time with specific comfort issues, such as a high risk of pressure sores & shear forces.

Gelacell's unique grid design eliminates pressure points, contouring in response to the transfer of weight, evenly distributes pressure & reduces heat absorption, keeping the seat cooler & fresher.

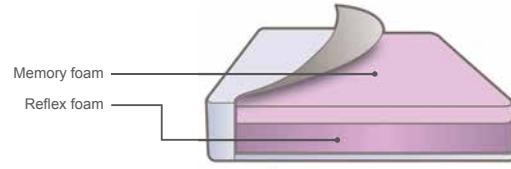

Viscoform Pressure Risk **LOW** → **MEDIUM**

For those who have good posture & mobility, but are seated for periods longer than one hour, require pressure relief & supported comfort.

High density foam provides support, whilst a top layer of memory foam allows submersion into the cushion, providing a large surface area to reduce pressure levels.

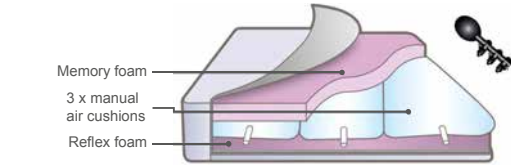

Airform Pressure Risk **HIGH**

For those who have good posture, but are unable to alter their position easily & require high level pressure care.

This cushion provides the benefits of an air cushion, however without the sensation of alternating changes in air pressure.

Suitable for users 40 - 127kg.

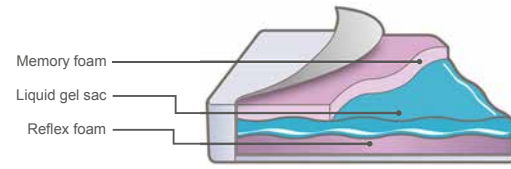

Liquiform Pressure Risk **MEDIUM** → **HIGH**

For those who have good posture & mobility, but are seated for long periods of time, require pressure relief & supported comfort. Excellent for people with little fatty tissue.

High density foam provides support, topped with layers of fluid liquid gel & memory foam to provide high levels of pressure relief. The liquid gel helps to dissipate heat, whilst constantly adapting to movement.

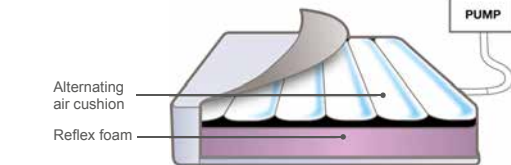

Dynaform Pressure Risk **VERY HIGH**

For those at very high risk of developing pressure sores, or have a history of sores, where the priority is to prevent further pressure damage.

Dynaform is a dynamic alternating air cushion, which constantly changes air levels within its cells to recreate the effect of pressure relieving & prevent pressure build up.

- Air cell features
- 6 dynamic cells 10cm wide
 - 3 cell cycle repeated every 9 minutes

Suitable for users 40 - 121kg.

Please note the Dynaform cushion does need an electric supply at all times to operate.

Back Cushion Options

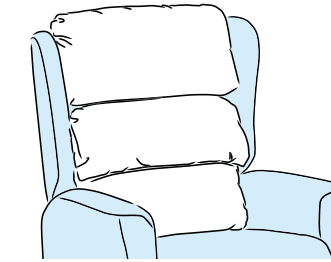

Waterfall Back Cushion
Individual waterfall cushions, fully adjustable to accommodate maximum postural support

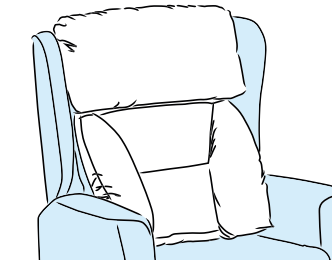

Comfort Lateral Back Cushion
Soft fibre filled removable lateral cushion for lower back & side lumbar support, without feeling restricted

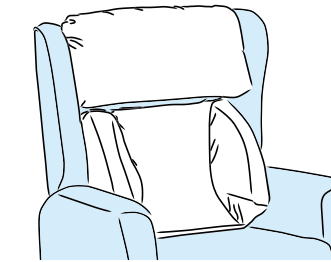

Support Lateral Back Cushion
A foam filled back providing firmer lateral support with a soft fibre filled headrest

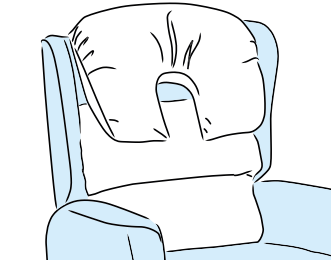

Large Profile Headrest with Waterfall Back
For those with limited head control & requiring a soft adjustable lumbar support

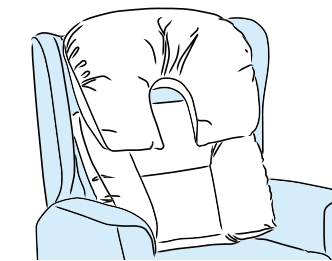

Large Profile Headrest with Comfort Lateral Back
For those with limited head control & requiring soft lateral support without feeling restricted

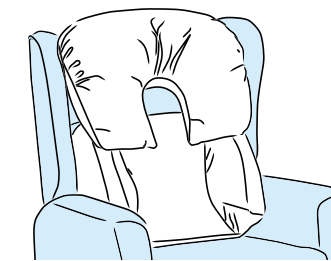

Large profile headrest with Support Lateral Back
For those with limited head control, requiring firm foam lateral lumbar & midline support

Headrest Options

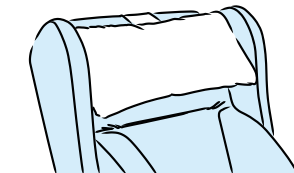

Head Pillow



Head Roll



Small Profile Headrest



Large Profile Headrest



Midline Headrest

Table with Wireless Charging

360-degree rotation & angle adjustable table with a wipe clean surface. Supports Qi wireless charging & fitted with a USB socket. Removable magnetic bar provides support & ensures correct positioning on the wireless receiver coil, wipe clean surface (w 345 x h 245mm)

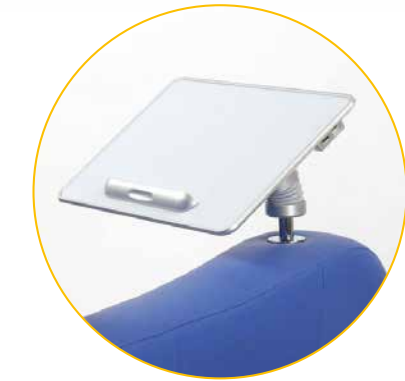



5RE/OC/PORT/VVDEL

Overnight Chair - Portland, Three Position

Features

- Multi-functional compact chair that provides comfortable seating by day, transforming into a bed by night
- Suitable for use in maternity units, children's wards, relative's rooms, hospices & care homes
- Provides visitors with a comfortable place to sleep during longer visits
- Chair is pulled out in three motions to a bed
 - Chair
 - Lounge Chair
 - Bed
- Upholstered using flame retardant antimicrobial vinyl
- Easiform reflex foam provides comfort when sitting or sleeping
- 50mm swivel braking castors
- Maximum capacity 160kg

Dimensions (w x d x h)

- Overall Dimensions - 870 x 840 x 870mm (when open overall bed length is 2060mm)
- Seat - 690 x 540mm at Height 410mm

Standard Colours

- Vinyl - Delft
- Vinyl & Patterned Fabric - Vinyl Lavendel & Savanna Lavender



- Delivery to Chosen Location
- Unwrapping & Removal of Packaging
- Product Positioning & Set-Up
- Full Demonstration of Use to Staff

Alternative colours available at additional cost. Change suffix 'VVDEL' on the product code with any of the following i.e. Portland, Three Position in Olive - 5RE/OC/PORT/VVOLI

Vinyl - Spradling Valencia C5



Item	Description	Weight
5RE/OC/PORT/VVDEL	Three Position, Vinyl Delft	61.5kg
5RE/OC/PORT/VVLAWSAVL	Three Position, Vinyl Lavendel & Savanna Lavender	61.5kg



5RE/OC/PORT/VVLAWSAVL

5RE/OC/PORT/VVTUR



5ZETA2/B/LC/FCT



Soft Seating - Zeta, Modular

Features

- BS EN 16139: 2013 Level 2. Furniture. Strength, durability & safety. Requirements for non-domestic seating
- Zeta is a stylish, fully modular range of soft seating based around eight standard elements suitable for use in seating environments, ranging from reception areas, breakout spaces to waiting areas & cafeterias
- FSC® certified wood core, constructed from 18mm boards
- Traditional webbed seat for additional comfort & durability
- High density CMHR foam
- Vinyl or fabric upholstery
 - Vinyl - Fire retardant & antimicrobial
 - Fabric - Fire retardant
- Chrome finish legs
- Arms available on single & double units with backs
- Backs are available with a raised feature to allow fluid run off (overall height 810mm)
- Maximum capacity
 - Single - 146kg

Options

- RA - Right Arm
- LA - Left Arm
- 2A - Left & Right Arms

Replace suffix on the product code with any of the following to select your colour i.e. Single Unit in Cobalt - 5ZETA1/FCT

Vinyl - Ambla New Richmond in Colour



Fabric - Camira Advantage

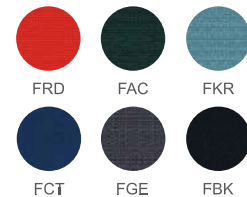

Item	Description	Overall Dimensions (w x d x h)	Seat Height	Seat Depth	Weight
5ZETA1	Single Unit	650 x 650 x 415mm	415mm	650mm	12.0kg
5ZETA2	Double Unit	1300 x 650 x 415mm	415mm	650mm	22.0kg
5ZETA1/B	Single Unit with Back	650 x 650 x 765mm	415mm	485mm	16.5kg
5ZETA2/2B	Double Unit with Back	1300 x 650 x 765mm	415mm	485mm	31.0kg
5ZETA1/CO	Single Unit with Corner	650 x 650 x 765mm	415mm	485mm	16.5kg
5ZETA2/B/RC	Double Unit with Right Corner & Left Back	1300 x 650 x 765mm	415mm	485mm	35.5kg
5ZETA2/B/LC	Double Unit with Left Corner & Right Back	1300 x 650 x 765mm	415mm	485mm	35.5kg
5ZETAQ	Quarter Segment	650 x 650 x 415mm	415mm	650mm	12.0kg
5ZETAH	Half Segment	1300 x 650 x 415mm	415mm	650mm	23.0kg
5ZETAH/B	Half Segment with Back	1300 x 650 x 765mm	415mm	485mm	25.0kg
5ZETAC45	45 Degree Curve	950 x 650 x 415mm	415mm	650mm	11.5kg
5ZETAC45/B	45 Degree Curve with Back	950 x 650 x 765mm	415mm	485mm	16.5kg
5ZETAC90	90 Degree Curve	1625 x 650 x 415mm	415mm	650mm	22.0kg
5ZETAC90/B	90 Degree Curve with Back	1625 x 650 x 765mm	415mm	485mm	32.0kg
5ZETA930C	Single Corner Unit	930 x 650 x 765mm	415mm	650mm	28.0kg



5ZETA1/B/RA/FRD

ZETA1/B/FRD

5ZETA1/B/LA/FRD

To arrange a site visit
please contact us
+44 (0)1258 484455



5ZETA1/B/FGE



Visitor & Waiting Room Seating - Mata Chairs

Features

- BS EN 1729-1: Part 1 & 2: 2015 (functional dimensions & safety requirements)
- BS 4875: Part 1: 2001 Test Level 4 (strength & durability)
- BS 7945: 1999 (stability)
- Available with...
 - Four legs
 - Sled base
- Moulded polypropylene shell available in seven colours
- Silver finish four leg
- Chrome finish sled base
- Four leg chair stackable five high
- Maximum capacity 120kg

Replace suffix on the product code with any of the following to select your colour i.e. Four Leg Chair in Olive - 5SM6L/SOE

Plastic Shell



Item	Description	Overall Dimensions (w x d x h)	Seat Height	Weight
5SM6L	Four Leg	500 x 490 x 805mm	460mm	5.0kg
5SL6	Sled Base	510 x 570 x 805mm	460mm	7.0kg

Visitor & Waiting Room Seating - Prima Chairs

Features

- BS EN 16139: 2013 Level 2 (strength, durability & safety)
- BS 4875: Part 1: 2001 Test Level 4 (strength & durability)
- BS 7945: 1999 (stability)
- Certified for use up to 203kg
- Choice of vinyl, fabric upholstery or polypropylene seat & back
 - Vinyl - Fire retardant & antimicrobial
 - Fabric - Fire retardant
- Stable four leg design
- Black finish tubular frame
- Stacks up to ten high (transporter available)
- Built-in linking system (optional extension links)
- Maximum capacity 203kg

Replace suffix on the product code with any of the following to select your colour i.e. Four Leg Chair in Cobalt - 5301/FCT

Vinyl - Ambla New Richmond in Colour



Fabric - Camira Advantage



Item	Description	Overall Dimensions (w x d x h)	Seat Height	Weight
5301	Four Leg	520 x 580 x 800mm	485mm	8.0kg
5301/A	Four Leg, Arm Rests	620 x 580 x 800mm	485mm	10.0kg



5301/A/FRD



5301/VLI



5NOVA/1/VBB



Waiting Room Seating - Nova, Tub

Features

- Nova single & double tub chairs are suitable for a wide range of seating environments, ranging from cafeterias to waiting areas
- FSC® certified wood core with moulded deep CMHR seat cushions
- Vinyl or fabric upholstery
 - Vinyl - Fire retardant & antimicrobial
 - Fabric - Fire retardant
- Chrome finish legs
- Maximum capacity
 - Single - 146kg
 - Double - 292kg

Replace suffix on the product code with any of the following to select your colour i.e. Double Seat in Cobalt - 5NOVA/3/**FCT**

Vinyl - Ambla New Richmond in Colour



Fabric - Camira Advantage

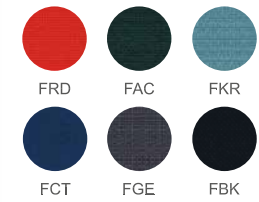

Item	Description	Overall Dimensions (w x d x h)	Seat Height	Weight
5NOVA/1	Nova - Tub, Single Seat	680 x 680 x 800mm	450mm	16.0kg
5NOVA/2	Nova - Tub, Double Seat	1360 x 680 x 800mm	450mm	31.0kg

Waiting Room Seating - Horizon, Beech Frame

Features

- Horizon chairs, sofas & tables are designed to suit a variety of waiting & occasional seating areas
- Beech frame with plywood seat shells
- Arms assist positioning from standing & seated positions
- Vinyl or fabric upholstery
 - Vinyl - Fire retardant & antimicrobial
 - Fabric - Fire retardant
- Fixed seat, with a loose back cushion to assist cleaning
- Back cushion has a zipped cover, allowing for easy replacement if damaged
- Maximum capacity
 - Single chair - 146kg
 - Two seater sofa - 120kg per seat
 - Three seater sofa - 120kg per seat

Replace suffix on the product code with any of the following to select your colour i.e. Two Seater Sofa with Arms in Cobalt - 5HORI/2/A/**FCT**

Vinyl - Ambla New Richmond in Colour



Fabric - Camira Advantage

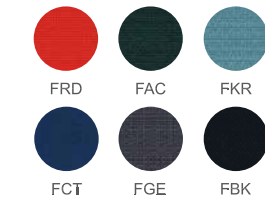

5HORI/2/A/FCT

Item	Description	Overall Dimensions (w x d x h)	Seat Height	Weight
5HORI/1/A	Horizon - Easy Chair, Arms	750 x 650 x 800mm	450mm	19.0kg
5HORI/2/A	Horizon - Two Seater Sofa, Arms	1350 x 650 x 800mm	450mm	33.0kg
5HORI/3/A	Horizon - Three Seater Sofa, Arms	1950 x 650 x 800mm	450mm	47.0kg



5PF333/FCT



5PF332/SBK



Waiting Room Seating - Prima Beam

Features

- Prima beam is suitable for all environments requiring durable & robust waiting room seating solutions
- Certified for use up to 32 stone (203kg) per seat
- Available as...
 - Fixed Seat
 - Tip Up Seat (must be fixed to the floor)
- Choice of vinyl, fabric upholstery or polypropylene seat & back
 - Vinyl - Fire retardant & antimicrobial
 - Fabric - Fire retardant
- Black finish beam & legs
- Drilled for floor fixing (fixings not supplied)
- Maximum capacity 203kg per seat

Options

- 510065 - Armrest (x1)

Replace suffix on the product code with any of the following to select your colour
i.e. Fixed Beam Seat, Two Seat in Cobalt - 5PF332/**FCT**

Vinyl - Ambla New Richmond in Colour

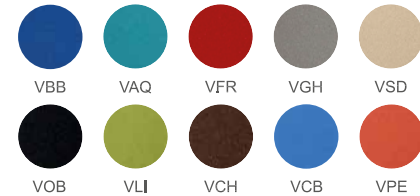

Fabric - Camira Advantage

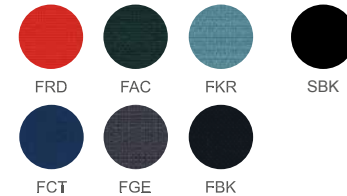

Plastic Shell

Fixed Seat Beam

Item	Description	Overall Dimensions (w x d x h)	Seat Height	Weight
5PF332	Two Seat	1200 x 560 x 790mm	480mm	20.0kg
5PF333	Three Seat	1800 x 560 x 790mm	480mm	25.0kg
5PF334	Four Seat	2400 x 560 x 790mm	480mm	30.0kg
5PF335	Five Seat	3000 x 560 x 790mm	480mm	35.0kg



5PT338/FRD
Shown with 510065 (optional arms sold individually) - contact us for details



5PT336/VOB

Tip-Up Seat Beam

Item	Description	Overall Dimensions (w x d x h)	Seat Height	Weight
5PT336	Two Seat	1200 x 560 x 480mm	490mm	20.0kg
5PT337	Three Seat	1800 x 560 x 480mm	490mm	25.0kg
5PT338	Four Seat	2400 x 560 x 480mm	490mm	30.0kg
5PT339	Five Seat	3000 x 560 x 480mm	480mm	35.0kg



5VOYAGE3/510068/510069/VBB
Shown with Seat & Back Pads

Waiting Room Seating - Voyage, Beam

Features

- BS EN 16139: 2013 Level 2. Furniture. Strength, durability & safety. Requirements for non-domestic seating
- Voyage beam is suitable in heavy usage waiting room environments
- Cast aluminium polished leg frames
- One piece metal seat face with cast aluminium polished edges
- Optional...
 - Floor fixing plates
 - Upholstered seat & back pads
 - Arms
 - Tables - Maple finish, rectangular / round with swivel linking joint
- Maximum capacity 203kg per seat

Options

- 510046 - Floor Fixing Plates - Mild Steel, Painted
- 510068 - Seat Pad - Upholstered, Vinyl
- 510069 - Back Pad - Upholstered, Vinyl
- 5VOYAGE ARM - Arm - Cast Aluminium, Polished
- 5VOYAGECT - Table - Round, Maple Finish with Swivel Linking Joint
- 5VOYAGERT - Table - Rectangle, Maple Finish

Seat & Back Pad Vinyl

Replace suffix on the product code with any of the following to select your colour
i.e. Beam, Two Seat, Seat Pad in Bristol Blue - 5VOYAGE2/510068/VBB

Vinyl - Ambla New Richmond in Colour

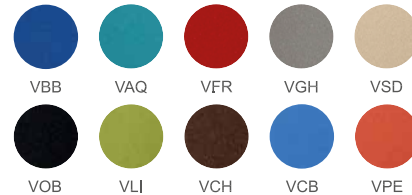

Item	Description	Overall Dimensions (w x d x h)	Seat Height	Weight
5VOYAGE2	Voyage - Beam, Two Seat	1300 x 690 x 770mm	345mm	27.5kg
5VOYAGE3	Voyage - Beam, Three Seat	1900 x 690 x 770mm	345mm	38.5kg
5VOYAGE4	Voyage - Beam, Four Seat	2473 x 690 x 770mm	345mm	49.5kg



5VOYAGE2/510068/510069/VFR
Shown with Seat & Back Pads



5VOYAGERT
Table - Rectangle, Maple Finish



5VOYAGECT
Table - Round, Maple Finish
with Swivel Linking Joint

5VOYAGE2/510068/510069/VPE
Shown with Seat & Back Pads



Tech Chairs

Features

- Vinyl or fabric upholstery
 - Vinyl - Fire retardant & antimicrobial
 - Fabric - Fire retardant
- Black polypropylene five star base
- Models
 - Medium/High - Foot ring & glides
 - Low - Free wheeling castors
- Black gas lift with pneumatic seat height adjustment
- Two lever mechanism
- Maximum load 120kg

Options

- 5BLSTC - Brake loaded castors

Replace suffix on the product code with any of the following to select your colour i.e. High Chair in Peach - 5TC101/**VPE**

Vinyl - Ambla New Richmond in Colour

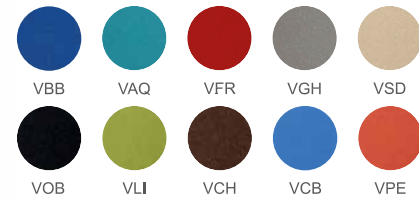

Fabric - Camira Advantage

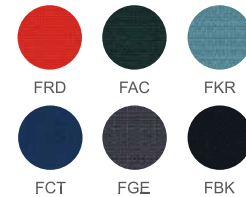

Item	Description	Overall Dimensions (w x d x h)	Seat Height Adjustment	Weight
5TC103	Low	670 x 670 x 890-1090mm	440-580mm	13.0kg
5TC102	Medium	710 x 710 x 950-1210mm	520-710mm	14.0kg
5TC101	High	710 x 710 x 980-1320mm	570-820mm	14.0kg

Tech Stools

Features

- Vinyl or fabric upholstery
 - Vinyl - Fire retardant & antimicrobial
 - Fabric - Fire retardant
- Black polypropylene five star base
- Models
 - Medium/High - Foot ring & glides
 - Low - Non-braking castors
- Black gas lift with pneumatic seat height adjustment
- Maximum load 120kg

Options

- 5BLSTC - Brake loaded castors

Replace suffix on the product code with any of the following to select your colour i.e. Low Stool in Kingfisher - 5TC110/**FKR**

Vinyl - Ambla New Richmond in Colour



Fabric - Camira Advantage

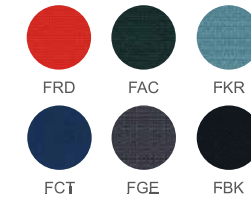

Item	Description	Overall Dimensions (w x d x h)	Seat Height Adjustment	Weight
5TC110	Low	670 x 670 x 440-570mm	440-570mm	8.0kg
5TC109	Medium	670 x 670 x 570-690mm	570-690mm	10.0kg
5TC108	High	670 x 670 x 650-810mm	650-810mm	10.0kg





5PU4



5PU5



5PU6

Industrial
Technical

PU Tech Chairs

Features

- Soft touch black polyurethane seat & back
- Black polypropylene five star base
- Models
 - Medium/High - Foot ring & glides
 - Low - Castors
- Black gas lift with pneumatic seat & back rest height adjustment
- Permanent contact back
- Maximum capacity 120kg

Item	Description	Overall Dimensions (w x d x h)	Seat Height Adjustment	Weight
5PU6	Low, Castors	670 x 670 x 750-980mm	430-570mm	13.0kg
5PU5	Medium, Foot Ring & Glides	710 x 710 x 830-1120mm	510-700mm	14.0kg
5PU4	High, Foot Ring & Glides	710 x 710 x 910-1270mm	580-840mm	14.0kg

PU Tech Stools

Features

- Soft touch black polyurethane seat
- Black polypropylene five star base
- Models
 - Medium/High - Foot ring & glides
 - Low - Castors
- Black gas lift with pneumatic seat height adjustment
- Maximum capacity 120kg

Industrial
Technical

5PU153



5PU152



5PU151

Item	Description	Overall Dimensions (w x d x h)	Seat Height Adjustment	Weight
5PU153	Low, Castors	670 x 670 x 410-540mm	410-540mm	8.0kg
5PU152	Medium, Foot Ring & Glides	670 x 670 x 470-660mm	470-660mm	10.0kg
5PU151	High, Foot Ring & Glides	670 x 670 x 530-780mm	530-780mm	10.0kg



5TC201



5TC202



5TC203



Laboratory

ESD
Static SafeIndustrial
Technical

Static Safe Tech Chairs

Features

- Hi-Tech ESD (anti-static) fire retardant black fabric upholstery
- Aluminium five star base
- Models
 - Medium/High - Foot ring & glides
 - Low - ESD free wheeling castors
- Chrome gas lift with pneumatic seat & back rest height adjustment
- Permanent contact back
- Supplied with ESD (anti-static) castors or glides
- Maximum capacity 120kg

Options

- Independent seat & back mechanism
- Brake loaded ESD castors

Static Safe Tech Stools

Features

- Hi-Tech ESD (anti-static) fire retardant black fabric upholstery
- Aluminium five star base
- Models
 - Medium/High - Foot ring & glides
 - Low - ESD free wheeling castors
- Chrome gas lift with pneumatic seat height adjustment
- Supplied with ESD (anti-static) castors or glides
- Maximum capacity 120kg

Options

- Brake loaded ESD castors



Laboratory

ESD
Static SafeIndustrial
Technical

5TC209



5TC210



5TC208

Item	Description	Overall Dimensions (w x d x h)	Seat Height Adjustment	Weight
5TC203	Low, Castors	670 x 670 x 890-1090mm	440-580mm	13.0kg
5TC202	Medium, Foot Ring & Glides	710 x 710 x 950-1210mm	520-710mm	14.0kg
5TC201	High, Foot Ring & Glides	710 x 710 x 980-1320mm	570-820mm	14.0kg

Item	Description	Overall Dimensions (w x d x h)	Seat Height Adjustment	Weight
5TC210	Low, Castors	670 x 670 x 386-556mm	386-556mm	10.0kg
5TC209	Medium, Foot Ring & Glides	670 x 670 x 490-680mm	490-680mm	11.0kg
5TC208	High, Foot Ring & Glides	670 x 670 x 540-790mm	540-790mm	11.0kg



5TC304



5TC305



5TC306

FIRE
RETARDANT

Laboratory

ESD
Static SafeSterile
Hygiene

HEPA Filter

Static Safe & Sterile Tech Chairs

Features

- ESD (anti-static) fire retardant & antimicrobial black vinyl upholstery
- Aluminium five star base
- Models
 - Medium/High - Foot ring & glides
 - Low - Castors
- Chrome gas lift with pneumatic seat & back rest height adjustment
- Supplied with ESD (anti-static) castors or glides
- HEPA filter
- Maximum capacity 120kg



HEPA filter

Item	Description	Overall Dimensions (w x d x h)	Seat Height Adjustment	Weight
5TC306	Low, Castors	670 x 670 x 890-1090mm	440-580mm	13.0kg
5TC305	Medium, Foot Ring & Glides	710 x 710 x 950-1210mm	520-710mm	14.0kg
5TC304	High, Foot Ring & Glides	710 x 710 x 980-1320mm	570-820mm	14.0kg

Static Safe & Sterile Tech Stools

Features

- ESD (anti-static) fire retardant & antimicrobial black vinyl upholstery
- Aluminium five star base
- Models
 - Medium/High - Foot ring & glides
 - Low - Castors
- Chrome gas lift with pneumatic seat height adjustment
- Supplied with ESD (anti-static) castors or glides
- Maximum capacity 120kg



Laboratory

ESD
Static SafeSterile
Hygiene

HEPA Filter

FIRE
RETARDANT

5TC310



5TC309



5TC308

Item	Description	Overall Dimensions (w x d x h)	Seat Height Adjustment	Weight
5TC310	Low, Castors	670 x 670 x 386-556mm	386-556mm	10.0kg
5TC309	Medium, Foot Ring & Glides	670 x 670 x 490-680mm	490-680mm	11.0kg
5TC308	High, Foot Ring & Glides	670 x 670 x 540-790mm	540-790mm	11.0kg



Medical Grade Clean Room Tech Chairs

Features

- Medical grade fire retardant & antimicrobial black vinyl upholstery
- Aluminium five star base
- Models
 - Medium/High - Foot ring & glides
 - Low - Castors
- Chrome gas lift with pneumatic seat & back rest height adjustment
- HEPA filter
- Maximum capacity 120kg

Options

- Independent seat & back mechanism
- Brake loaded castors



5TC311



5TC312



5TC313



HEPA filter

Item	Description	Overall Dimensions (w x d x h)	Seat Height Adjustment	Weight
5TC313	Low, Castors	670 x 670 x 890-1090mm	440-580mm	13.0kg
5TC312	Medium, Foot Ring & Glides	710 x 710 x 950-1210mm	520-710mm	14.0kg
5TC311	High, Foot Ring & Glides	710 x 710 x 980-1320mm	570-820mm	14.0kg

Medical Records Trolleys



www.bristolmaid.com



Sepsis Trolleys

Sepsis Trolleys 352
Options 353



Electronic Push Button Lock



High Security Bolt Lock

Sepsis Trolleys

Features

- Trolleys designed for use when treating Sepsis
- Supports delivery of 'The Sepsis Six' with clearly defined locations for equipment used in each of the stages
- Door/s fitted with either:
 - Electronic (battery operated) Push Button Lock - Customer can set their own separate user, master, submaster & technician access codes
 - High Security Bolt Lock - Supplied with two keys
- Trolleys supplied with door shelves (useful storage for antibiotics etc) and an A4 document holder
 - Single Door - 2 x door shelves / 1 x A4 document holder
 - Double Door - 5 x door shelves / 1 x A4 document holder
- Six labelled drawers (Oxygen / Blood Cultures / Intravenous Antibiotics / Intravenous Fluid / Haemoglobin & Lactates / Urine Measurement)
- Optional 'Sharps Box Holder' or 'Universal Sharps Box Bracket Mounting Plate' (fits to the l/h side of the trolley)
- Sharps Box Holder - Accepts up to seven litre capacity sharps boxes (customer to fit - fixings supplied)
- Universal Sharps Box Bracket Mounting Plate - Compatible with (customer to supply the plastic brackets & fit - fixings supplied)
 - Daniels Healthcare
 - POUDS® Wall-Bracket (up to 5L) - SHARPSGUARD® mini, 1, 2.5, 3.75, 5 & com plus
 - POUDS® Wall-Bracket (7L & above) - SHARPSGUARD® 7, 11.5 & 22
 - Frontier (Sharpsafe) - 2, 3, 4 & 7
 - Sharpak Healthcare - Sharpak 18, 35, 60, 120 & 220 PLUS
- Upper work surface
- Push handles incorporate integral buffers
- 125mm polymer swivel castors
- When not in use, trolleys storing medicines should be secured to the wall. See option MT/1/6F Security Clamp

Dimensions (w x d x h)

- Single Trolley: 512 x 542 x 1072mm
- Double Trolley: 712 x 542 x 1072mm
- Drawers (internal)
 - Single Width Drawer: 338 x 297 x 115mm
 - Double Width Drawer: 538 x 297 x 115mm

Standard Colours

- Paint - Grey
- Work Surface - Orange

High Security Bolt Lock	Electronic Push Button Lock	Description	Weight
SEPS/6/HSB	SEPS/6/EPB	Single Door, Six Drawer	53.4kg
SEPD/6/HSB	SEPD/6/EPB	Double Door, Six Drawer	62.2 kg

Sharps Box Holder

Features

- Accepts up to seven litre capacity sharps boxes
- Sharps box secured using a rubber band fitted with a toggle
- Attaches to the left hand side of the unit (customer to fit - fixings supplied)



Sharps box not supplied

Item	Description	Weight
SEP/SBH	Sharps Box Holder	0.38kg

Sharps Box Bracket Mounting Plate - Universal

Features

- Compatible with the following brackets (customer to supply the plastic brackets & fit - fixings supplied)
 - Daniels Healthcare
 - POUDS® Wall-Bracket (up to 5L) - SHARPSGUARD® mini, 1, 2.5, 3.75, 5 & com plus
 - POUDS® Wall-Bracket (7L & above) - SHARPSGUARD® 7, 11.5 & 22
 - Frontier (Sharpsafe) - 2, 3, 4 & 7
 - Sharpak Healthcare - Sharpak 18, 35, 60, 120 & 220 PLUS



Trolleys are compatible with most of the popular UK sharps box support brackets.

**Sharps box & bracket not supplied



Frontier (Sharpsafe)**



Sharpak Healthcare**



Daniels Healthcare Up to 5L**



Daniels Healthcare 7L & Above**

Item	Description	Weight
SEP/USBBMP	Universal Sharps Box Bracket Mounting Plate	0.16kg

Security Clamp

Features

- Allows the trolley to be secured to the 'fabric' of the building
- Requires no additional keys, utilises the trolleys own locking system
- One end is secured to the wall, the 'hook shaped' end is trapped by the door of the trolley when closed and locked
- Recommended wall fitting height 1000mm



Important Note - Security Clamps

It is a UK requirement that when the trolley is not in use it should be secured to the 'fabric of the building'. Not only does this prevent casual theft, i.e. trolleys being pushed to an isolated area and broken into, but also encourages good nursing practice, giving the trolley a 'permanent home'.

'Safe & Secure Handling of Medicines - Royal Pharmaceutical Society, GB- March 2005'

Item	Description	Cable Length	Weight
MT/1/6F	Security Clamp	950mm	0.75kg

Drawer Inserts

Features

- Plastic drawer inserts, height 100mm
- Assists segregation of drawer contents
- Suitable for single & double door trolleys
- Insert supplied with removable & repositionable dividers
 - SEP/DIS - 2 x dividers providing 4 separate areas
 - SEP/DID - 4 x dividers providing 6 separate areas
- Supplied for self-assembly
- Clip on label holders & plastic labels available to assist identification

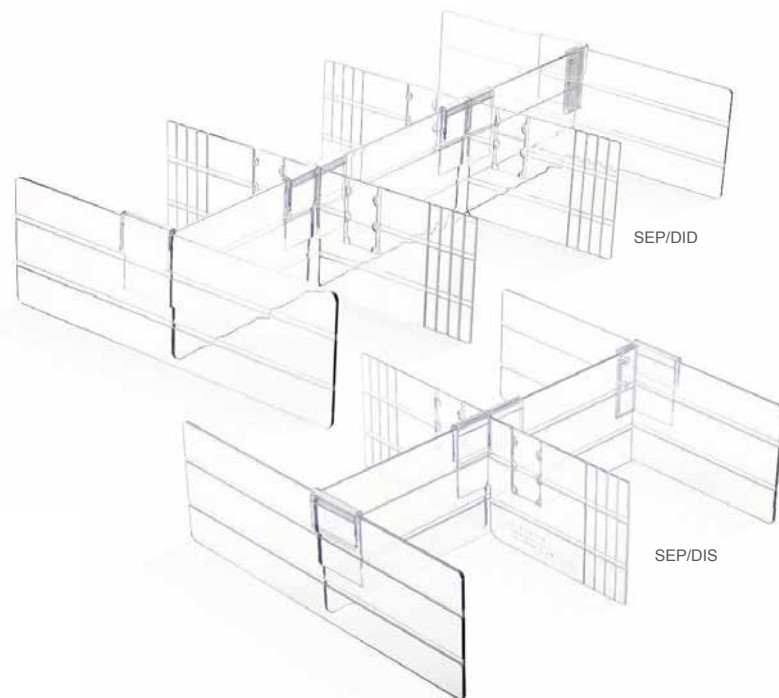

Item	Description	Weight
SEP/DIS	Drawer Insert - Set - Single Door Trolleys	0.49kg
SEP/DID	Drawer Insert - Set - Double Door Trolleys	0.55kg

Label Holders & Labels

Features

- Plastic label holders & labels
- Assists identification of drawer contents
- Label holders snap onto drawer inserts/dividers
- Accepts ISO labels 40 x 60mm (w x h)
- Sold in packs of ten



Item	Description	Weight
SEP/LH	Label Holder	0.006kg
SEP/L	Label	0.001kg

Label - Sepsis Tiger

Features

- Sammy the sepsis tiger label developed for use on Paediatric trolleys
- Compatible with both single & double door trolleys



Item	Description
SEP/TIG01	Label - Sammy Sepsis Tiger

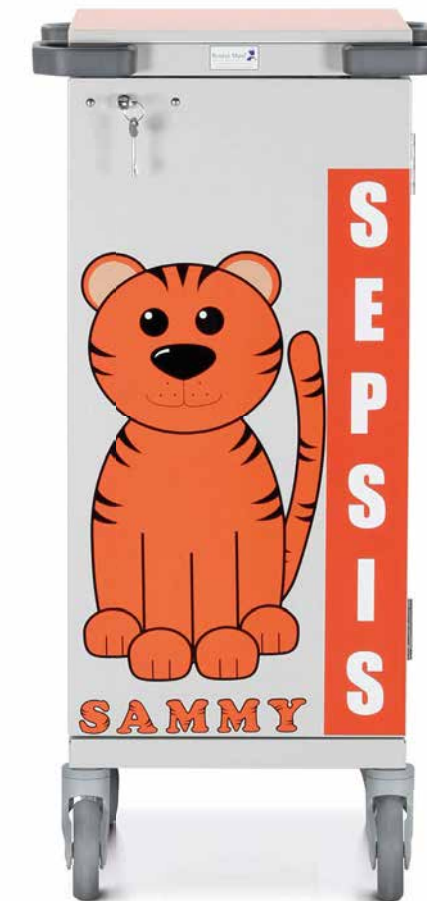

SEPS/6/HSB/SEP/TIG01
Trolley complete with label

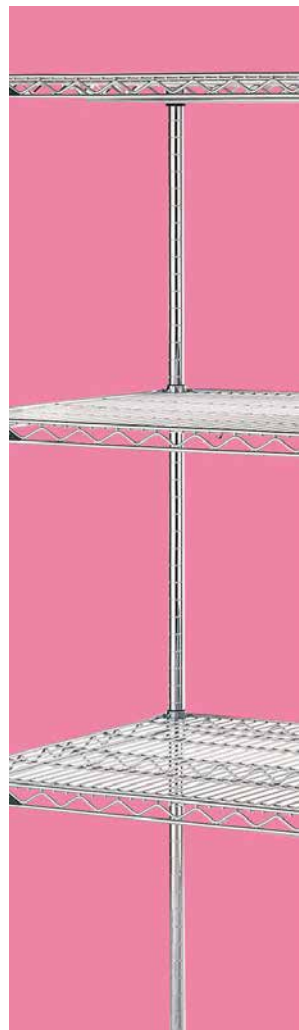

Shelving & Racking Solutions

- Polymer Racking - MetroMax I® 360
- Polymer Racking - MetroMax Q® 362
- Zinc Chrome Racking - Olympic® 364
- High Density Storage - Top-Track® 366

Engineered for a Demanding Environment

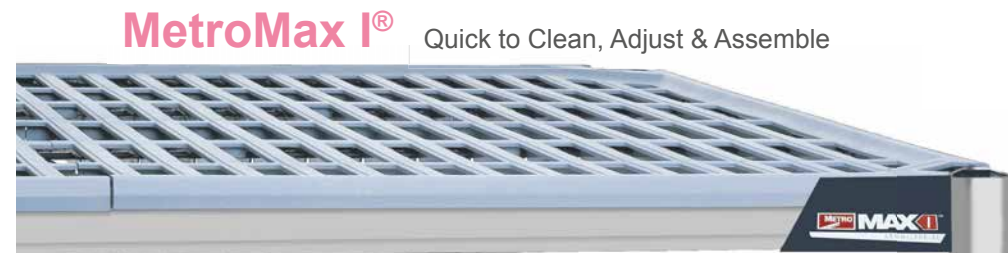

Microban[®]
antimicrobial product protection

Microban[®] antimicrobial product protection helps keep shelves "cleaner between cleanings" by inhibiting the growth of mold, mildew, fungus and bacteria that cause odors and stains on the shelf surface.

Shelving & Racking Solutions

Shelving & Racking Solutions



MetroMax I[®]

- ★★★★★ Corrosion Protection
- ★★★★★ Cleanability
- ★★★★★ Tear Resistance
- ★★★★★ Stability & Mobility

££££ Price

MetroMax Q[®]

- ★★★★★ Corrosion Protection
- ★★★★★ Cleanability
- ★★★★★ Tear Resistance
- ★★★★★ Stability & Mobility

£££ Price

Olympic[®]

- ★ Corrosion Protection
- ★★ Cleanability
- ★★ Tear Resistance
- ★★★★★ Stability & Mobility

£ Price

MetroMax I[®] Quick to Clean, Adjust & Assemble

MetroMax Q[®] Quick to Clean, Adjust & Assemble

Olympic[®] The Economic Wire Storage System



8MX566SG



8MX566MG



Solid Shelves

Polymer Racking - MetroMax I®

Features

- Corrosion proof polymer shelving & racking system
- Polymer shelves with stainless steel corners & a patented no tools shelf release mechanism, adjustable in 25mm increments
- All polymer posts
- Removable easy to clean polymer shelf mats (will fit most dishwashers) available as...
 - Grid Shelves - Open grid design allowing for the free circulation of air, improved visibility & light penetration
 - Solid Shelves - Solid design offering a tear free surface, ideal for the storage of sterilised DIN/ISO trays within theatres
- Built in Microban® antimicrobial product protection, to inhibit the growth of bacteria, mould, mildew & fungus that cause odours
- Available as stationary or mobile units
 - Stationary - Fitted with adjustable feet to allow levelling on uneven floors
 - Mobile - Fitted with 125mm swivel/braking castors
- Shelf Sizes
 - Width - 914, 1066, 1219 & 1524mm*
 - Depth - 610, 457mm*
- Shelf Capacity
 - 914, 1066, 1219mm - 363kg
 - 1524mm - 275kg
- Rack/Unit Capacity
 - Stationary - 907kg
 - Mobile - 339kg
- Label holders available for clear identification of items
- Fully configurable with dividers & ledges
- Lifetime anti corrosion warranty
- Delivered for self-assembly

Stationary Units

4 Shelves - 1590mm High		5 Shelves - 1895mm High		Shelf Size (w x d)
Grid Shelves	Solid Shelves	Grid Shelves	Solid Shelves	
8MX536SG	8MX536SS	85MX536SG	85MX536SS	914 x 610mm
8MX546SG	8MX546SS	85MX546SG	85MX546SS	1066 x 610mm
8MX556SG	8MX556SS	85MX556SG	85MX556SS	1219 x 610mm
8MX566SG	8MX566SS	85MX566SG	85MX566SS	1524 x 610mm

Mobile Units

4 Shelves - 1730mm High		5 Shelves - 2035mm High		Shelf Size (d x w)
Grid Shelves	Solid Shelves	Grid Shelves	Solid Shelves	
8MX536MG	8MX536MS	85MX536MG	85MX536MS	914 x 610
8MX546MG	8MX546MS	85MX546MG	85MX546MS	1066 x 610
8MX556MG	8MX556MS	85MX556MG	85MX556MS	1219 x 610
8MX566MG	8MX566MS	85MX566MG	85MX566MS	1524 x 610

*other sizes available on request



Label Holders

Features

- Allows for clear identification of items
- Snaps onto shelf edge
- Accepts most commercial labels

Dimensions (w x h)

- 102 x 27mm

Standard Colours

- Grey

Item	Description	Weight
89989PX	Label Holder	0.01kg

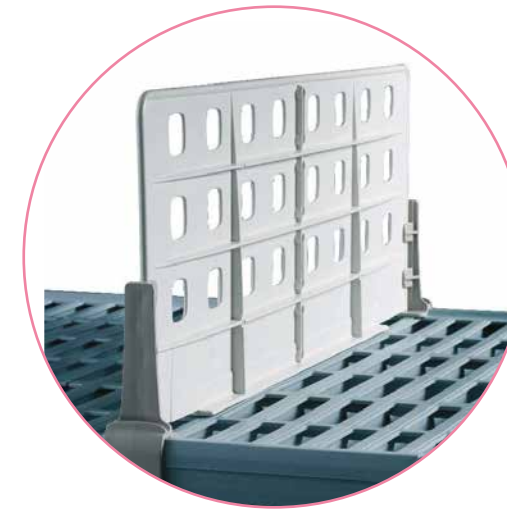

Shelf Divider

Features

- Corrosion proof polymer shelf divider (height 200mm)
- Use to create organised compartments or simply separate shelf contents
- Easily repositioned on grid & solid shelves
- Easy to clean

Dimensions (w x h)

- 610 x 200mm

Standard Colours

- Grey

Item	Description	Weight
8MXD24-8	Shelf Divider	0.7kg



Stackable Shelf Ledges

Features

- Corrosion proof stackable shelf ledge (height 51mm)
- Prevents larger items from protruding or falling
- Compatible with grid & solid shelves
- Easy to clean

Standard Colours

- Chrome

Item	Description	Weight
Side Ledge		
8MXLS24-2S	Side Ledge - 610mm	0.2kg
Rear Ledge		
8MXL36-2S	Rear Ledge - 914mm	0.4kg
8MXL42-2S	Rear Ledge - 1066mm	0.6kg
8MXL48-2S	Rear Ledge - 1219mm	0.6kg
8MXL60-2S	Rear Ledge - 1524mm	0.8kg



8Q566G2



Solid Shelves



8Q566G2M

Polymer Racking - MetroMax Q®

Features

- Epoxy/polymer shelving & racking system
- Epoxy coated shelves & posts with a patented no tools shelf release mechanism, adjustable in 25mm increments
- Removable easy to clean polymer shelves (will fit most dishwashers)
- Open grid design allowing for the free circulation of air, improved visibility & light penetration
- Built in Microban® antimicrobial product protection, to inhibit the growth of bacteria, mould, mildew & fungus that cause odours
- Available as stationary or mobile units
 - Stationary - Fitted with adjustable feet to allow levelling on uneven floors
 - Mobile - Fitted with 125mm swivel/braking castors
- Shelf Sizes
 - Width - 914, 1066, 1219 & 1524mm*
 - Depth - 610, 457mm*
- Shelf Capacity
 - 914, 1066, 1219mm - 363kg
 - 1524mm - 275kg
- Rack/Unit Capacity
 - Stationary - 907kg
 - Mobile - 339kg
- Label holders available for clear identification of items
- Fully configurable with dividers & ledges
- Anti Corrosion warranty
 - Frame & Posts - Fifteen years
 - Mats - Lifetime
- Delivered for self-assembly

Stationary Units

4 Shelves	Shelf Size (w x d)	Height	Weight
8Q536G2	914 x 610mm	1590mm	30.0kg
8Q546G2	1066 x 610mm	1590mm	33.6kg
8Q556G2	1219 x 610mm	1590mm	35.6kg
8Q566G2	1524 x 610mm	1590mm	44.4kg

5 Shelves	Shelf Size (w x d)	Height	Weight
85Q537G2	914 x 610mm	1895mm	36.7kg
85Q547G2	1066 x 610mm	1895mm	41.2kg
85Q557G2	1219 x 610mm	1895mm	43.7kg
85Q567G2	1524 x 610mm	1895mm	54.7kg

Mobile Units

*other sizes available on request

4 Shelves	Shelf Size (w x d)	Height	Weight
8Q536G2M	914 x 610mm	1730mm	34.6kg
8Q546G2M	1066 x 610mm	1730mm	38.2kg
8Q556G2M	1219 x 610mm	1730mm	40.2kg
8Q566G2M	1524 x 610mm	1730mm	49.0kg

5 Shelves	Shelf Size (w x d)	Height	Weight
85Q537G2M	914 x 610mm	2035mm	41.3kg
85Q547G2M	1066 x 610mm	2035mm	45.8kg
85Q557G2M	1219 x 610mm	2035mm	48.3kg
85Q567G2M	1524 x 610mm	2035mm	59.3kg



Label Holders

Features

- Allows for clear identification of items
- Snaps onto shelf edge
- Accepts most commercial labels

Dimensions (w x h)

- 102 x 27mm

Standard Colours

- Grey

Item	Description	Weight
8Q04LH	Label Holder	0.01kg

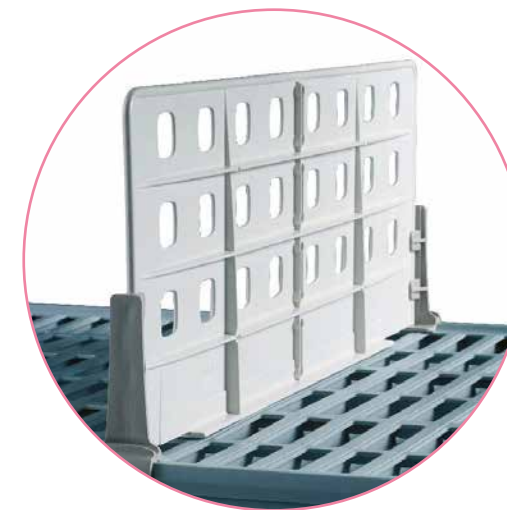

Shelf Divider

Features

- Corrosion proof polymer shelf divider (height 200mm)
- Use to create organised compartments or simply separate shelf contents
- Easily repositioned on grid & solid shelves
- Easy to clean

Dimensions (w x h)

- 610 x 200mm

Standard Colours

- Grey

Item	Description	Weight
8MQD24-8	Shelf Divider	0.7kg



Stackable Shelf Ledges

Features

- Corrosion proof stackable shelf ledge (height 51mm)
- Prevents larger items from protruding or falling
- Compatible with grid & solid shelves
- Easy to clean

Standard Colours

- Chrome

Item	Description	Weight
Side Ledge		
8MQLS24-2S	Side Ledge - 610mm	0.2kg
Rear Ledge		
8MQL24-2S	Rear Ledge - 610mm	0.2kg
8MQL36-2S	Rear Ledge - 914mm	0.4kg
8MQL42-2S	Rear Ledge - 1066mm	0.6kg
8MQL48-2S	Rear Ledge - 1219mm	0.6kg
8MQL60-2S	Rear Ledge - 1524mm	0.8kg



Zinc Chrome Racking - Olympic®

Features

- Zinc Chrome shelving & racking system
- Open wire design shelves allowing for the free circulation of air, improved visibility & light penetration
- Chromate posts & shelves with a patented no tools tapered slit sleeve system that snaps together on each post, adjustable in 25mm increments
- Available as stationary or mobile units
 - Stationary - Fitted with adjustable feet to allow levelling on uneven floor
 - Mobile - Fitted with 125mm swivel/braking castors
- Shelf widths - 914, 1066, 1219 & 1524mm*
- Shelf depths - 610, 457mm*
- Shelf Capacities
 - 914, 1066, 1219mm - 364kg
 - 1524mm - 273kg
- Rack/Unit Capacities
 - Stationary - 907kg
 - Mobile - 339kg
- Label holders available for clear identification of items
- Fully configurable with dividers & ledges
- 1 year performance warranty on shelves and posts
- Delivered for self-assembly

80966C

80966CM

Stationary Units

4 Shelves	Shelf Size (w x d)	Height	Weight
80536C	914 x 610mm	1590mm	30.0kg
80546C	1066 x 610mm	1590mm	33.6kg
80556C	1219 x 610mm	1590mm	35.6kg
80966C	1524 x 610mm	1590mm	44.4kg

5 Shelves	Shelf Size (w x d)	Height	Weight
85O537C	914 x 610mm	1895mm	36.7kg
85O547C	1066 x 610mm	1895mm	41.2kg
85O557C	1219 x 610mm	1895mm	43.7kg
85O967C	1524 x 610mm	1895mm	54.7kg

Mobile Units

4 Shelves	Shelf Size (w x d)	Height	Weight
80536CM	914 x 610mm	1730mm	34.6kg
80546CM	1066 x 610mm	1730mm	38.2kg
80556CM	1219 x 610mm	1730mm	40.2kg
80966CM	1524 x 610mm	1730mm	49.0kg

5 Shelves	Shelf Size (w x d)	Height	Weight
85O537CM	914 x 610mm	2035mm	41.3kg
85O547CM	1066 x 610mm	2035mm	45.8kg
85O557CM	1219 x 610mm	2035mm	48.3kg
85O967CM	1524 x 610mm	2035mm	59.3kg



Label Holders

Features

- Allows for clear identification of items
- Snaps onto shelf edge
- Accepts most commercial labels

Dimensions (w x h)

- 75 x 32mm

Standard Colours

- Grey

Item	Description	Weight
89990P	Label Holder	0.1kg



Shelf Divider

Features

- Keeps shelf contents orderly (height 203mm)
- Pressure fit to hold in place

Dimensions (w x h)

- 610 x 203mm

Standard Colours

- Chrome

Item	Description	Weight
8DD24C	Shelf Divider	0.7kg

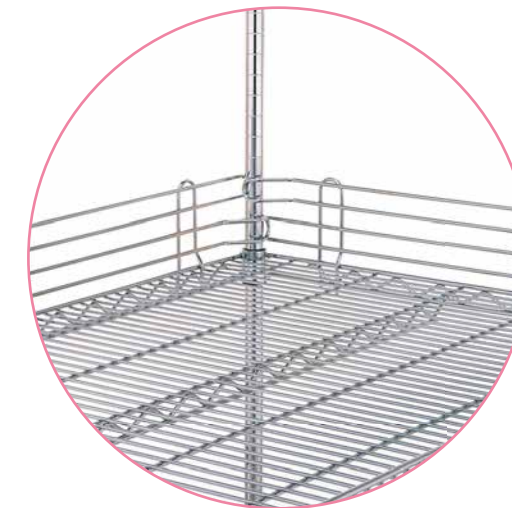

Shelf Ledges

Features

- Prevents items from protruding or falling (height 100mm)
- Pressure fit to hold in place
- Ledges can be stacked

Standard Colours

- Chrome

Item	Shelf Length	Weight
8L24N-4C	610mm	0.90kg
8L36N-4C	914mm	1.25kg
8L42N-4C	1066mm	1.48kg
8L48N-4C	1219mm	1.68kg
8L60N-4C	1524mm	1.81kg



High Density Storage - Top-Track®

Features

- Increases the storage capacity of a given area by up to 50%
- Maximises all available space
- Can eliminate the need to expand a given area through the use of optimised storage
- Creates moveable aisles
- Eliminates hard to reach or 'dead' spaces
- The guide track is positioned above the shelving system
- Aluminium overhead track system acts as a guide for mobile units
- Floors are easy to clean
- Carts & trolleys can easily be manoeuvred into & out of the active aisle
- The guide track compensates for uneven floor surfaces & keeps units in alignment
- Mobile units are designed to accommodate medium-duty applications
- The maximum weight capacity of a Top-Track® mobile unit is 410kg



Top Track Roller

Contact us to arrange
your site-survey
+44 (0)1258 484455



Sterile Container Storage

See Page 396



Sterile Services Equipment

Preparation Tables - Variable Height	370
Preparation Tables - Fixed Height	371
Sterile Supplies Trolleys	372
Trolley Washer Compatible	374

Preparation Tables - Stainless Steel, Variable Height

Features

- Height adjustable preparation tables
- Uses a manual turn handle (folds away when not in use)
 - Static - 715-1015mm
 - Mobile - 812-1112mm
- Available as a static or mobile
 - Static - Fitted with adjustable feet for levelling on uneven floors
 - Mobile - Fitted with 80mm castors, 2 off braking
- 304 grade stainless steel frame & work surface
- Max capacity 70.0kg

Dimensions (w x d x h)

- Static - 1500 x 750 x 715-1015mm
- Mobile - 1500 x 750 x 812-1112mm

Standard Colours

- Stainless Steel



Item	Description	Weight
PT050	Preparation Table - Variable Height, Stainless Steel, Static	49.0kg
PT110	Preparation Table - Variable Height, Stainless Steel, Mobile	53.0kg

Preparation Tables - Stainless Steel, Fixed Height

Features

- Fixed height preparation tables
- Worksurface height 950mm
- Available as a static or mobile
 - Static - Fitted with adjustable feet for levelling on uneven floors
 - Mobile - Fitted with 100mm castors, 2 off braking
- 304 grade stainless steel frame, lower shelf & work surface
- Max capacity 70.0kg

Dimensions (w x d x h)

- Overall Dimensions - 1500 x 750 x 950mm

Standard Colours

- Stainless Steel



Item	Description	Weight
PTS/115	Preparation Table - Fixed Height, Stainless Steel, Static	56.3kg
PTS/115/M	Preparation Table - Fixed Height, Stainless Steel, Mobile	58.8kg



ST/340/UN

AGV Compatible Trolleys
Bristol Maid™ is your ideal partner if you are looking for transport carts for Automated Guided Vehicle (AGV) systems. Through our experienced team we are able to offer solutions for Sterile Supplies, Laundry, Medical Records & Pharmacy distribution.

Sterile Supplies Trolleys - UN3291 Certified

Features

- Independently tested to UN3291 - Certificate of Packaging Performance for the Transportation of Clinical Waste
- Suitable for the transportation of DIN & ISO instrument trays
- Mild steel frame
- Lightweight aluminium cladding, shelves & door/s
- Powder coated for durability
- Locking door/s...
 - Fitted with a flush fitting handle fitted with a CAM lock offering two-point locking (supplied with 2 keys)
 - When opened, doors fold back flat at either end of the trolley*
- Three adjustable shelves, (max 40kg per shelf)
- Shelf size...
 - Small - 534 x 614mm (w x d)
 - Large - 1128 x 614mm (w x d)
- Removable stainless steel drip tray
- Inset push handles at either end of trolley
- Low level bumper rail offers protection to both the trolley & fabric of the building
- Optional tow bar fitting...
 - Tow bar fitted to the front (swivel castor)
 - Antiluce fastener fitted to rear (fixed castor)
 - Tow bar position approx. 360-380mm above floor
 - Recommended max speed 7kph for towed trolleys
- 200mm heavy duty cushioned castors, 2 x fixed, 2 x swivel braking
- Maximum capacity...
 - Small - 84k.0g per trolley
 - Large - 109.0kg per trolley

Dimensions (w x d x h)

- Small - 805 x 774 x 1257mm
- Large - 1399 x 774 x 1257mm

Standard Colours

- Frame - Grey
- Cladding / Shelves / Doors - White



Tow Bar



Drip Tray



ST/690/UN

Item	Description	Weight
Small		
ST/340/UN	Sterile Supplies Trolley - UN3291 Certified, Small	74.5kg
ST/340/UN/T	Sterile Supplies Trolley - UN3291 Certified, Towing, Small	78.5kg
Large		
ST/690/UN	Sterile Supplies Trolley - UN3291 Certified, Large	110.0kg
ST/690/UN/T	Sterile Supplies Trolley - UN3291 Certified, Towing, Large	114.0kg

Sterile Supplies Trolleys - UN3291 Certified, Trolley Washer Disinfector Compatible



STSS/690/UN

Features

- Independently tested to UN3291 - Certificate of Packaging Performance for the Transportation of Clinical Waste
- Compatible with trolley washer disinfectors
- Suitable for the transportation of DIN & ISO instrument trays
- 304 grade stainless steel frame, cladding, shelves & doors
- Natural unpolished finish
- Locking door/s...
 - Fitted with a flush fitting handle fitted with a CAM lock offering two-point locking (supplied with 2 keys)
 - When opened, doors fold back flat at either end of the trolley*
 - Spring loaded plungers hold the doors open, essential when the trolley is being processed in a trolley washer disinfector
- One fixed, two adjustable shelves (max 50kg per shelf)
 - Shelf size - 1227 x 632mm (w x d)
- Stainless steel drip tray...
 - Removable for cleaning
 - Can be located at the rear of the trolley during cleaning, held in position using spring loaded plungers
- Inset push handles at either end of trolley
- High level corner bumpers offer protection to both the trolley & fabric of the building
- Optional tow bar fitting...
 - Tow bar fitted to the front (swivel castor)
 - Antiluce fastener fitted to rear (fixed castor)
 - Tow bar position approx. 360-380mm above floor
 - Recommended max speed 7kph for towed trolleys
- 200mm heavy duty sealed bearing stainless steel castors, 2 x fixed, 2 x swivel braking
- Maximum capacity 136.0kg per trolley

Dimensions (w x d x h)

- 1407 x 762 x 1288mm

Standard Colours

- Stainless Steel - Natural Unpolished

Compatible with
Trolley Washer
Disinfectors



Drip Tray Locates at Rear of Trolley During Cleaning



High Level Corner Bumpers



STSS/690/UN

AGV Compatible Trolleys
Bristol Maid™ is your ideal partner if you are looking for transport carts for Automated Guided Vehicle (AGV) systems. Through our experienced team we are able to offer solutions for Sterile Supplies, Laundry, Medical Records & Pharmacy distribution.

Item	Description	Weight
STSS/690/UN	Sterile Supplies Trolley - Stainless Steel, Trolley Washer/Sterilisation Unit Compatible	131.0kg
STSS/690/UNT	Sterile Supplies Trolley - Stainless Steel, Trolley Washer/Sterilisation Unit Compatible, Towing	137.0kg

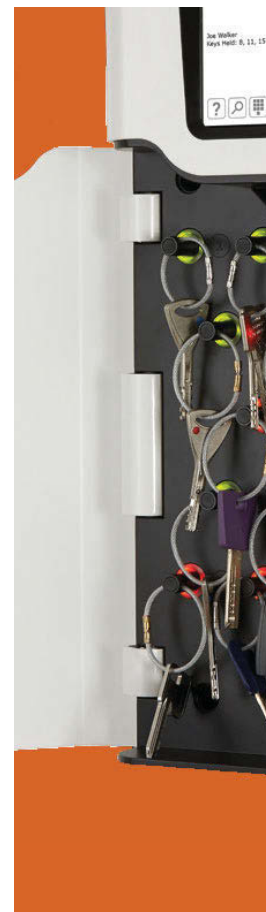

Storage Cupboards Cabinets & Lockers

Storage Cupboards	378
Storage Cabinets	380
First Aid & Clinical Reagent Cabinets	381
Key Cabinets	382
Storage / Personal Effects Lockers	384



SC/L1870/7S5D



Trays



Shelves



Shelves & Dividers

Storage Cupboards - Single Door, 1870mm High

Features

- Single door 1870mm high cupboards
- Single-point locking using a flush fitting CAM lock fitted with a handle (supplied with 2 keys)
- Available with either...
 - Plastic Trays
 - Shelves
 - Shelves & Dividers
- 0.9mm (20 Gauge) mild steel welded construction
- Modular design allows for easy interchange with HTM 63 storage systems

Plastic Trays

- Interchangeable with our popular CT range (post 2016)
- Supplied with 7 x 100mm & 5 x 150mm trays
- Translucent high impact plastic trays feature an integral handle with plastic clip on label cover, (max load per tray 5kg)
- Each cupboard is supplied with perforated coloured label strips (white, blue, green, yellow & red)
- Trays can be subdivided in both length & width using simple slot in dividers (each tray supplied with 2 x long & 2 x short dividers)

Shelves

- Flat shelves adjustable at 50mm increments
- Supplied with 8 x shelves

Shelves & Dividers

- Flat shelves adjustable at 50mm increments
- Removable dividers 100mm high adjustable at 25mm increments
- Supplied with 8 x shelves & 16 x dividers

Dimensions (w x d x h)

- Cupboard
- 500 x 536 x 1870mm

Trays

- Shallow Tray - 355 x 405 x 100mm (internal)
- Deep Tray - 355 x 405 x 150mm (internal)

Standard Colours

- Paint - White

Options

- SC/JK/1870 - Joining Kit
- SC/DIV - Set of 16 Dividers

R/H Hinged	L/H Hinged	Description	Weight
SC/R/1870/7S5D	SC/L/1870/7S5D	Single Door, 1870mm High, Plastic Trays	83.6kg
SC/R/1870/FS	SC/L/1870/FS	Single Door, 1870mm High, Flat Shelves	64.0kg
SC/R/1870/FSD	SC/L/1870/FSD	Single Door, 1870mm High, Flat Shelves & Dividers	74.0kg



SC/L/1870/FSD



SC/L/1870/FS

Joining Kits

Features

- Allows two units to be joined together



Item	Description
SC/JK/1870	Joining Kit

Dividers

Features

- Spare / replacement dividers for SC cupboards supplied with flat shelves & dividers
- Removable 100mm high dividers locate into slots on the shelves (adjustable at 25mm increments)
- Compatible with 1870mm high units



shelf not included

Item	Description
SC/DIV	Set of 16 Dividers



Storage Cabinets - Single & Double Door

Features

- Adjustable & removable shelves
- Flush fitting handle fitted with a CAM lock offering single-point locking (supplied with 2 keys)
- 0.9mm (20 gauge) mild steel welded construction
- Mounting holes in back (fixings not included)
- Modular design allows for easy interchange with HTM 63 storage systems

Standard Colours

- Paint - White



Item	Shelves	Overall Dimension (w x d x h)	Weight
Single Door			
SC020	2	600 x 300 x 600mm	19.5kg
SC025	3	600 x 300 x 900mm	26.0kg
Double Door			
SC040	4	1000 x 300 x 600mm	32.5kg
SC045	6	1000 x 300 x 900mm	45.0kg

Storage Cabinets - First Aid & Clinical Reagents

Features

- Removable shelves
- Flush fitting handle fitted with a CAM lock offering single-point locking (supplied with 2 keys)
- 0.9mm (20 gauge) mild steel welded construction
- Mounting holes in back (fixings not included)
- Supplied with 'First Aid' & 'Clinical Reagents' self-adhesive labels

Dimensions (w x d x h)

- Small - 300 x 200 x 400mm
- Medium - 400 x 200 x 400mm
- Large - 400 x 200 x 600mm

Standard Colours

- Paint - White



Item	Description	Shelves	Weight
GC005	First Aid & Clinical Reagents Cabinet - Small	2	5.0kg
GC010	First Aid & Clinical Reagents Cabinet - Medium	2	6.0kg
GC015	First Aid & Clinical Reagents Cabinet - Large	2	8.0kg



How does it work?

1



Access

User enters unique PIN code to gain access to the cabinet

2



Key Removal

Keys & keysets are individually locked within the cabinet. Green LED's indicate those keys which the user can access. The user cannot remove keys highlighted by the Red LED's which continue to remain locked in place

3



Key Replacement

An amber light indicates the return position for the key

Storage Cabinets - Keys, Traka21

Features

- User, key & access rights administration
- Screen based audit trail & reporting capability or export via USB port
- 21 robust, long-life iFobs with security seals
- 21 locking receptors with LEDs
- Robust & compact aluminium & ABS housing with no exposed hinges or obvious access points
- Manual override & door release functions in case of emergency
- Audible alarms

Operation

- Stand-alone 'Plug & Play' solution with advanced RFID technology
- Capacity for up to 21 keys
- Touchscreen interface
- PIN access to designated keys or keysets which are individually locked in place
- Keys are securely attached using special security seals
- Simple to configure through setup wizard
- No requirement for network connection or PC
- Concealed robust fixing points allow secure wall fixing
- Mains operated (optional battery back-up)

Dimensions (w x d x h)

- 246 x 95 x 427mm

Standard Colours

- Aluminium & ABS - White

Options

- SKR/25 - Security Key Rings (x 25)
- SKR/100 - Security Key Rings (x 100)
- SKB/BAT - Battery Back-Up



Traka21 iFob

Once attached to an iFob with a robust security seal, individual keys or keysets are assigned a specific receptor within the Traka cabinet & locked in place until released by an authorised user

Item	Description	Weight
SKC21/TRAKA	Key Cabinet - TRAKA21	4.0kg

Storage Cabinets - Keys

Features

- Cabinets for the control & tracking of keys
- Available with either a CAM or electronic push button lock
- CAM - Supplied with two keys
- Electronic Push Button - Battery operated
- Adjustable hook bars accommodate different key lengths
- Removable control index for out of hours peace of mind
- Colour coded hook bars & tags ensure quick identification, (both numbered)
- Provided with security seals & loops to secure keys that require evidence of tampering or removal

Standard Colours

- Paint - Grey

Electronic Push Button Lock

- Uses a 10 button keypad and a # button. The # button is hidden beneath the handle when in the locked position
- Easy programming & code change
- Four operating codes with differing levels of authority
 - Master code
 - Sub-master code
 - User code
 - Technician code
- User codes are 4 digits
- Master & sub-master codes are 8 digits
- 15,000 openings on 2 x AAA cells (supplied)
- Low battery warning with failure override using 9v battery across LED's (+/-) & master code

CAM Lock

Item	Key Capacity	Overall Dimensions (w x d x h)	Weight
SKC20	20 Keys	185 x 80 x 260mm	2.0kg
SKC30	30 Keys	215 x 80 x 305mm	3.0kg
SKC35	35 Keys	245 x 80 x 320mm	3.0kg
SKC48	48 Keys	300 x 80 x 355mm	4.0kg
SKC64	64 Keys	300 x 80 x 450mm	5.0kg
SKC100	100 Keys	380 x 80 x 550mm	8.0kg

Electronic Push Button Lock

Item	Key Capacity	Overall Dimensions (w x d x h)	Weight
SKC20/CL	20 Keys	185 x 110 x 260mm	2.0kg
SKC30/CL	30 Keys	215 x 110 x 305mm	3.0kg
SKC35/CL	35 Keys	245 x 110 x 320mm	3.0kg
SKC48/CL	48 Keys	300 x 110 x 355mm	4.0kg
SKC64/CL	64 Keys	300 x 110 x 450mm	5.0kg
SKC100/CL	100 Keys	380 x 110 x 550mm	8.0kg



Alternative colours available

Replace suffix on the product code with any of the following to select your colour i.e. Single Bank with a Green Door - PL080/GD



BD
Blue Door

GD
Green Door



RD
Red Door

YD
Yellow Door



Hasp & Staple Lock



PL080/BD



PL105/GD



PL115/RD



PL145/YD



PL150/BD

Storage Lockers - Personal Effects

Features

- Range of personal effects lockers available in single, double or triple banks in a number of compartment configurations
- Choice of locking options
 - CAM lock (supplied with 2 keys)
 - Hasp & staple (accepts a padlock/not supplied)
- Lock surround incorporates a 25mm round label holder
- Mounting holes provided in back (fixings not included)
- Optional stands & sloping tops

Dimensions (w x d x h)

- Single Bank - 305 x 460 x 1780mm
- Double Bank - 610 x 460 x 1780mm
- Triple Bank - 915 x 460 x 1780mm

Internal Compartments (w x d x h)

- One - 255 x 440 x 1680mm
- Two - 255 x 440 x 815mm
- Three - 255 x 440 x 525mm
- Four - 255 x 440 x 385mm
- Five - 255 x 440 x 295mm

Standard Colours

- Body - Grey
- Doors - Blue

Single Bank

Compartments	1	2	3	4	5
Coat Hook	Yes	Yes	No	No	No
Shelf	Yes	No	No	No	No
Hasp & Staple	PL005/BD	PL010/BD	PL015/BD	PL020/BD	PL025/BD
CAM Lock	PL080/BD	PL085/BD	PL090/BD	PL095/BD	PL100/BD

Double Bank

Compartments	1	2	3	4	5
Coat Hook	Yes	Yes	No	No	No
Shelf	Yes	No	No	No	No
Hasp & Staple	PL030/BD	PL035/BD	PL040/BD	PL045/BD	PL050/BD
CAM Lock	PL105/BD	PL110/BD	PL115/BD	PL120/BD	PL125/BD

Triple Bank

Compartments	1	2	3	4	5
Coat Hook	Yes	Yes	No	No	No
Shelf	Yes	No	No	No	No
Hasp & Staple	PL055/BD	PL060/BD	PL065/BD	PL070/BD	PL075/BD
CAM Lock	PL130/BD	PL135/BD	PL140/BD	PL145/BD	PL150/BD

Stand

Features

- Compatible with single, double & triple bank 1780mm high personal effects lockers
- Keeps lockers clear of the floor assisting cleaning & aiding air-circulation
- Fitted with adjustable feet
- Increases the overall height of the locker by 150mm

Standard Colours

- Stand - Grey



PL910

Item	Description
PL900	Stand - Single Bank
PL905	Stand - Double Bank
PL910	Stand - Triple Bank

Sloping Top

Features

- Compatible with single, double & triple bank 1780mm high personal effects lockers
- Prevents items being stored on the top of the locker & assists cleaning
- Increases the overall height of the locker by 150mm

Standard Colours

- Sloping Top - Grey



PL915 - Sloping top

Item	Description
PL915	Sloping Top - Single Bank
PL920	Sloping Top - Double Bank
PL925	Sloping Top - Triple Bank



Theatre Equipment

Bowl Stands	388
Bucket Stands	391
Instrument Trolleys	392
Mayo Tables & Operating Platforms	394
Suture Storage Trolleys	395
Sterile Container Storage	396



Bowl Stands - Fixed Height

Features

- Seamlessly welded from 304 grade stainless steel for strength & ease of cleaning
- Bowl retaining rings fitted with removable anti-static spiral buffers to support bowls
- Suitable for use with 360mm diameter stainless or polythene bowls (order separately)
- 75mm anti-static castors

Standard Colours

- Stainless Steel

Options

- 2MECO079 - 360mm Diameter, Stainless Steel Bowl
- 2PLCO054 - 360mm Diameter, Polythene Bowl



2MECO079
Stainless Steel Bowl



2PLCO054
Polythene Bowl

Item	Description	Overall Dimensions (w x d x h)	Weight
SBS/2	Bowl Stand - Fixed Height, Double Bowl, Side by Side	735 x 400 x 855mm	6.0kg
SBST/2	Bowl Stand - Fixed Height, Double Bowl, Tiered	400 x 400 x 855mm	5.0kg

Bowl Stands - Variable Height

Features

- Seamlessly welded from 304 grade stainless steel for strength & ease of cleaning
- Height adjustable upright using a handwheel (753-1100mm)
- Bowl retaining ring fitted with removable anti-static spiral buffers to support bowls
- Suitable for use with 360mm diameter stainless or polythene bowls (order separately)
- 50mm polypropylene/thermoplastic rubber twin-wheel castors (1 x anti-static)

Standard Colours

- Stainless Steel

Options

- 2MECO079 - 360mm Diameter, Stainless Steel Bowl
- 2PLCO054 - 360mm Diameter, Polythene Bowl



2MECO079
Stainless Steel Bowl



2PLCO054
Polythene Bowl



SBSA/2



SBSA/1

Item	Description	Overall Dimensions (w x d x h)	Weight
SBSA/1	Bowl Stand - Variable Height, Single Bowl	650 x 650 x 753 -1100mm	4.8kg
SBSA/2	Bowl Stand - Variable Height, Double Bowl	746 x 650 x 753 -1100mm	5.6kg



BO/P/V/D/SP

Bowl Stands - Variable Height, Polyurethane, Easy Clean

Features

- Five leg base with low centre of gravity to assist stability
- 25mm diameter scratch resistant stainless steel upright
- A seamless polyurethane over moulding encases the base providing...
 - A flexible tear & water resistant finish
 - Impact protection to the fabric of the building
 - A shield for the twin wheel castors
 - Smooth edges & contours, allowing for easy & effective cleaning (including steam cleaning)
- Coloured indicator caps provide department identification & segregation, reducing the risk of cross contamination
- Height adjustable upright using a handwheel
 - Single Bowl - 820 - 1125mm
 - Double Bowl - 820 - 1125mm
- Bowl retaining rings fitted with removable anti-static spiral buffers to support bowls
- Suitable for use with 360mm diameter stainless or polythene bowls (order separately)
- 50mm polypropylene/thermoplastic rubber twin wheel castors (1 x anti-static)

Dimensions (w x d x h)

- Single Bowl - 650 x 650 x 820 - 1125mm
- Double Bowl - 746 x 650 x 820 - 1125mm

Standard Colours

- Base - Grey
- Coloured Indicator Cap - Spearmint
- Bowl Retaining Rings - Stainless Steel

Options

- Coloured Indicator Cap - Blue / Green / Red / Yellow
- 2MECO079 - Stainless Steel Bowl
- 2PLCO054 - Polythene Bowl

BL
BlueGR
GreenRD
RedYE
Yellow

Item	Description	Weight
BO/P/V/S/SP	Bowl Stand - Variable Height, Polyurethane, Easy Clean, Single Bowl	9.0kg
BO/P/V/D/SP	Bowl Stand - Variable Height, Polyurethane, Easy Clean, Double Bowl	9.8kg

Bowl Stand - Kickabout, 360mm Diameter

Features

- Seamlessly welded from 304 grade stainless steel for strength & ease of cleaning
- Bowl retaining ring fitted with removable anti-static spiral buffers to support bowls
- Supplied with a 360mm diameter stainless steel bowl
- 75mm anti-static castors

Dimensions (w x d x h)

- 365 x 365 x 235mm

Standard Colours

- Stainless Steel

Options

- 2MECO079 - 360mm Diameter, Stainless Steel Bowl
- 2PLCO054 - 360mm Diameter, Polythene Bowl

Supplied with a
7 litre stainless
steel bowl



SBSL/1

Item	Description	Weight
SBSL/1	Bowl Stand - Kickabout, 360mm Diameter	3.2kg

Bucket Stands - Kickabout, 15-Litre Bucket

Features

- Seamlessly welded from 304 grade stainless steel for strength & ease of cleaning
- Bucket retaining ring fitted with removable anti-static spiral buffers to support the bucket
- Model available fitted with a handle
- Supplied with a 15-litre graduated stainless steel bucket
- 75mm anti-static castors

Dimensions (w x d x h)

- SBKSL/1 - 380 x 380 x 515mm
- SBKSLH/1 - 435 x 435 x 515mm

Standard Colours

- Stainless Steel

Options

- 2MECO081 - 15-litre graduated stainless steel bucket

Supplied
with a 15-litre
graduated
stainless
steel bucket



SBKSLH/1

Item	Description	Weight
SBKSL/1	Bucket Stand - 15 Litre Bucket	5.0kg
SBKSLH/1	Bucket Stand - 15 Litre Bucket, Handle	5.5kg



Fixed Shelves, Sides Down, Stainless Steel, 450mm Deep

Features

- Meets BS4068:1977 Specification for hospital trolleys for instruments, dressings & for anaesthetists' use
- Seamlessly welded from 304 grade stainless steel for strength & ease of cleaning
- Fixed shelves with down turned sides
- Shelf heights 405 & 870mm
- Maximum capacity per shelf 40kg
- 75mm pressed steel non-marking castors (1 x anti-static, 3 x non-anti-static)

Options

- C001 - 80mm, Grey Polymer Castors (2 x braking / 2 x non-braking)
- C002 - 100mm, Grey Polymer Castors (2 x braking / 2 x non-braking)
- C003 - 100mm, Pressed Steel Castors (2 x braking / 2 x non-braking)
- C013 - 75mm, Pressed Steel Castors (4 x braking)
- Drawer Units - Range of sizes / configurations (see page 107)
- DP/C - Infusion Pole & Bracket
- ZP005 - Ring Buffers

Item	Size	Shelf Size (w x d)	Overall Dimensions (w x d x h)	Weight
DTSF/450/2/SD	Small	450 x 450mm	470 x 470 x 870mm	12.0kg
DTSF/600/2/SD	Medium	600 x 450mm	620 x 470 x 870mm	14.5kg
DTSF/750/2/SD	Large	750 x 450mm	770 x 470 x 870mm	18.0kg
DTSF/900/2/SD	X-Large	900 x 450mm	920 x 470 x 870mm	21.0kg

Fixed Shelves, Sides Down, Stainless Steel, 600mm Deep

Features

- Meets BS4068:1977 Specification for hospital trolleys for instruments, dressings & for anaesthetists' use
- Seamlessly welded from 304 grade stainless steel for strength & ease of cleaning
- Fixed shelves with down turned sides
- Shelf heights 405 & 870mm
- Maximum capacity per shelf 40kg
- 100mm pressed steel anti-static non-marking castors

Options

- C002 - 100mm, Grey Polymer Castors (2 x braking / 2 x non-braking)
- C003 - 100mm, Pressed Steel Castors (2 x braking / 2 x non-braking)
- C015 - 100mm, Pressed Steel Castors (4 x braking)
- DP/C - Infusion Pole & Bracket
- ZP005 - Ring Buffers



Item	Size	Shelf Size (w x d)	Overall Dimensions (w x d x h)	Weight
DTSF/66/2/SD	Small	600 x 600mm	620 x 620 x 870mm	17.5kg
DTSF/96/2/SD	Medium	900 x 600mm	920 x 620 x 870mm	24.0kg
DTSF/126/2/SD	Large	1200 x 600mm	1220 x 620 x 870mm	29.6kg

Mayo Tables - Cantilever, Variable Height

Features

- Seamlessly welded frame from 304 grade stainless steel for strength & ease of cleaning
- Available with two castors & skid feet or four castors
- Height adjustment...
 - SS/22/1 - 893-1480mm
 - SS/22/2 - 858-1450mm
- Supplied with a removable stainless steel tray, 512 x 387 x 20mm (w x d x h)
- 50mm polypropylene/thermoplastic rubber twin-wheel anti-static castors

Dimensions (w x d x h)

- SS/22/1 - 641 x 450 x 893-1480mm
- SS/22/2 - 651 x 471 x 858-1450mm

Standard Colours

- Stainless Steel

Supplied with a stainless steel tray



Item	Description	Weight
SS/22/1	Mayo Table - Cantilever, Variable Height, Two Castors & Skid Feet	5.4kg
SS/22/2	Mayo Table - Cantilever, Variable Height, Four Castors	5.8kg

Operating Platforms

Features

- Seamlessly welded frame from 304 grade stainless steel for strength & ease of cleaning
- Aluminium embossed non-slip tread
- Non-slip, anti-static rubber feet
- Max capacity 190kg

Dimensions (w x d x h)

- Small - 400 x 300mm
- Large - 600 x 300mm

Standard Colours

- Stainless Steel



Aluminium embossed non-slip tread



OP/432

Item	Description	Weight
Small		
OP/431	Operating Platform - Small, 150mm High	4.2kg
OP/432	Operating Platform - Small, 200mm High	4.4kg
Large		
OP/631	Operating Platform - Large, 150mm High	6.0kg
OP/632	Operating Platform - Large, 200mm High	6.4kg

Suture Storage Trolleys

Features

- Angled shelves present contents for instant identification & easy access
- Allows logical organisation, eliminates confusion, allowing for easier & faster restocking
- Open wire design minimises dust accumulation, allowing for free circulation of air, improved visibility & light penetration
- No tools shelf adjustment in 25mm increments
- Each trolley supplied with 12 x shelf retainers to assist with segregation of contents
- Delivered flat pack for self-assembly
- 125mm pressed steel castors, 2 off braking

Options

- 89990P - Label Holder, 75 x 32mm
- 8DCR17C - Shelf Retainers



8DC56EC

Item	Description	Overall Dimensions (w x d x h)	Weight
1 x Flat, 4 x Angled Shelves			
8DC15EC	Trolley - Suture Storage, 1 x Flat / 4 x Angled Shelves, 610mm	610 x 457 x 1524mm	46.5kg
8DC35EC	Trolley - Suture Storage, 1 x Flat / 4 x Angled Shelves, 914mm	914 x 457 x 1524mm	49.0kg
8DC55EC	Trolley - Suture Storage, 1 x Flat / 4 x Angled Shelves, 1219mm	1219 x 457 x 1524mm	51.0kg
5 x Angled Shelves			
8DC16EC	Trolley - Suture Storage, 5 x Angled Shelves, 610mm	610 x 457 x 1524mm	50.0kg
8DC36EC	Trolley - Suture Storage, 5 x Angled Shelves, 914mm	914 x 457 x 1778mm	51.5kg
8DC56EC	Trolley - Suture Storage, 5 x Angled Shelves, 1219mm	1219 x 457 x 1778mm	52.5kg



4HH-SCS/S1/2W5T
Shown with BBraun Aesculap
Sterile Containers (not supplied)

Sterile Container Storage

Features

- Fully configurable freestanding modular racking suitable for the safe storage of sterile containers
- Compatible with both blue wrap & rigid containers, up to max 300mm x 600mm (width x depth)
- Containers stored on either...
 - Telescopic shelves
 - Wire grid shelves
- Optional silicone pads offer additional cushioning for containers (suitable with telescopic shelves only)
- Anodised extruded aluminium uprights & cross members
- Bolted construction using high quality moulded fixings provided rigidity & allows the system to be altered easily
- Available as either static or mobile units
 - Static - Adjustable feet allow levelling on uneven floors
 - Mobile - 50/80mm pressed steel castors
- Optional wall mounting brackets allow static units to be fixed securely to the wall, (when units are loaded over 100kg)
- Supplied for self-assembly

Dimensions (w x d x h)

Static

- Single Bay - 394 x 642 x 1940mm
- Double Bay - 737 x 642 x 1940mm

Mobile (50/80mm Castors)

- Single Bay - 394 x 642 x 1996/2035mm
- Double Bay - 737 x 642 x 1996/2035mm

Standard Colours

- Uprights & Cross Members - Anodised Aluminium
- Wire Grids - Polished Stainless Steel
- Telescopic Shelves - Anodised Aluminium
- Plastic Moulding - Green / Grey

Options

- 2HH-7532293 - Wall Mounting Bracket (x1)
- 2HH-7532277 - 10mm Plastic Cover Cap (x1)

Static

Item	Description	Weight
Single Bay		
4HH-SCS/S1/2W5T	Static, Single Bay, 2 x Wire Grid Shelves & 5 x Telescopic Shelves	30.2kg
4HH-SCS/S1/8W	Static, Single Bay, 8 x Wire Grid Shelves	21.4kg
Double Bay		
4HH-SCS/S2/4W10T	Static, Double Bay, 4 x Wire Grid Shelves & 10 x Telescopic Shelves	56.9kg
4HH-SCS/S2/16W	Static, Double Bay, 16 x Wire Grid Shelves	38.0kg

Mobile

Item	Description	Weight
Single Bay		
4HH-SCS/M51/2W5T	Mobile, Single Bay, 2 x Wire Grid Shelves & 5 x Telescopic Shelves	31.1kg
4HH-SCS/M51/8W	Mobile, Single Bay, 8 x Wire Grid Shelves	22.3kg
Double Bay		
4HH-SCS/M52/4W10T	Mobile, Double Bay, 4 x Wire Grid Shelves & 10 x Telescopic Shelves	58.2kg
4HH-SCS/M52/16W	Mobile, Double Bay, 16 x Wire Grid Shelves	39.3kg

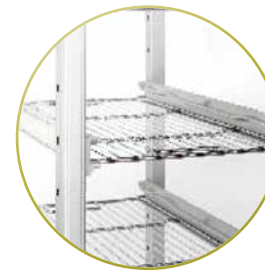

2HH-7532255 - Wire Grid Shelf



2HH-7532335 - Telescopic Shelves



50mm Braking
Pressed Steel Castor



Adjustable Feet



4HH-SCS/M52/4W10T
Shown with BBraun Aesculap
Sterile Containers (not supplied)

4HH-SCS/M51/8W
Shown with BBraun Aesculap
Sterile Containers (not supplied)

4HH-SCS/S2/16W
Shown with BBraun Aesculap
Sterile Containers (not supplied)

Components

- 2HH-7532300-HH - Base Unit (x 1)
- 2HH-7532310 - Extension Unit (x 1)
- 2HH-7532335 - Telescopic Shelf (x 1)
- 2HH-7532255 - Wire Grid Shelf (x 1)
- 2HH-7532356 - Runners (Pair)
- 2HH-7532320 - Adjustable Foot Set (x 4)
- 2HH-7532321 - Adjustable Foot Set (x 2)
- 2HH-7532322 - 50mm Pressed Steel Castors (2 x Braking / 2 x Non-Braking)
- 2HH-7532323 - 50mm Pressed Steel Castors (1 x Braking / 1 x Non-Braking)
- 2HH-7532324 - 80mm Pressed Steel Castors (2 x Braking / 2 x Non-Braking)
- 2HH-7532325 - 80mm Pressed Steel Castors (1 x Braking / 1 x Non-Braking)

Room Design & Installation Service Available
Contact us for more information



Workstations & Speciality Storage

Workstations	400
Storage Units	401
Catheter Storage Units	402



8SXRSENT1



Workstations - Mobile, Polymer, Metro Starsys

Features

- Adaptable workstations
- Available as single, double & triple width units
- Moulded body, drawers & doors from a lightweight polymer that will not rust, chip, dent, peel or corrode
- Laminate worktop (height 914mm)
- 125mm swivel castors, 2 off braking

Standard Colours

- Body/Drawers/Doors - Light Taupe
- Drawer/Door Handles - Slate Blue

Other configurations available. Contact our customer services team to discuss your requirements



8SXRDEMT2



8SXR38MW14

Item	Description	Overall Dimensions (w x d x h)	Weight
8SXRSENT1	Single, Drawers, Overhead Unit	600 x 726 x 2070mm	121.1kg
8SXRDEMT2	Double, Drawers & Door, Overhead Units	1102 x 726 x 2070mm	188.2kg
8SXR40MW10	Double, Drawers, Overhead Units	1102 x 726 x 2070mm	189.0kg
8SXR38MW14	Triple, Drawers & Doors, Overhead Units	1606 x 726 x 2070mm	219.8kg

Storage Units - Mobile, Polymer, Metro Starsys



Features

- Full height storage units
- Available as single, double & triple width units
- Moulded body, drawers & hinged/tambour doors from a lightweight polymer that will not rust, chip, dent, peel or corrode
- 125mm swivel castors, 2 off braking

Standard Colours

- Body/Drawers/Doors - Light Taupe
- Drawer/Door Handles - Slate Blue

Options

- 8SXLABKIT - Drawer/Door Label Holders (x 10)
- 8SXREHAN - Push Handle



8SXR7GS2



8SXRS83MGSTD



8SXR76CM3

Item	Description	Overall Dimensions (w x d x h)	Weight
Drawers & Hinged Doors			
8SXR7GS2	Single, Drawers	578 x 632 x 1990mm	187.7kg
8SXR76CMHD1	Double, Drawers & Hinged Doors	1080 x 709 x 1990mm	159.2kg
8SXR7GS2	Triple, Drawers & Hinged Doors	1669 x 709 x 1990mm	187.8kg
Hinged Doors			
8SXR76CM5	Single, Door	578 x 709 x 1990mm	106.0kg
8SXR76CM3	Double, Doors	1080 x 709 x 1990mm	113.0kg
8SXR7GS3	Triple, Doors	1669 x 709 x 1990mm	158.0kg
Tambour Doors			
8SXRS83MGSTD	Single, Tambour Door	578 x 709 x 2096mm	108.9kg
8SXR83MGSTD	Double, Tambour Doors	1080 x 709 x 2096mm	152.9kg



8SXR7GS2



8SXR83MCATHTD



Catheter Storage Units - Mobile, Polymer, Metro Starsys

Features

- Full height catheter storage units available with either hinged or tambour door/s
- Catheters supported on retractable slides providing easy to access & safe storage
- Available as single & double width units
 - Single - 180 Catheters
 - Double - 360 Catheters
- Moulded body & hinged or tambour doors from a lightweight polymer that will not rust, chip, dent, peel or corrode
- 125mm swivel castors, 2 off braking

Standard Colours

- Body/Drawers/Doors - Light Taupe
- Drawer/Door Handles - Slate Blue

Options

- 8SXCATHHK - Catheter Hooks, (supports 12 catheters)
- 8SXRLABKIT - Drawer/Door Label Holders, (x 10)
- 8SXREHAN - Push Handle

Other configurations available. Contact our customer services team to discuss your requirements



8SXR76MCATH1

Item	Description	Overall Dimensions (w x d x h)	Weight
Hinged Doors			
8SXR83MCATHTD	Single, L/H Hinged Door, 180 x Catheters	578 x 632 x 1990mm	100.1kg
8SXR76MCATH1	Double, R/H & L/H Hinged Door, 360 x Catheters	1080 x 632 x 1990mm	136.3kg
Tambour Doors			
8SXR83MCATHTD	Single, Tambour Door, 180 x Catheters	578 x 709 x 2096mm	109.3kg
8SXR83MCATHTD	Double, Tambour Doors, 360 x Catheters	1080 x 709 x 2096mm	146.1kg

Catheter Storage Units - Stationary, Polymer, Metro Starsys

Features

- Full height catheter storage units available with either hinged or tambour door/s
- Catheters supported on retractable slides providing easy to access & safe storage
- Available as single & double width units
 - Single - 180 Catheters
 - Double - 360 Catheters
- Moulded body & hinged or tambour doors from a lightweight polymer that will not rust, chip, dent, peel or corrode

Standard Colours

- Body/Drawers/Doors - Light Taupe
- Drawer/Door Handles - Slate Blue

Options

- 8SXCATHHK - Catheter Hooks, (supports 12 catheters)
- 8SXRLABKIT - Drawer/Door Label Holders, (x 10)
- 8SXR-FLR - Floor Mounting Kit
- 8SXR72UUFLR - Unit to Unit Filler Kit**
- 8SXR72BKFLR30 - Back to Wall Kit (Half Depth Units)***
- 8SXR72BKFLR - Back to Wall Kit (Full Depth Units)***

**Covers the seam between two adjacent units

***Fills the gap when a unit is pulled away from the wall to be flush with the front of the worktop



8SXR72SCATH1



8SXR80SCATHTD

Item	Description	Overall Dimensions (w x d x h)	Weight
Hinged Doors			
8SXR83MCATHTD	Single, L/H Hinged Door, 180 x Catheters	540 x 594 x 1842mm	75.5kg
8SXR72SCATH1	Double, R/H & L/H Hinged Door, 360 x Catheters	1049 x 594 x 1842mm	143.6kg
Tambour Doors			
8SXR80SCATHTD	Single, Half Depth, Tambour Door, 180 x Catheters	540 x 457 x 2032mm	60.3kg
8SXR72SCATH1	Double, Half Depth, Tambour Door, 360 x Catheters	360 1052 x 457 x 2032mm	113.9kg
8SXR80SCATHTD	Single, Full Depth, Tambour Door, 180 x Catheters	180 540 x 620 x 2032mm	84.4kg
8SXR72SCATH1	Double, Full Depth, Tambour Door, 360 x Catheters	1052 x 620 x 2032mm	140.2kg

A		Caretray Racks	46-49, 56-59	Cover	85	HTM71		Tiered Filing Trolleys	250	Preparation Tables		Rise & Recline Porters Armchairs	323-324	Couch	154-173
Abloy Protec Cliq	115, 140-141	Caretray Trolleys	40-45, 50-55	Fixed Height	85	Carts	192-197	Transfer Trolleys	249-251	Fixed Height	371	Saddle Stools	306	Trolleys	287
Airways / Difficult Intubation Trolley	287	Chart	72-73	Variable Height	84	Distribution Trolleys	197-198	X-Ray Filing Cabinet	251	Variable Height	370	Soft Seating	330-331, 334-335	Airways / Difficult Intubation	287
Alcohol Gel Holders	96	Caretray Options	60-69	Controlled Drug Cabinets	137-139	Open Transfer/Transport Trolleys	199	Melamine Bedside Cabinets	22-29	Pump Stands	208-209	Static Safe Tech Chairs	344	Aluminium Trays	189
Apron Dispensers	94	Carts		Couch		Racks	200-201	Metal Dispensing Trolleys	114	R		Static Safe Tech Stools	345	Caretray	40-45, 50-55
Arm / Leg Rest	162	Basix	276-277	Examination	154-173	Trays, Dividers & Accessories	202-205	Mobile Infusion Stands	208-214	Rack		Static Safe & Sterile Tech Chairs	346	Chart	72
B		Flexline	272-273, 286	Fixed Height	161	Holder		Easy Clean	208-211	Bedpan Drainage	99	Static Safe & Sterile Tech Stools	347	Clean Linen	222, 224-227
Baby		HTM71	192-197	Options	181-183	Alcohol Gel	96	Mild Steel	213	Caretray	46-49, 56-59	Tech Chairs	340	Compact	197
Bath	233	Lifeline	284-285	Steps	163	Bag	290-297	Knockdown	214	Catheter	98	Tech Stools	341	Concealment	84-85
Cribs	230-232	Polymer	272-275	Therapy	170-173	Catheter Bag	97	Stainless Steel	212	HTM71	200-201	Twenty Four Hour Task & Operators Chairs	302-303	Cylinder	88-90
Mattress	230-232	Procedure	272-277	Treatment	154-173	Cylinder	91, 266	Mobile Pump Stands	208-209	Urinal Drainage	99	Visitor & Waiting Room Seating	332-333	Dispensing	112-114
Baby Cribs		Starsys	274-275	Variable Height	154-173	Document	77	Mobile Storage Units	401	Racking		Voyage Beam	338-339	Distribution	129, 197, 198
Variable Height	230-231	Catheter		Couch Steps	163	Glove Box	95	Mobile Workstations	400	HTM71	200-201	Waiting Room Seating	334-339	Dressing	102-106
Fixed Height	232	Bag Holders	97	Curtain Screens	80	Mask	94	Modular Seating	330-331	Polymer	360-363	Zeta Modular Seating	330-331	General Purpose	186-189
Bag & Sackholders		Racks	98	Cylinder		Sackholders	290-297	O		Top Track High Density Storage	366	Security Clamp	128	Hamper	223
Free Standing	295	Storage Units	402-403	Holder	91, 266	Sharps Box	97	Office, Task & Operator Chairs	300-304	Zinc Chrome	364-365	Self-Administration Cabinets	146-149	Instrument	102-106
Hamper	223	Chairs		Trolleys	88-90	Tab	246	Operating Platforms	394	Reclining Armchairs	310-321	Medical Records	352-355	Laminate Shelves	189
Removable Body	290-294	Bariatric	15-16, 304-305	Wall Brackets	91	Urine Bottle	91	Overbed & Chair Tables		Reclining Bariatric Armchairs	320-321	Sharps Box Holder	97	Medical Records	236-251
Plastic	296-297	Office, Task & Operators	300-304	Wall Plate	91	Wall Mounted Infusion	215	Economy	30	Reclining Porters Armchair	322-323	Shelving		Metal Dispensing	114
Soiled Linen	218-223	Low Back Patient Chairs	308	D		I		Laminate	32-33	Refrigerators	151	HTM71	200-201	Metal Distribution	129
Bariatric		Mata Chairs	332	Document Holders	77	Infusion		Polymer	31	Residents Own Medication Cabinets	146-149	Polymer	360-363	Metal Pharmacy	116-125
Commode	11, 14	Medical Grade Clean Room	348	Dispensers		Clamps	109, 215	Overnight Chair	238-329	Rest		Top Track High Density Storage	366	Mobile Workstation	271
Couches	164-169	Tech Chairs		Poles	94	Stands	208-214	P		Arm	162	Zinc Chrome	364-365	Open Transfer / Transport Trolleys	199
Folding Wheelchair	8-9	Medium & High Back	309	Glove	95	Infusion Stands		Paper Tabs	246	Leg	162	Soft Seating	330-331, 334-335	Pharmacy, Blister Pack (MDS)	120-121
Four Leg Chairs	16, 305	Patient Armchairs		Syringe	96	Easy Clean	208-211	Patient Armchairs	309	Resuscitation Carts	284-286	Soiled Linen Bags	223	Pharmacy, Biodeose & Multimed	124
High Back Chair	15, 304	Overnight Chair	328	Dispensing Trolleys		Knockdown	214	Patient Chairs	308	Resuscitation Trolleys	280-283, 287	Soiled Linen Trolleys	218-222	Pharmacy, Drawers	118
Phlebotomy Chair	178, 257	Phlebotomy	178-180, 256-259	High Capacity	113	Mild Steel	213	Patients Own Medication Cabinets	146-149	Rise & Recline Porters Armchair	324-325	Room Dividers	81	Pharmacy, Medinnox	125
Portering Chairs	10, 265	Portering	10, 262-267	Security Clamp	128	Stainless Steel	212	Perch Stools	307	Room Dividers	78-79	S		Pharmacy, Nomad	122-123
Rollator	17	Prima Chairs	333	Standard Capacity	112, 114	Trolley Clamping	109, 215	Personal Effects Lockers	384-385	Sackholders	290-297	Saddle Stools	306-307	Pharmacy, Patient Administration	116-117
Seating	16, 304-305	Prima Beam	336-337	Distribution Trolleys	129	Wall Mounted	215	Pharmacy Trolleys		20/50 Litre	290-291	ScanCell Carts	192-197	Pharmacy, Trays	388-391
Shower Chair	11-14	PU Saddle & Perch	307	Dressing Trolleys		Instrument Trolleys		Biodose® & MultiMeds	124	75/90 Litre	292-293	Screens	150	Phlebotomy	254-255
Training Suit	17	PU Tech Chairs	342	Drawers	107	Drawers	107	Blister Pack (MDS)	120-121	Free Standing	295	Curtain	80	Plaster	270
Treatment Chairs	174-175	PU Tech Stools	343	Fixed Shelves	104-106, 392-393	Drawers	107	Drawers	118	Fixed Body Plastic	296-297	Solid	81	Polymer Shelves	188
Walking Frame	17	Reclining Armchairs	310-321	Options	108-109	Fixed Shelves	104-106, 392-393	Laptop Holders	126	Saddle Stools	306-307	Cabinets	380	Resuscitation	280-283, 287
Beam Seating	336-339	Reclining Bariatric Armchairs	320-321	Removable Shelves	102-103	Options	108-109	Leg Rest	162	Static Safe Tech Stools	345	Catheter	402-403	Sepsis	352-355
Bedpan Drainage Rack	99	Reclining Porters Armchairs	322-323	Drug & Medicine		Removable Shelves	102-103	K		Static Safe & Sterile Tech Stools	347	Cupboards	378-379	Soiled Linen	218-222
Bedside Cabinets		Rise & Recline Porters Armchairs	323-324	Blister Pack Cabinets (MDS)	136	K		Key Cabinets	382-383	Static Safe & Sterile Tech Stools	347	Deep Shelf Cabinets	134-135	Stainless Steel Shelves	186-187
Melamine	22-29	Saddle Stools	306	Controlled Drug Cabinets	137-139	Key Cabinets	382-383	Kickabout Bowl Stand	391	Static Safe & Sterile Tech Stools	347	Shelves & Door Shelf Cabinets	132-133	Sterile Supplies	372-375
Polymer	20-21	Soft Seating	330-331, 334-335	Cupboards	142-145	Kickabout Bowl Stand	391	Kickabout Bucket Stand	391	Static Safe Tech Chairs	344	Refrigerators	151	Suture Storage	395
Bins		Static Safe Tech Chairs	344	Deep Shelf Cabinets	134-135	L		L		Static Safe Tech Stools	345	Drug & Medicine Cabinets	132-136	Wooden Dispensing	112-113
Freestanding	295	Static Safe Tech Stools	345	Shelves & Door Shelf Cabinets	132-133	Laminata Overbed & Chair Tables	32-33	Pharmacy & Vaccine Refrigerators	151	Static Safe & Sterile Tech Stools	346	Drug & Medicine Cupboards	142-145	U	
Removable Body	290-294	Static Safe & Sterile Tech Chairs	346	Refrigerators	151	Laptop Holders	126, 244	Phlebotomy Trolleys	254-255	Static Safe & Sterile Tech Stools	347	Drug & Medicine Cupboards	142-145	Urinal Drainage Rack	99
Plastic	296-297	Static Safe & Sterile Tech Stools	347	Drug & Medicine Cabinets	132-136	Leg Rest	162	Phlebotomy Chair		Plastic	296-297	Office, Task & Operators	300-304	Urine Bottle Holder	97
Body Tray	85	Tech Chairs	340	Drug & Medicine Cupboards	142-145	E		Fixed Height	180, 258-259	Body Tray	85	Low Back Patient Chairs	308	V	
Bowl Stands	388-391	Tech Stools	341	E		Economy Overbed Table	30	Variable Height	178-179, 256-257	Bucket Stands	391	Mata Chairs	332	Variable Height Examination	154-183
C		Twenty Four Hour Task & Operators Chairs	302-303	Economy Overbed Table	30	Examination Chairs	223	Plaster Trolleys	270	Cabinets		Medical Grade Clean Room	348	Couches & Chairs	332-333
Cabinets		Visitor & Waiting Room Seating	332-333	Examination Chairs	174-177	Examination Couches	154-173	Plastic Bins	296-297	Bedside	22-29	Medium & High Back	309	Visitor & Waiting Room Seating	332-333
Bedside, Melamine	22-29	Voyage Beam	338-339	Examination Couches	154-173	F		Cribs	230-232	Bedside, Polymer	20-21	Patient Armchairs	309	W	
Bedside, Polymer	20-21	Waiting Room Seating	334-339	F		Filing Pockets	246	Procedure Carts	272-277	Clinical Reagent	381	Overnight Chair	328	Waiting Room Seating	334-339
Clinical Reagent	381	Zeta Modular Seating	330-331	Fixed Height Examination Couches	161	Fixed Height Examination Couches	161	Pocket Mask Holder	94	Controlled Drug Cabinets	137-139	Phlebotomy	178-180, 256-259	Wall Mounted Infusion Holders	215
Controlled Drug	137-139	Chart Boards	76	Fixed Height Phlebotomy Chairs	180, 258-259	Locker		Polymer Bedside Cabinets	20-21	Cupboards	142-145	Mayo	394	Waste Bins	290-297
Drug & Medicine	132-136	Chart Trolleys	72-73	First Aid Cabinets	381	Personal Effects	384-385	Polymer Overbed & Chair Tables	31	Deep Shelf Cabinets	134-135	Prima Chairs	333	Wooden Dispensing Trolleys	112-113
First Aid	381	Chart Workstations		Free Standing Sackholders	295	Storage	384-385	Polymer Shelving & Racking	360-363	Shelves & Door Shelf Cabinets	132-133	Prima Beam	336-337	X	
Key	382-383	Fixed Height	74	G		Mask Holder	94	Polymer General Purpose Trolleys	188	Refrigerators	151	PU Saddle & Perch	307	X-Ray Filing Cabinet	251
Patients Own	146-149	Variable Height	75	General Purpose Trolleys	186-189	Mayo Tables	394	Portering Chairs	262-267	Static Safe Tech Stools	344	PU Tech Chairs	342	Z	
Residents Own	146-149	Clamping Infusion Stand Trolley	109, 215	Glove Box Holders	95	Medical Records		Portering Chairs		Static Safe Tech Stools	345	PU Tech Stools	343	Zinc Chrome Shelving & Racking	364-365
Self Administration	146-149	Clean Linen Trolleys	222, 224-227	Glove Box Dispenser	95	Carefile Filing Pockets	246	Portering Chairs		Static Safe & Sterile Tech Stools	346	Therapy Couch	170-173		
Storage	380	Concealment Trolleys		H		Laptop Holders	244	Portering Chairs		Static Safe & Sterile Tech Stools	347	Transfer & Transport Trolleys	199		
X-Ray Filing	251	Body Tray	85	Hamper Bag Trolleys	223	Motion C5 Holder	245	Bariatric	10, 265	Static Safe & Sterile Tech Stools	347	Treatment			
						Trolleys	236-241	Front Steer	263-264	Static Safe & Sterile Tech Stools	347	Chair	174-177		
						Workstations	242-243	Options	266-267	Static Safe Tech Chairs	344				
								Rear Steer	262	Static Safe Tech Stools	345				

Paint & Laminate

Paint

Painted surfaces should be cleaned using a soft damp cloth and polished completely dry. Do not use abrasive cloth. Persistent exposure to wet or humid conditions could result in rust marks or cause the paint to lift. Concentrated bleach, synthetic detergents, solvents, wax polishes or aerosol sprays should not be used.

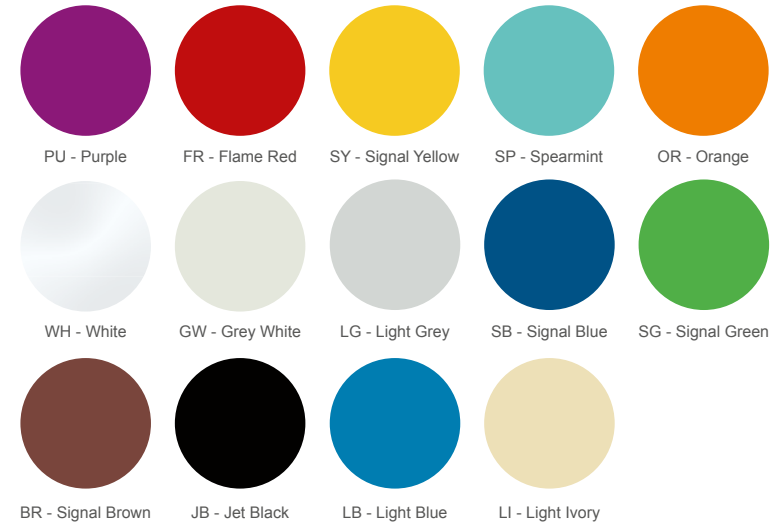

Laminate & Melamine

Laminates and melamine should be cleaned using a soft damp cloth and polished completely dry. Do not use abrasive cloth. Concentrated bleach, synthetic detergents, solvents, wax polishes or aerosol sprays should not be used.

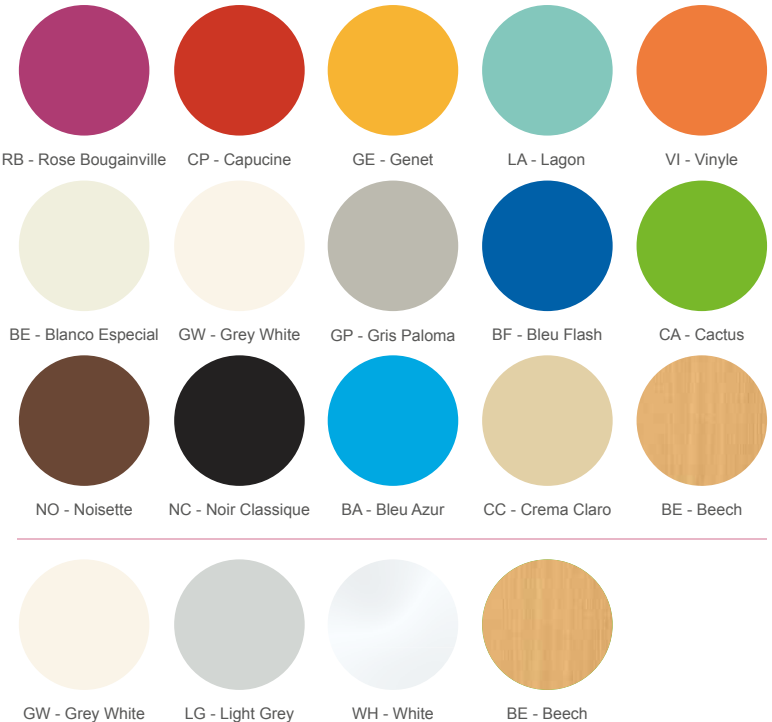

Vinyl

Ambla New Richmond in Colour - Spradling Valencia C5 - Memphis Faux Leather

Vinyl's are resistant to most mild acids, alkalis, drinks & household stains. Clean with a damp, soapy cloth and rinse well with clean water. Dry the surface thoroughly. A soft brush with soapy water may be used to remove stubborn stains. Ensure surfaces are then rinsed and dried. Do not use solvents, bleaches*, abrasives, synthetic detergents, wax polishes or aerosol sprays. Disinfectants may be used in dilution as specified by their manufacturers.

*Chlorine Releasing Agents: Levels of 1-10,000 parts per million should pose no problems as long as the material does not endure long soakings at the higher concentrations. Rinse well with clean water. These include Haz-Tab's & other disinfectants commonly used in hospital infection control programmes. Surfaces are NaDCC compatible.

Ambla New Richmond in Colour

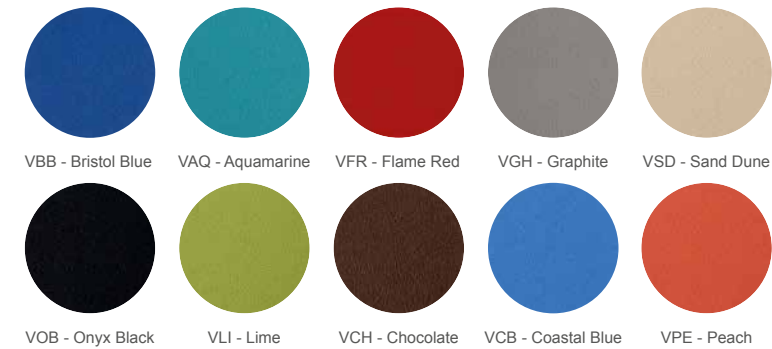

Spradling Valencia C5

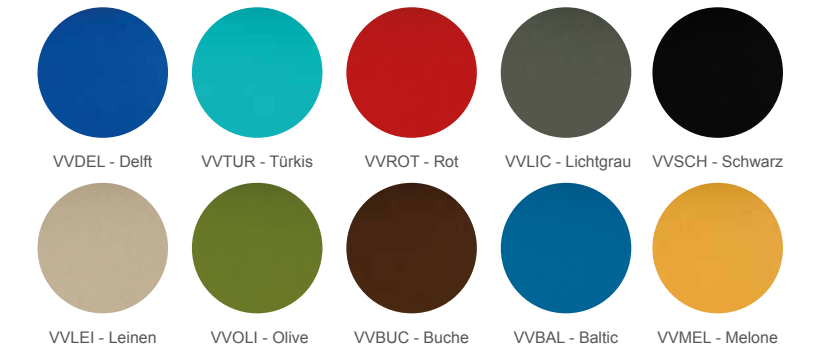

Memphis Faux Leather

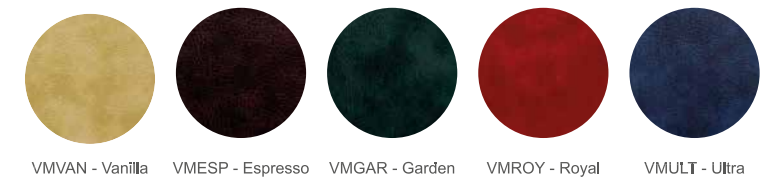

Fabric & Plastic

Camira Advantage

Vacuum regularly. Wipe clean with a damp cloth or shampoo using proprietary upholstery shampoo.

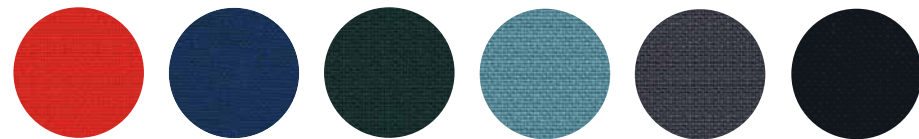

FRD - Red FCT - Cobalt FAC - Aztec FKR - Kingfisher FGE - Granite FBK - Black

Camira 24/7 Flax

Vacuum regularly. Professionally dry clean or wipe clean with a damp cloth.

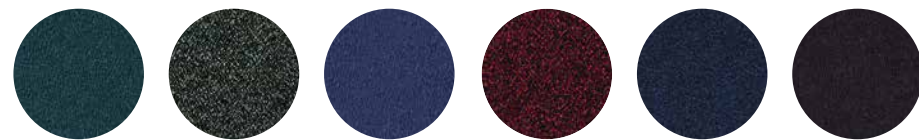

FYR09 - Zone FYR06 - Indiction FYR02 - Vernal FYR15 - Annual FYR03 - Equinox FYR21 - White

VP Multi-Way Stretch

Wipe with mild detergent. Wash or dry clean using detergent up to 75°C. For disinfection use sodium hypochlorite at no more than 1,000 parts per million of active chlorine. Do not use biological or phenolic-based cleaners. Wash and dry completely before storage. Some surface wrinkling may occur.

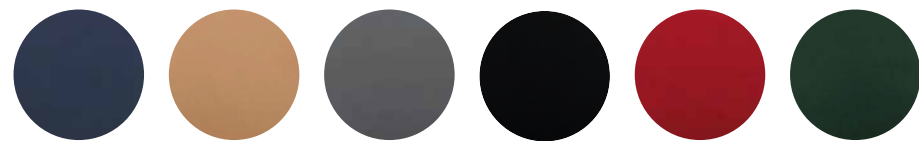

VPNB - Navy Blue VPBE - Beige VPGY - Grey VPBL - Black VPRE - Red VPGR - Green

Panaz Patternistas For Children

Vacuum regularly. Wipe clean with a damp cloth. Can be cleaned with water based proprietary cleaners and 5% sodium chlorite bleach solution, Haz-Tabs or Chlor-Clean.



SAVL - Savanna Lavender

Plastic Seat Shells

Plastic should be cleaned using a soft damp cloth and polished completely dry. Do not use abrasive cloth. Concentrated bleach, synthetic detergents, solvents, wax polishes or aerosol sprays should not be used.

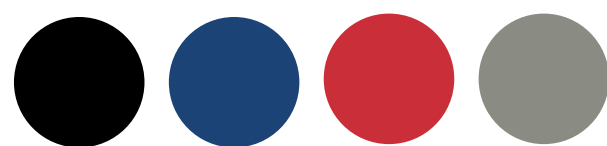

SBK - Black SBE - Blue SRD - Red SGY - Grey



SWH - White SOE - Olive SMO - Mango

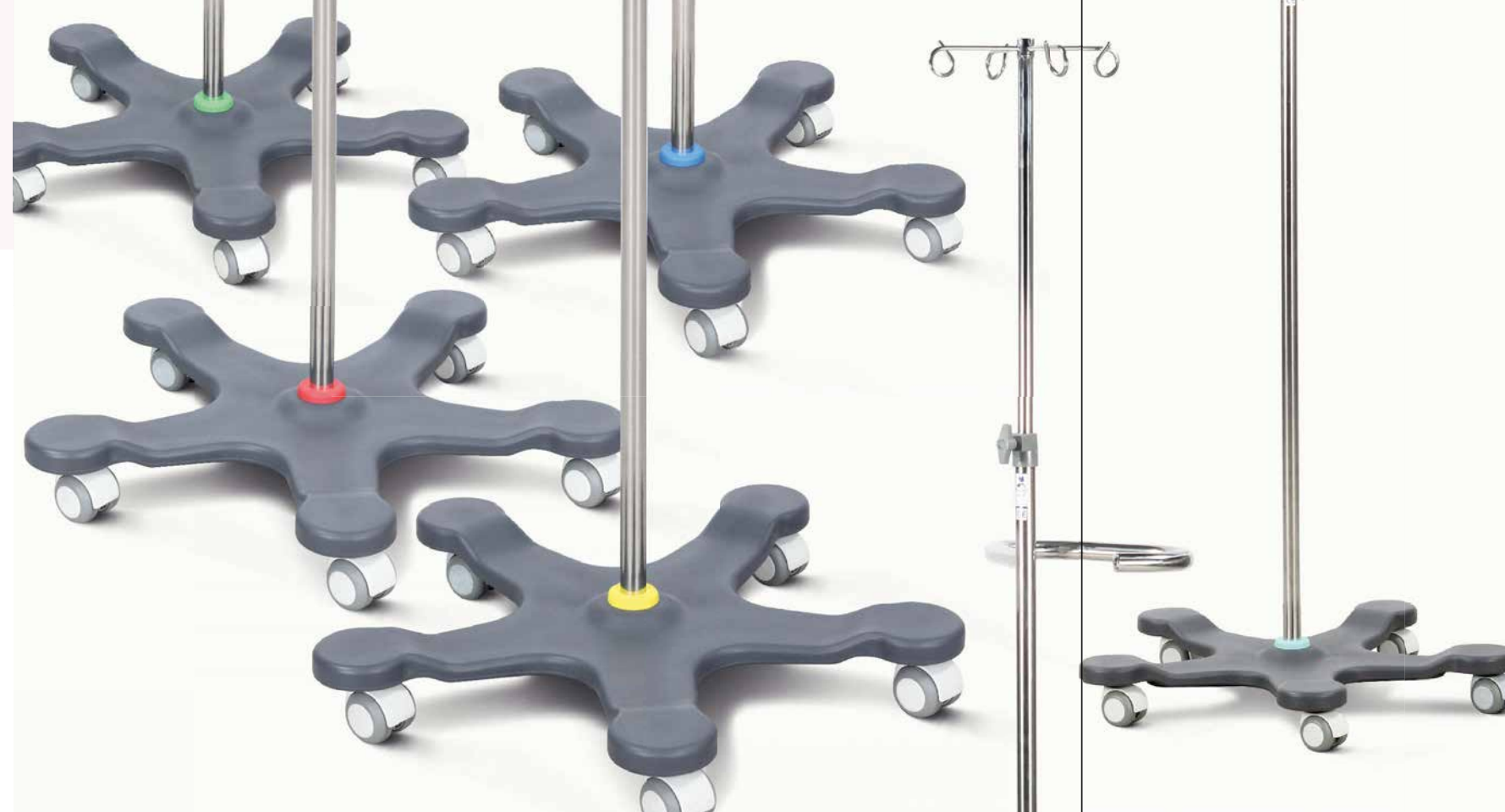

Mobile Infusion Stands
Polyurethane, Easy Clean

See Page 210

Technical Information

Dimensions & Weight

- Dimensions are stated in millimetres (width x depth x height)
- Weights are stated in kilograms
- Please ensure you are aware of the item size & weight prior to ordering

Castors

- All castors are fitted with non-marking tyres (with exception of some anti-static versions)
- Anti-static castors can be identified by either a yellow mark on the edge of the tyre, or where twin wheel castors are used a different colouration to the tyre (the result of the addition of a conductive material)
- Castors & wheel bearings do not require specific maintenance other than regular cleaning
- The use of oil will breakdown the grease applied to the bearings, reducing the life of the castor
- We recommend that fittings are checked regularly & re-tightened as required
- Where anti-static castors are fitted, we recommend that the tyre is periodically cleaned to remove any dirt to ensure a good contact between the tyre & the floor

Locks & Keys

- Locks should operate smoothly. If they do not please arrange urgent attention & where necessary, obtain a replacement
- Locks require only minimal maintenance and should only be lubricated using a dry lubricant such as graphite which can be purchased from most locksmiths (NEVER USE OIL)
- When ordering replacement locks or keys, please ensure that the product code & any letters/numbers from the key & lock are available

Stainless Steel

- We use 304 & 430 grade stainless steel
- Grade 304 is non-magnetic & used on products which are not painted
- Grade 430 is magnetic & will be subsequently painted
- Please note that the term 'stainless' is not entirely accurate, as certain chemicals can 'eat' into the surface. In particular, 'iodine' which can badly corrode/stain & as a result should not be used as a cleaning agent. Stainless steel products should always be dried after cleaning to reduce staining

Paint

- We only use lead free epoxy polyester powder paint
- Where possible colours are applied in special booths to allow for overspray to be recycled
- Alternative colours are available at additional cost

Wood, Melamine & Laminate

- We only use FSC accredited materials. This provides assurances that the material is produced from well-managed forests &/or recycled materials
- We use a combination of melamine faced MDF / chipboard & high pressure laminates bonded MDF of chipboard substrates
- Edges are protected with 2mm ABS, T-Barb edging or sealed with varnish
- Both melamine & laminate panels offer some resistance to water penetration under normal usage
- We only use water based adhesives & varnishes

Upholstered Panels & Fabrics

- Vinyl upholstered panels are manufactured from 'Flame Retardant' materials, independently tested to BS 5852: 2006 Ignition Source 5, BS EN 1021-1: 2006, BS EN 1021-2: 2006 & BS 7176: 2007 Medium Hazard. Standard vinyl colours also contain an anti-microbial compound within its construction, which constantly migrates to the surface to replenish any material which is removed by cleaning or general usage
- Fabric upholstered panels are manufactured from 'Flame Retardant' materials, independently tested to BS 5852: 2006 Ignition Source 5, BS EN 1021-1:2006, BS EN 1021-2:2006 & BS 7176: 2007 Low Hazard
- Ward screens are manufactured from 'Flame Retardant' materials, independently tested to BS 5438: Part 2

Technical Information

Electric Columns & Actuators

- Electric columns & actuators comply with EMC Directive 2014/30/EU, Low Voltage Directive 2014/35/EU & RoHS2 Directive 2011/65/EU

Preventative Maintenance, Spares & Service Support

Bristol Maid™ products are designed & manufactured to cater for the demands of the healthcare environment, with the majority (under normal conditions) providing many years of trouble free service. Where annual maintenance or periodic inspections are required, we can offer comprehensive planned preventative maintenance through either a scheduled service contract or call out by our own trained Engineers. For your peace of mind & continued product reliability, please contact our customer service team for details on the following services.

- Preventative maintenance contracts & packages
- Supply of spare parts
- Site audit & equipment recommendations

Cleaning Guidance & Instructions

The maintenance of high standards of cleanliness on all surfaces and equipment is a crucial factor in the prevention and control of infection. Whilst all dust, dirt and moisture can harbour infection, the key risks are associated with contamination arising from contact with blood, body fluids, mucous membranes and damaged skin. In all cases surfaces, must be thoroughly cleaned and disinfected in order to destroy any pathogenic micro-organisms.

Bristol Maid products have been designed for use in demanding environments. Guidance & instructions can be found at - www.bristolmaid.com/cleaning

Medical Devices

Where applicable, Hospital Metalcraft product is marked with the CE symbol to demonstrate compliance with the essential requirements of any European Directives (& transposing regulations) that may apply & for which a Declaration of Conformity is held. Hospital Metalcraft is registered with the MHRA (Medicines & Healthcare Regulatory Authority) in connection with product classified as 'Class 1 Medical Devices' for purposes of the Medical Devices Directive (93/42/EEC) with the registration number CA001358.

WEEE Regulations

Hospital Metalcraft meets its obligations as a business to business producer of Electrical and Electronic Equipment (EEE) through:

- Membership of the Veolia Environmental Services WEEE, (Waste Electrical & Electronic Equipment), Producer Compliance Scheme (Registration No. WEE/KE0677RX)
- Marking EEE placed on the market by Hospital Metalcraft with the mandatory crossed out wheeled bin symbol & Bristol Maid™ logo
- Making information available, (for EEE placed on the market after April 2007), to assist those engaged in treatment, recovery & recycling activities
- Arranging for the collection, treatment, recovery & environmentally sound disposal of obligated WEEE



Meet The Team

Here at Bristol Maid™ our dedicated sales and customer service team are committed to finding a solution that works for you. Whether you require a full ward refurbishment or just simply some advice on our products, we are here to help. Refer to the map on the right for your regional sales representative or alternatively contact our friendly customer services team....

Sales Director



Ian Farnfield
01258 451338
ifarnfield@bristolmaid.com

Technical Services Manager



Paul Open
popen@bristolmaid.com

Sales Support



Ian Mills
Sales Support Engineer (South)
07921 473241
imills@bristolmaid.com



Eric Hornby
Sales Support Engineer (North)
07702 000953
ehornby@bristolmaid.com

Customer Services



Sammy Foord
Customer Service Team Leader
sfoord@bristolmaid.com



Mark Champion
Assistant Customer Service Team Leader
mchampion@bristolmaid.com



Sophie Williams
Customer Service Coordinator
swilliams@bristolmaid.com



Jessica Haines
Customer Service Coordinator
jhaines@bristolmaid.com



Kirsty Geoghegan
Customer Service Team Leader
kgeoghegan@bristolmaid.com



Sam Symes
Customer Service Coordinator
ssymes@bristolmaid.com



Stacey Finch
Customer Service Coordinator
sfinch@bristolmaid.com

National Sales Manager



Steve Poller
07711 095899
spoller@bristolmaid.com

External Sales Representatives



Grant Macpherson
Scotland, N.Ireland
& Northumberland
07768 057675
gmacpherson@bristolmaid.com



Chris Davis
London
07725 543862
cdavis@bristolmaid.com



John Baines
South & South West
07876 441477
jbaines@bristolmaid.com



Duncan Holder
North
07790 916052
dholder@bristolmaid.com



Russell Sheard
Midlands
07887 534755
rsheard@bristolmaid.com



Nick Moyster
South East
07500 039301
nmoyster@bristolmaid.com

Export



Simon Haines
Export Manager
Tel: +44 (0)7917 207617
DDI: +44 (0)1258 484430
Email: shaines@bristolmaid.com



David Morton-Jones
Export Coordinator
+44 (0)1258 484468
dmortonjones@bristolmaid.com

Bristol Maid's policy is to work together with selected partners who are able to support and advise in the selection of appropriate 'Healthcare Solutions', also providing a high level of customer care and portraying our traditional values. Our continued success and growth within international markets has created a demand for additional partners.

We are seeking to encourage applications from interested parties. If you, or your organisation have the qualities we are seeking please contact us.



Manufacturing Medical Furniture & Equipment Since 1953

With over 65 years of experience, Bristol Maid is a leading manufacturer and supplier of medical furniture & equipment. From design and manufacture to supply and installation, Bristol Maid has a reputation for providing high product quality, excellent customer service and value for money.

We take pride in working in close partnership with our customers applying innovative design and technology to deliver effective solutions for today while anticipating the needs of tomorrow.

Hospital Metalcraft Limited
Blandford Heights, Blandford Forum,
Dorset. DT11 7TG, UK
Tel: +44 (0) 1258 451338
Fax: +44 (0) 1258 455056
sales@bristolmaid.com
www.bristolmaid.com



**MADE IN
BRITAIN** 

Bristol Maid™ 
Hospital Metalcraft™ Limited

