



# S MURRAY & CO

Holborn House Old Woking  
Surrey GU22 9LB England

Telephone +44 (0)1483 740099

Fax +44 (0)1483 755111

e-mail [sales@smurray.co.uk](mailto:sales@smurray.co.uk)

[www.smurray.co.uk](http://www.smurray.co.uk)

## SURGICAL INSTRUMENTS

© 2001 S Murray & Co Ltd  
Registered in England No 145824  
Authorised Share Capital £1,000,000

Surgical Instruments: Catalogue

This catalogue is copyright and no  
part of it may be reproduced without  
our express written consent.

Designed and produced by  
Knowles Thompson PLC  
Printed in England

---



## COMPANY PROFILE

S Murray & Co was established in 1915, initially as a manufacturer and distributor of medical glassware, later diversifying into a wider range of scientific and healthcare consumables.

In 1948 the company acquired George Gill & Sons (Surgical) Ltd, since when production of high quality Sheffield made instruments has been continuous, expanding to the comprehensive range illustrated in this catalogue. This expansion has continued through the acquisition of Nowlin & Son in 1990 and Heeley Surgical in 1999.

Benefits of manufacture in Sheffield include immediate access to raw materials, technical expertise and skilled personnel, for which the region is internationally recognised as a centre of excellence.

Sales administration, warehousing and distribution are based at the Company's Woking Headquarters where experienced staff welcome trade and export enquiries.

Best possible service is assured by substantial stock holding of finished instruments at Woking, and part manufactured components at Sheffield.

S Murray & Co plays an active role in the representation and development of British manufacturing on a national and international level through its membership of the Surgical Instruments Section of the Association of British Health-Care Industries (ABHI).

## THIS CATALOGUE

Instruments are listed alphabetically according to surgical procedure (see contents page v). They are also listed both by name and instrument type in the comprehensive cross-referenced index starting on page 237.

Line drawings have been used throughout to provide best possible clarity.

There is an indication of the relative sizes of instruments shown on each page, but drawings are not to exact scale. Inset drawings of instrument tips are intended to show detail, only T/C needleholder tips are actual size.

Instructions for reprocessing reusable surgical instruments are given on page IV.

## GUARANTEE

The quality of all S Murray instruments is guaranteed to be free of defects in workmanship and materials. In the unlikely event that any item is found to be unsatisfactory in normal use it will be refurbished or replaced free of charge. This guarantee is firm for at least 10 years, except for replacement of T/C tips on needleholders and re-sharpening of hard edge scissors, which will be free of charge for 3 years.

## QUALITY

S Murray & Co was one of the first healthcare manufacturers to obtain BS 5750 part 2 certification in 1991. All Company personnel are committed to improve and enhance quality procedures at all levels of production, purchase and supply.

The Company's registration was upgraded to BS EN ISO 9002:1994 in May 1995, assuring customers of continued professional service, and properly controlled quality of product.

S Murray will continue to maintain its approval to the latest revisions of all relevant quality standards, with copies of our current certificates of approval available upon request.

Instruments of a special nature, which are not within the Company's manufacturing programme, originate only from manufacturers whose quality assurance procedures are thoroughly known to S Murray & Co.

The Company is also committed to the development of all employees through the principles of the Investors in People Standard.

Products in this catalogue (except for diathermy instruments and tracheostomy tubes, which are subject to notified



body approval) are Class I Devices according to rule 6, annex IX of the Council Directive concerning Medical Devices (93/42/EEC) and they comply with all relevant essential requirements of that Directive.

Patterns defining the form of these instruments and procedures defining method of manufacture are maintained as part of the Company's quality system, with full traceability throughout every stage of the manufacturing process.



## S MURRAY INSTRUMENTS

Suitable for theatre, ward, veterinary, dental and chiropody use; manufactured from high grade stainless steel, all instruments comply with the specifications set by ISO 7153-1.

Standard instruments are finished to a bright mirror polish; specialised instruments include Tungsten Carbide Needleholders – satin finished with gold plated bows; also Diathermy Forceps with distinctive blue insulation.



## S MURRAY SCISSORS

Manufactured by specialists, working to the same quality criteria as the company's instrument makers.

All S Murray scissors have bright mirror polish finish; Hard Edge Scissors have stellite blades and gold plated bows; Ultracut Scissors have serrated top blades to prevent tissue slippage and razor edged bottom blades to allow precise effortless cutting.



## S MURRAY SERVICE

Comprehensive catalogues are available in book and CD ROM formats to support both U.K. and overseas distributors.

Large stocks held in Woking and part finished components at Sheffield allow best possible delivery times. Visitors are welcome at the Sheffield factory to experience the company's commitment to quality throughout the manufacturing process.





# INSTRUCTIONS FOR RE-PROCESSING REUSABLE DEVICES

The following instructions are for all reusable medical devices shown in this catalogue, unless stated otherwise with the packaging of the product. These instructions are intended for use only by persons with the required specialist knowledge and training.

## WARNINGS

- Follow instructions and warnings as issued by manufacturers of any decontaminants, disinfectants and cleaning agents used. Wherever possible avoid use of mineral acids and harsh, abrasive agents.
- No part of the process shall exceed 140°C.
- Aluminium based products are damaged by high alkaline solutions (pH >10).
- Devices with long, narrow cannula, hinges and blind holes require particular attention during cleaning.

## Limitations on Reprocessing

- Repeated processing has minimal effect on these instruments.
- End of life is normally determined by wear and damage in use.
- Any specific limitations on the number of reprocessing cycles shall be made available with the instrument.

## INSTRUCTIONS

### From Point of Use

- If possible, soiled instruments should be placed in a holding solution (combined disinfectant / enzyme solution) immediately after use and prior to cleaning, avoiding the use of bleach-based solutions.

**Note:** *this process is not suitable for aluminium instruments.*

### Preparation for Decontamination

- Disassemble where intended by trained staff only, without the use of tools unless specifically provided by the manufacturer.
- Reprocess all instruments as soon as it is reasonably practical following use.

### Cleaning: Automated

- **Use only either CE marked or validated washer-disinfector machines and cleaning agents, following the manufacturers' instructions for use, warnings and recommended cycles.\***
- Load instruments carefully, with any box joints and hinges open and so that any fenestrations in instruments can drain.
- Place heavy instruments with care in the bottom of containers.
- Place instruments with concave surfaces (e.g. currettes) facing down to prevent pooling of water.

### Cleaning: Manual

- **Manual cleaning is not advised if an automatic washer-disinfector is available. If this equipment is not available, use the following process:** -

**One:** Using a sink dedicated for instrument cleaning (not used for hand washing), rinse excess soil from instrument (water temp <35°C).

**Two:** Keeping the instrument submerged in the water, with a brush, apply CE marked cleaning solution to all surfaces. Pay particular attention to serrations, teeth, ratchets and hinges, always brushing away from the body. Ensure rongeurs and hinged instruments are thoroughly cleaned in both open and closed positions.

**Three:** Rinse instruments thoroughly with clean water, so that the water reaches all parts of the instrument, then carefully hand dry or use an industrial drying cabinet.

**Note:** *when manual cleaning is used it may not be possible to disinfect the device prior to further handling.*

### Cleaning: Inspection

- After cleaning, check all surfaces, cannulations, holes and lumens for complete removal of soil.
- If any soil is still visible, return the instrument for repeat decontamination.

**Note:** *automated cleaning may not be suitable for all lumens and cannulae, in which case clean manually with an appropriate brush (and stilette if provided) that reaches the depth of the feature.*

### Maintenance

- Apply surgical grade lubrication oil to hinges, joints and moving parts as per the lubrication oil manufacturer's instructions.

### Inspection and Function Testing

- Visually inspect and check:-
  - all instruments for damage and wear
  - cutting edges are free of nicks and present a continuous edge
  - jaws and teeth align correctly
  - all articulated instruments have a smooth movement without excess play
  - locking mechanisms (such as ratchets) fasten securely and close easily
  - long, slender instruments are not distorted
  - any component parts fit and assemble correctly with mating components.
- Remove for repair or replacement any blunt, worn out, flaking, fractured or damaged instruments.

**Note:** *if an instrument is returned to the manufacturer / supplier, the instrument must be decontaminated and sterilised and be accompanied with the relevant documented evidence.*

### Packaging

- All instruments to be packed following local protocol in accordance to BS standards.

### Sterilisation

- **Either CE marked or validated vacuum autoclave operating at 134-137°C 2.25 bar for a minimum holding time of 3 minutes - always following the instructions of the machine manufacturer.**
- When sterilising multiple instruments in one autoclave cycle, ensure that the steriliser manufacturer's stated maximum load is not exceeded.
- Ensure instruments are dry before sterilisation. If the instruments cannot be dried prior to sterilisation, then use distilled/de-ionised water in the final-rinse stage of cleaning.

### Storage

- Ensure instruments are dry before storage, and stored in dry, clean conditions at an ambient room temperature and away from direct sunlight.

### Additional Information

- Other forms of **cleaning** (ultrasonic, alkaline and neutral) and **sterilisation** (Low Temperature Steam, Formaldehyde, Ethyleneoxide and Gas Plasma) are available. However, always follow the instructions for use as issued by the manufacturer and always consult with them if in any doubt over the suitability of any process used.

\* **Follow cleaning and sterilisation guidelines as per HTM 2010 and HTM 2030.**

It is the responsibility of the reprocessor to ensure that the reprocessing as actually performed using equipment, materials and personnel in the reprocessing facility achieve the desired result. This requires validation and routine monitoring of the process. Likewise any deviation by the reprocessor from the instructions provided must be properly evaluated for effectiveness and potential adverse consequences.



<b>GENERAL SURGERY</b>	<b>vi</b>	<b>GEN</b>
<b>THORACIC SURGERY</b>	<b>62</b>	<b>THO</b>
<b>GYNAECOLOGY &amp; OBSTETRICS</b>	<b>70</b>	<b>GYN</b>
<b>UROLOGY</b>	<b>86</b>	<b>URO</b>
<b>PROCTOLOGY</b>	<b>90</b>	<b>PRO</b>
<b>DENTAL INSTRUMENTS</b>	<b>98</b>	<b>DENT</b>
<b>CHIROPODY INSTRUMENTS</b>	<b>134</b>	<b>CHIR</b>
<b>NEUROSURGERY</b>	<b>138</b>	<b>NEU</b>
<b>ORTHOPAEDIC SURGERY</b>	<b>156</b>	<b>ORTH</b>
<b>EAR, NOSE &amp; THROAT</b>	<b>178</b>	<b>ENT</b>
<b>PLASTIC SURGERY</b>	<b>218</b>	<b>PLA</b>



GEN

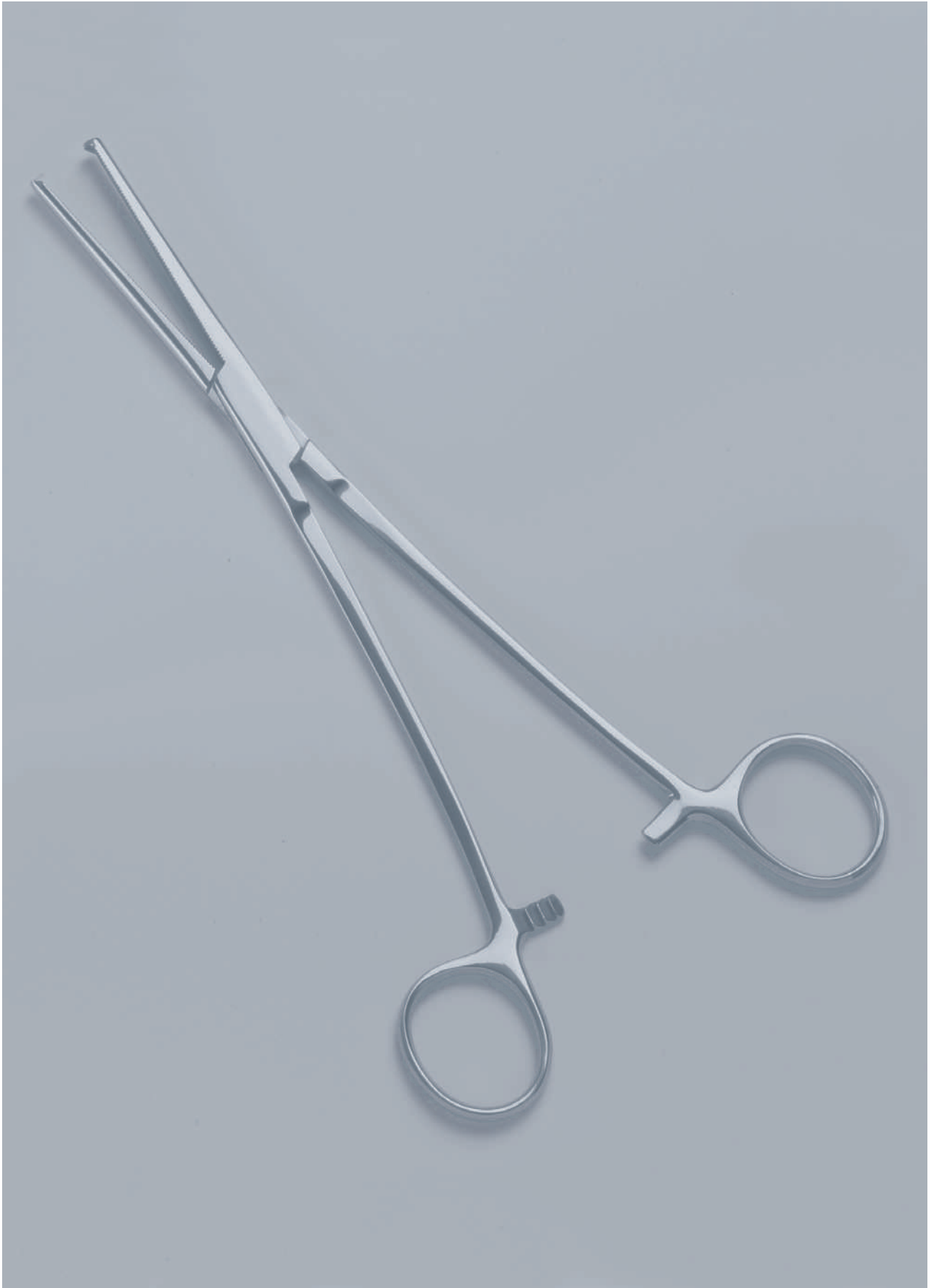

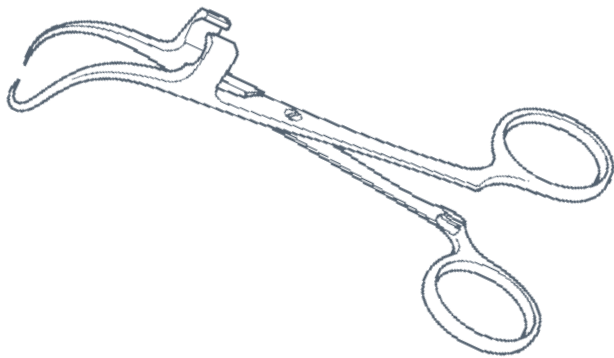

ANCHORING FORCEPS

Robin

screw joint

**1005/05** 5mm diameter holder for diathermy leads, 140mm

**1005/10** 13mm diameter holder for suction tubing, 140mm

**1005/15** 25mm diameter holder for anaesthetic tubing, 140mm

ARTERY FORCEPS

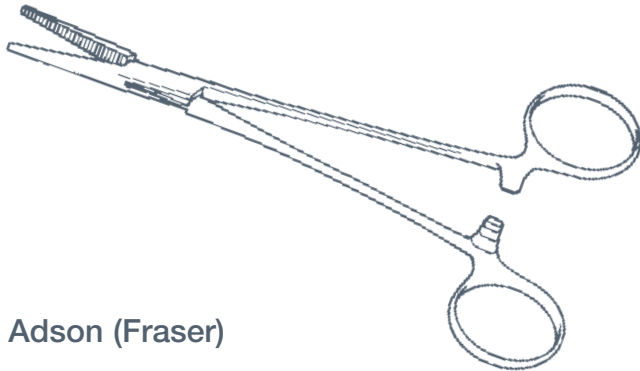

Adson (Fraser)

straight

**1017/05** 180mm

curved

**1018/05** 180mm

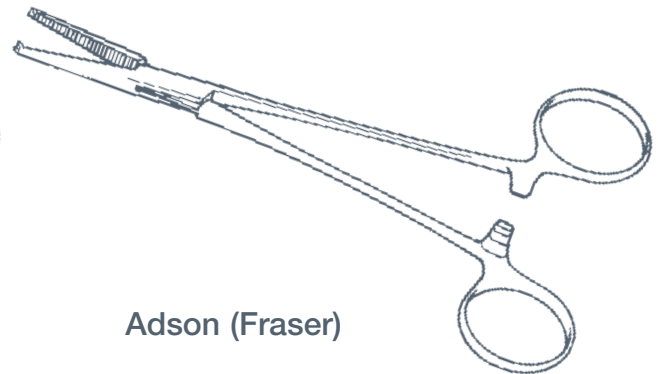

Adson (Fraser)

straight, 1/2 teeth

**1019/05** 180mm

curved, 1/2 teeth

**1020/05** 180mm

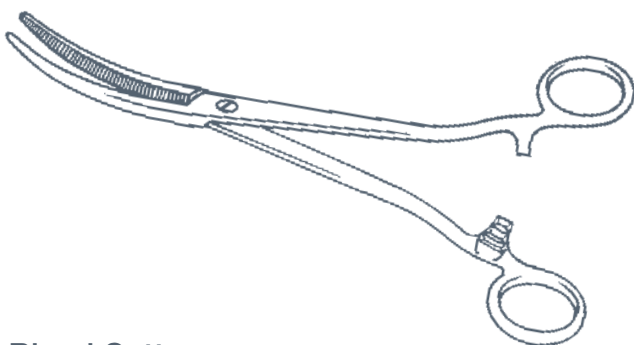

Bland Sutton

curved, screw joint

**1026/05** 180mm

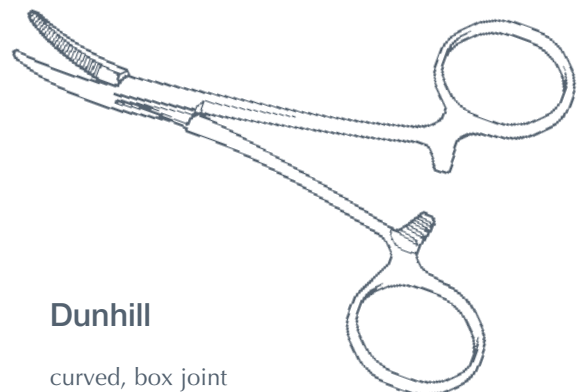

Dunhill

curved, box joint

**1034/05** 125mm

**1034/10** 180mm

straight, box joint

**1035/05** 125mm





# ARTERY FORCEPS

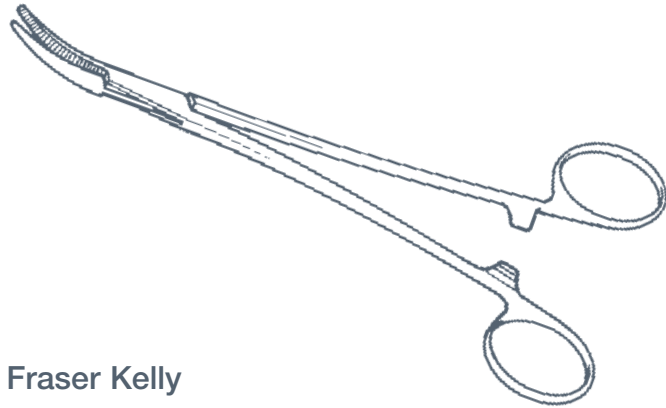

**Fraser Kelly**

curved  
1038/05 180mm



**Grey Turner**

straight  
1040/05 145mm  
1040/10 180mm



curved  
1041/05 145mm  
1041/10 180mm

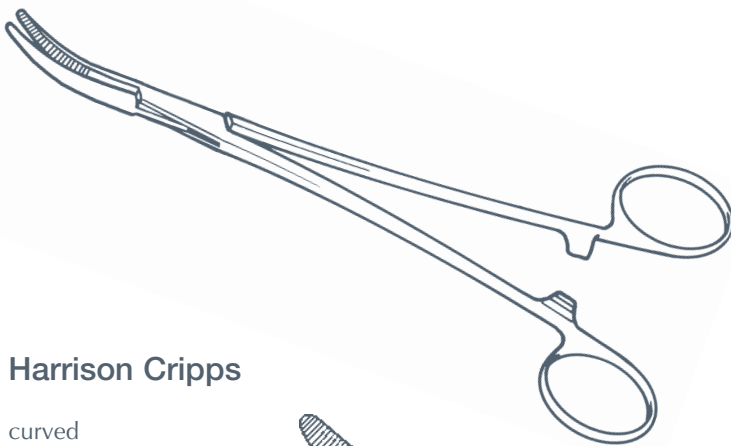
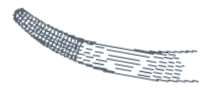

**Harrison Cripps**

curved  
1042/05 175mm

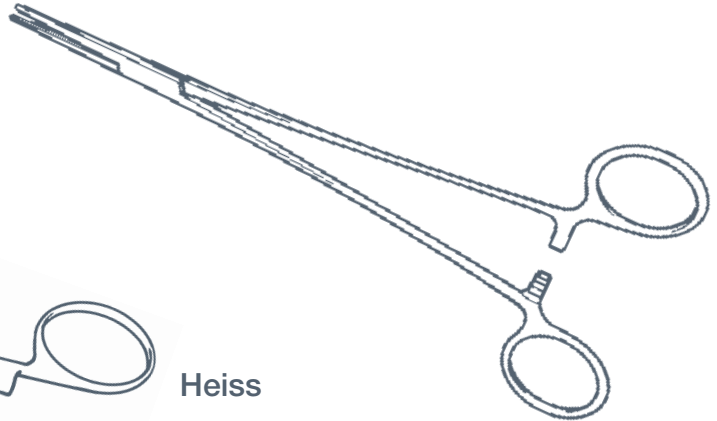

**Heiss**

straight  
1043/05 200mm



slightly curved  
1043/10 200mm



curved  
1043/15 200mm

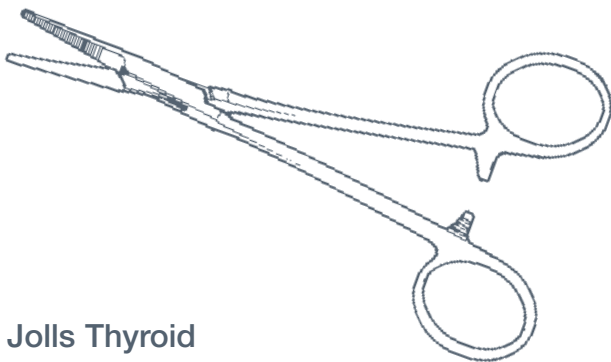

**Jolls Thyroid**

straight  
1044/25 150mm

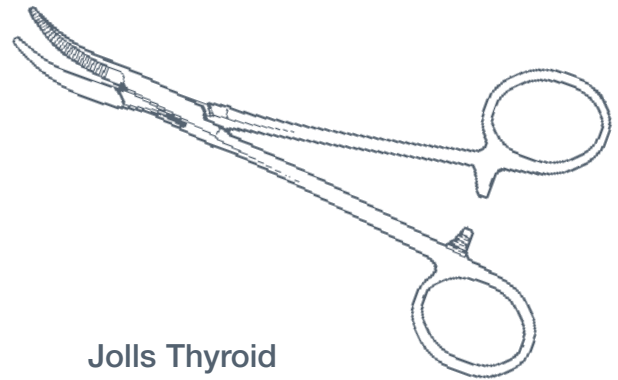

**Jolls Thyroid**

curved  
1044/50 150mm







ARTERY FORCEPS

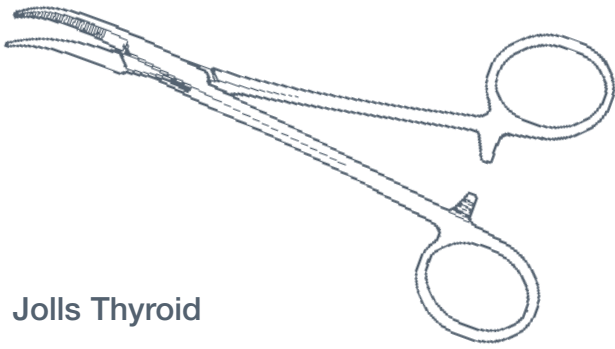

**Jolls Thyroid**

curved to side  
1044/75 150mm

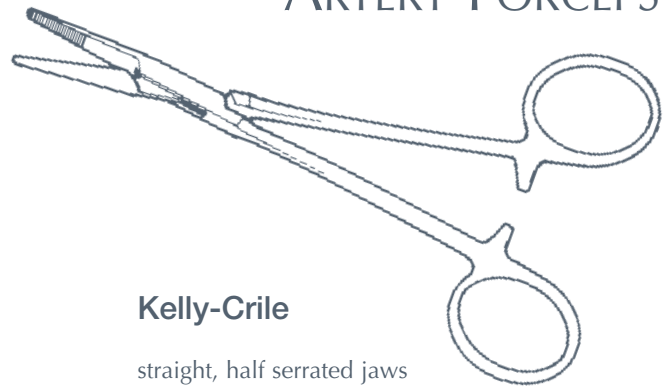

**Kelly-Crile**

straight, half serrated jaws  
1046/05 145mm  
1046/10 160mm



curved, half serrated jaws  
1047/05 145mm  
1047/10 160mm

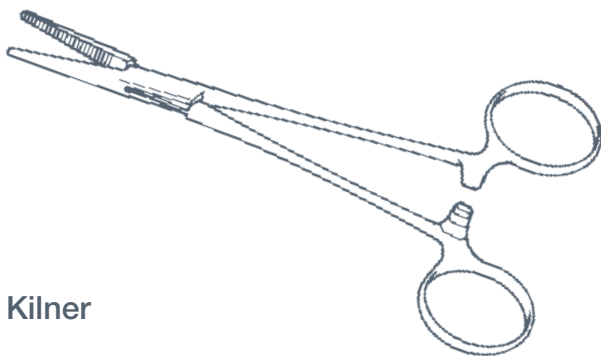

**Kilner**

straight, serrated jaws  
1050/05 140mm



curved, serrated jaws  
1051/05 140mm

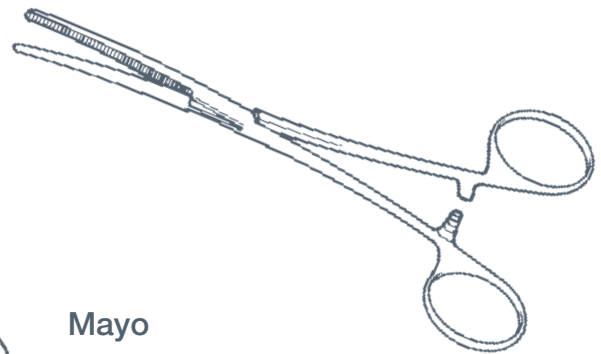

**Mayo**

curved  
1060/05 150mm

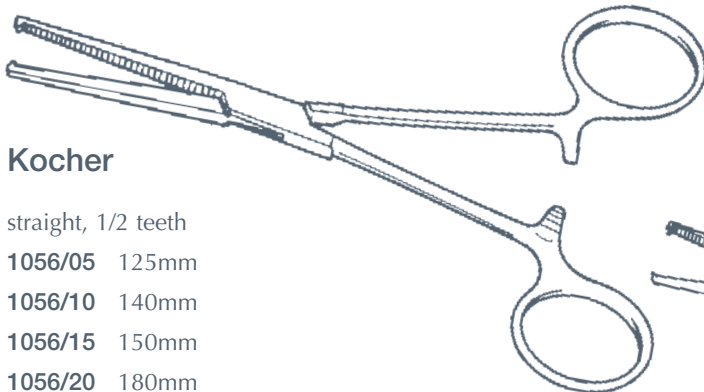

**Kocher**

straight, 1/2 teeth  
1056/05 125mm  
1056/10 140mm  
1056/15 150mm  
1056/20 180mm  
1056/25 200mm  
1056/30 230mm



curved, 1/2 teeth  
1057/05 125mm  
1057/10 140mm  
1057/15 150mm  
1057/20 180mm  
1057/25 200mm  
1057/30 230mm

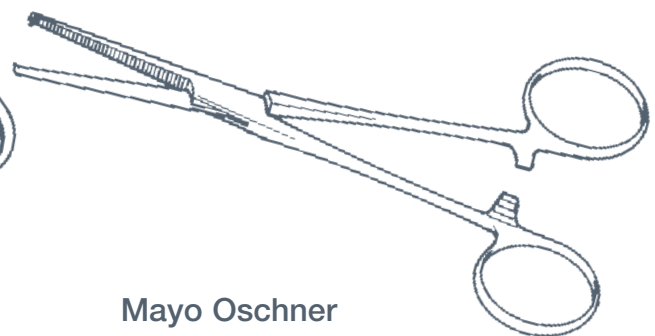

**Mayo Oschner**

straight  
1063/05 185mm



curved  
1064/05 185mm





# ARTERY FORCEPS

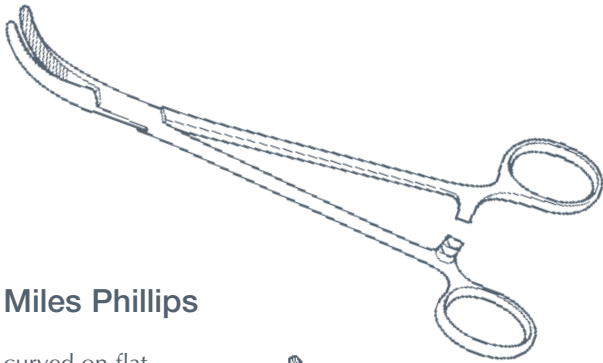

**Miles Phillips**

curved on flat  
1067/05 180mm

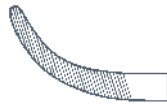

**Mixer Baby**

curved, half serrated jaws  
1069/05 140mm  
1069/10 180mm

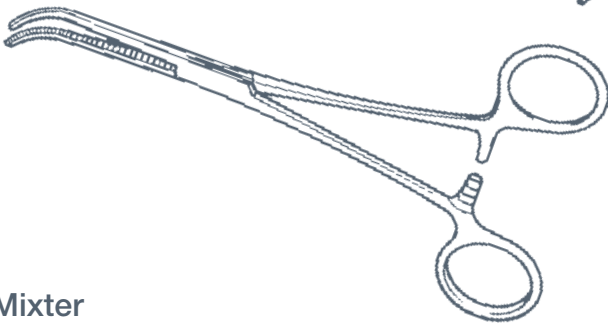
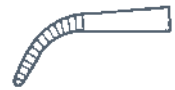

**Mixer**

curved, serrated jaws  
1070/05 150mm  
1070/10 180mm

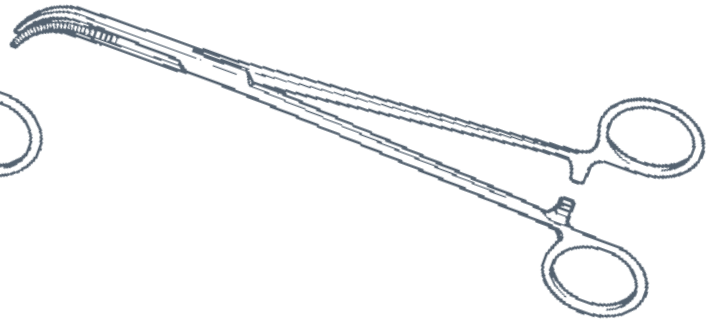

**Mixer**

curved, half serrated jaws  
1070/15 220mm

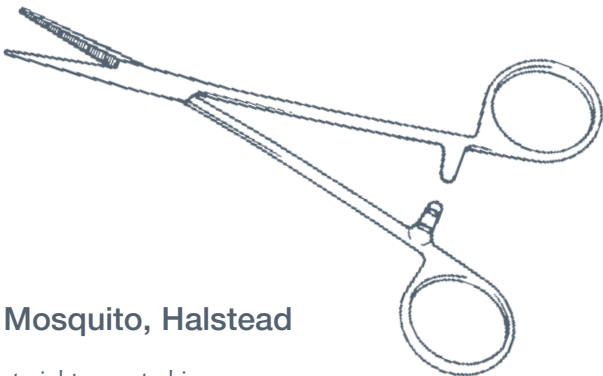

**Mosquito, Halstead**

straight, serrated jaws  
1073/10 95mm  
1073/15 125mm



curved, serrated jaws  
1074/10 95mm  
1074/15 125mm

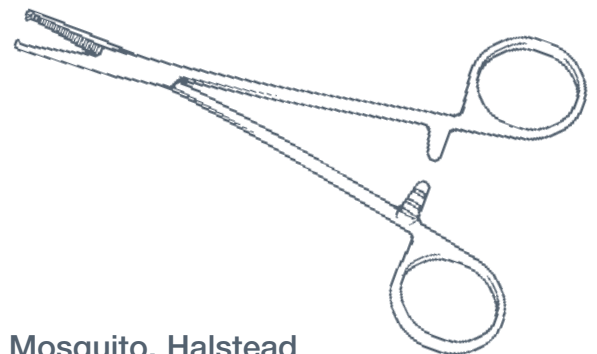

**Mosquito, Halstead**

straight, 1/2 teeth  
1075/05 125mm



curved, 1/2 teeth  
1076/05 125mm





ARTERY FORCEPS

GEN

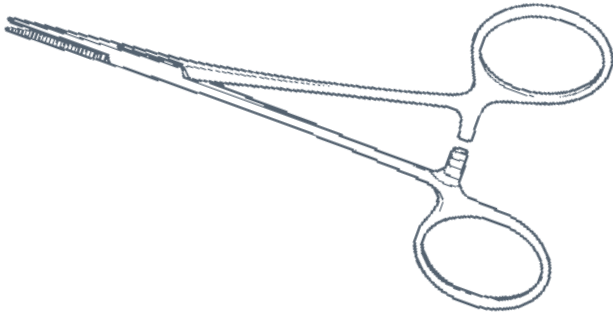

**Mosquito, Micro**

straight

1078/05 120mm



curved

1079/05 120mm

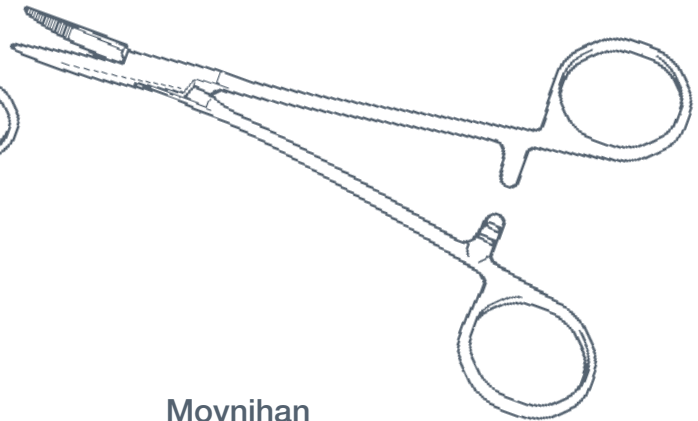

**Moynihan**

straight, half serrated jaws

1082/05 145mm

1082/10 180mm



curved, half serrated jaws

1083/05 145mm

1083/10 180mm

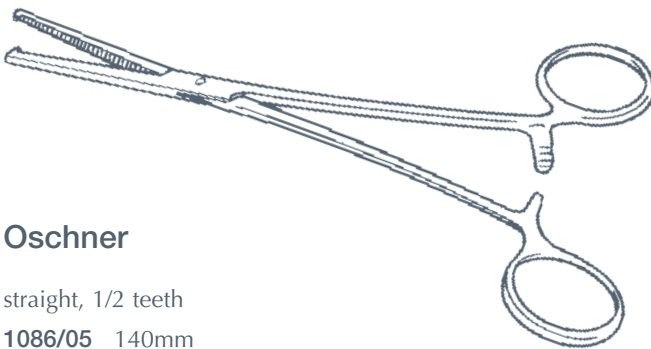

**Oschner**

straight, 1/2 teeth

1086/05 140mm

1086/10 165mm

1086/15 180mm

1086/20 200mm

1086/25 220mm

1086/30 240mm



curved, 1/2 teeth

1087/05 140mm

1087/10 165mm

1087/15 180mm

1087/20 200mm

1087/25 220mm

1087/30 240mm

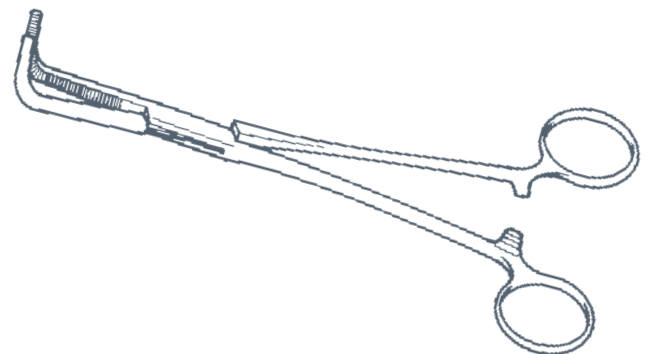

**O'Shaughnessy**

curved

1090/05 150mm

1090/10 180mm

1090/15 200mm

1090/20 230mm

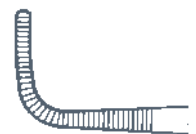



GEN

# ARTERY FORCEPS

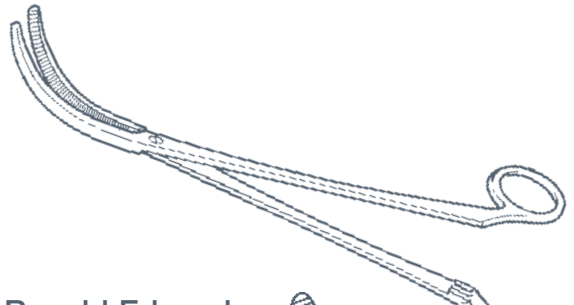

## Ronald Edwards

curved, screw joint  
1102/25 215mm shape A

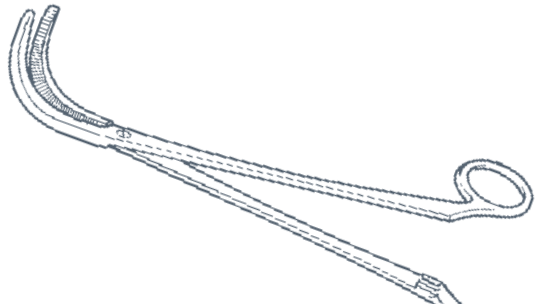

## Ronald Edwards

curved, screw joint  
1102/50 215mm shape B

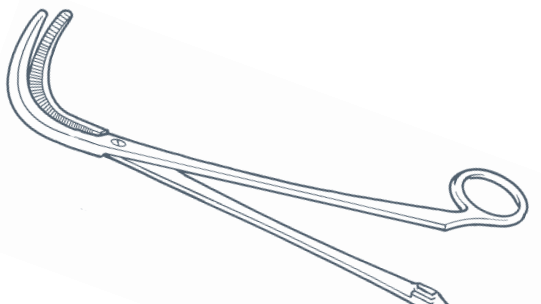
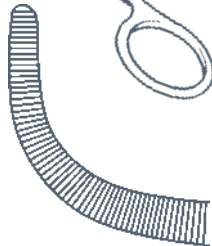

## Ronald Edwards

curved, screw joint  
1102/75 215mm shape C

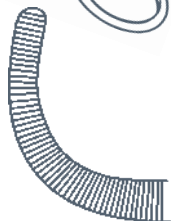

## Rochester-Pean

- straight
- 1097/05 140mm
- 1097/10 160mm
- 1097/15 180mm
- 1097/20 200mm
- 1097/25 220mm
- 1097/30 240mm
- 1097/35 260mm



- curved
- 1098/05 140mm
- 1098/10 160mm
- 1098/15 180mm
- 1098/20 200mm
- 1098/25 220mm
- 1098/30 240mm
- 1098/35 260mm

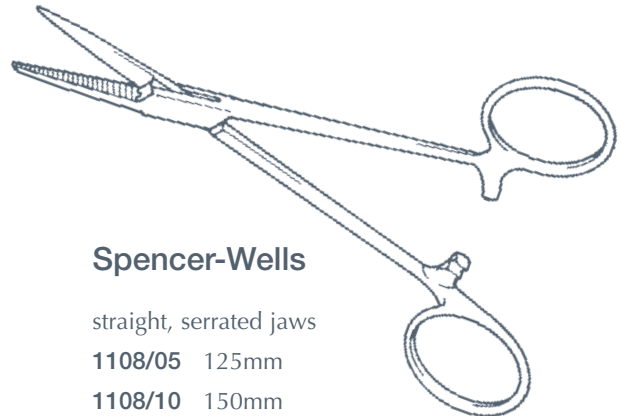
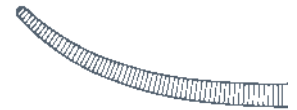

## Spencer-Wells

- straight, serrated jaws
- 1108/05 125mm
- 1108/10 150mm
- 1108/15 180mm
- 1108/20 200mm
- 1108/25 230mm



- curved, serrated jaws
- 1109/05 125mm
- 1109/10 150mm
- 1109/15 180mm
- 1109/20 200mm
- 1109/25 230mm



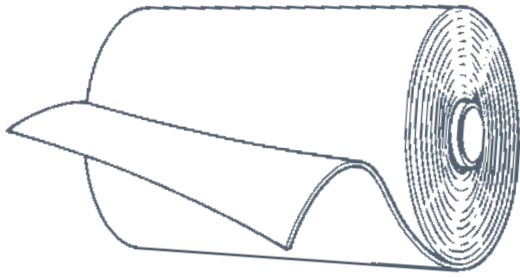

BANDAGE

**Esmarch**

rubber

1112/05 3.0metres x 76mm

1112/10 5.5metres x 76mm



BRUSH

**Wire**

for cleaning instruments

1120/05 280mm

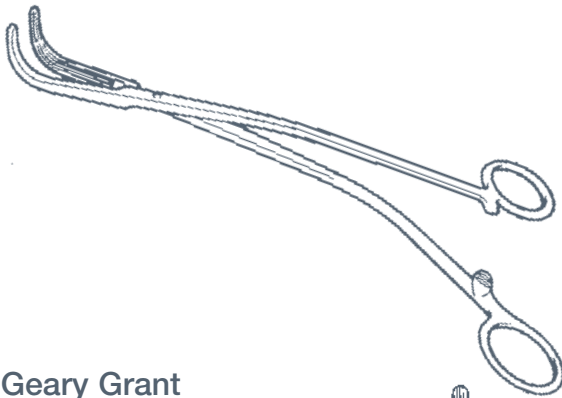

CHOLECYSTECTOMY FORCEPS

**Geary Grant**

small, non-toothed jaws, longitudinal serrations 230mm

1121/05

large, non-toothed jaws, longitudinal serrations 230mm

1121/10

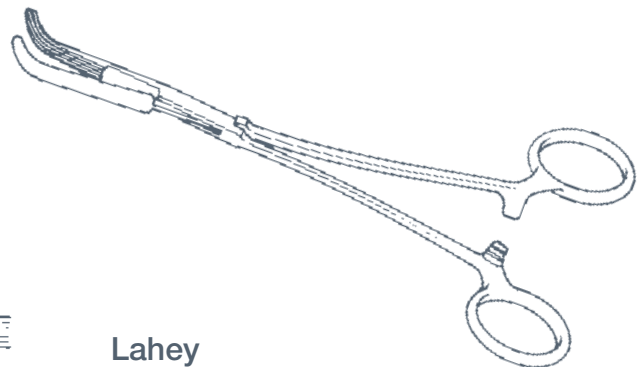

**Lahey**

curved, longitudinal serrations

1124/05 195mm

1124/10 230mm



**Moynihan**

curved on flat, box joint

1127/05 215mm

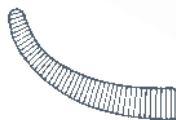
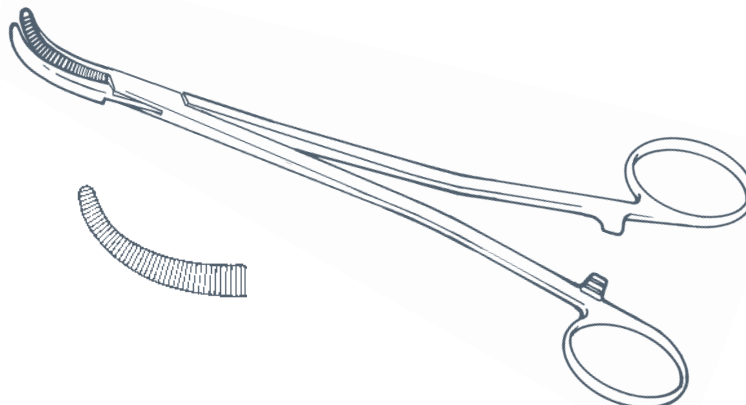



GEN

## CLAMPS

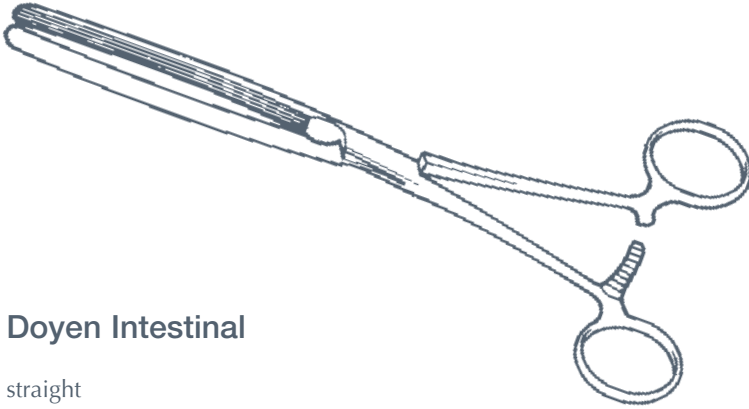

### Doyen Intestinal

straight

**1134/05** 180mm

**1134/10** 230mm



curved

**1135/05** 180mm

**1135/10** 230mm

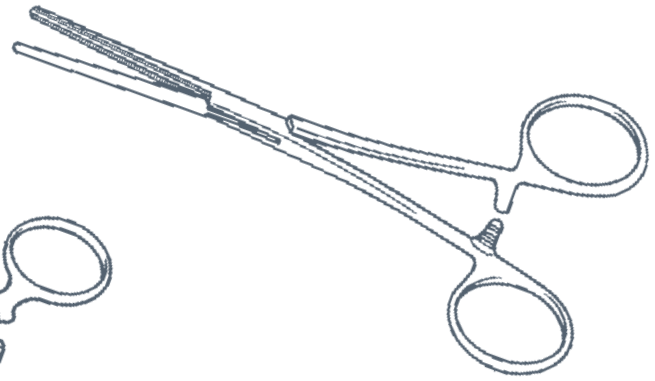
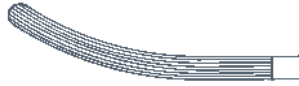

### Fergusson Angiotribe

straight

**1138/05** 165mm

**1138/10** 200mm



curved

**1139/05** 165mm

**1139/10** 200mm



### Kocher Intestinal

straight, longitudinal serrations,  
light spring blades

**1141/05** 225mm, 100mm blades

**1141/10** 250mm, 125mm blades

**1141/15** 275mm, 150mm blades



curved, longitudinal serrations,  
light spring blades

**1142/05** 225mm, 100mm blades

**1142/10** 250mm, 125mm blades

**1142/15** 275mm, 150mm blades

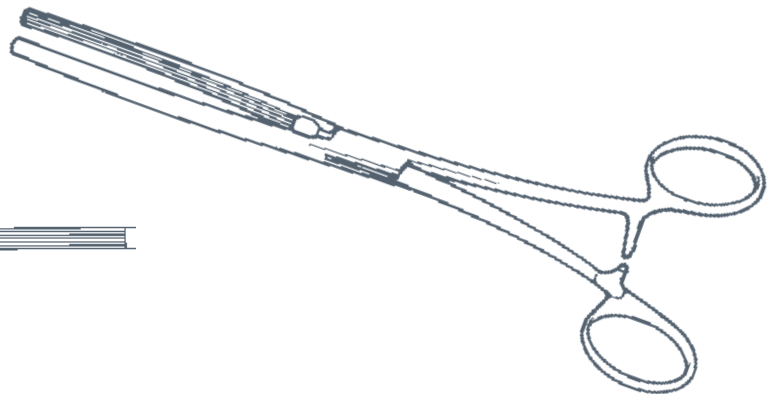

### Lanes Intestinal

straight, longitudinal serrations

**1145/05** 215mm, 75mm blades

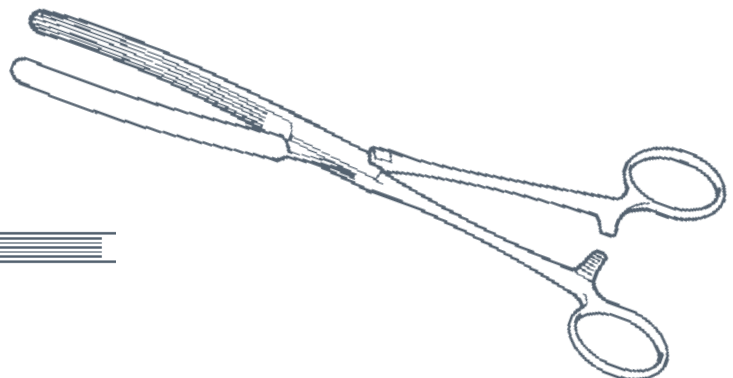



CLAMPS

GEN

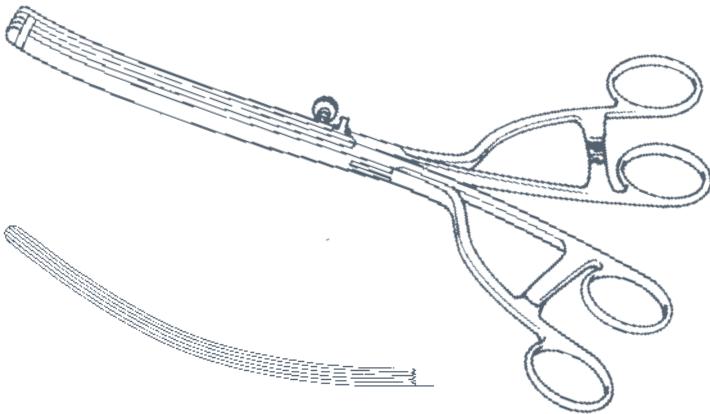

**Lanes Twin**

straight, longitudinal serrations

1148/05 305mm

curved, longitudinal serrations

1149/05 305mm

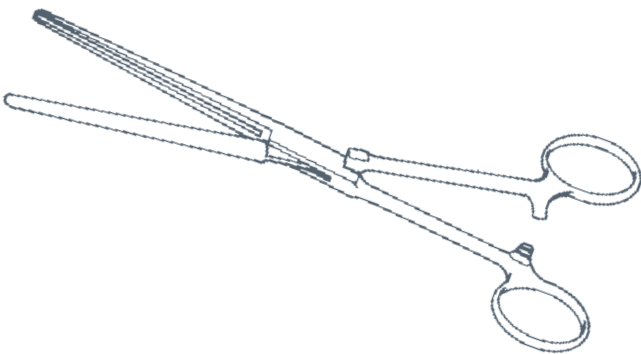

**Lang Stevenson**

keyed blades

1152/05 200mm, 80mm blades

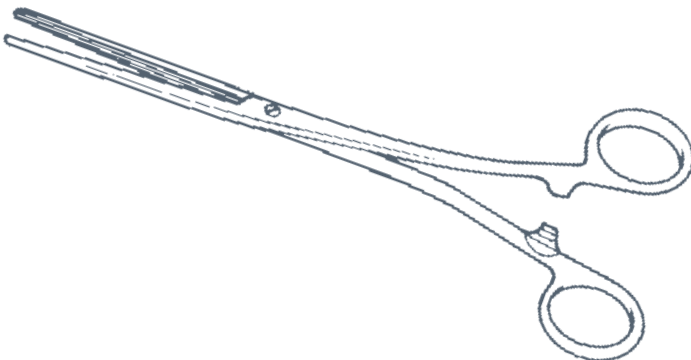

**Parker Kerr**

straight, screw joint

1155/05 230mm

1155/10 255mm

curved, screw joint

1156/05 230mm

1156/10 255mm





GEN

## CLAMPS

### Payr

crushing, lever action, longitudinal serrations

1159/05 150mm, 50mm blades

1159/10 210mm, 65mm blades

1159/15 255mm, 100mm blades

1159/20 350mm, 150mm blades

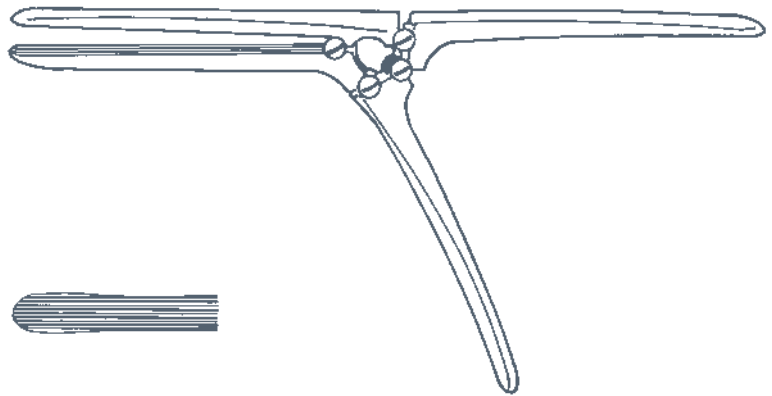

### Schoemaker-Ogilvie

straight for hemisphincterectomy,  
hollow blades

1162/05 170mm

1162/10 215mm

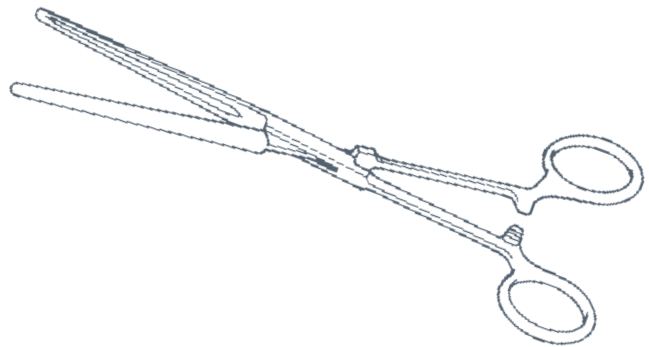

## CLAMPS, ATRAUMATIC

### Doyen

straight

1174/15 180mm

1174/25 230mm

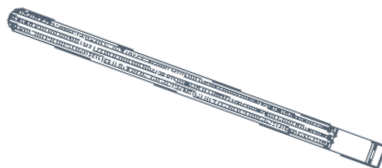

curved

1175/15 180mm

1175/25 230mm

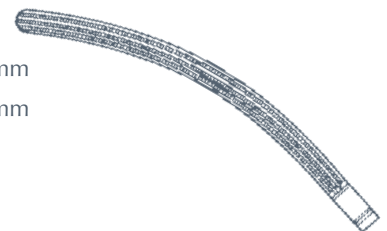





CLIP FORCEPS

GEN

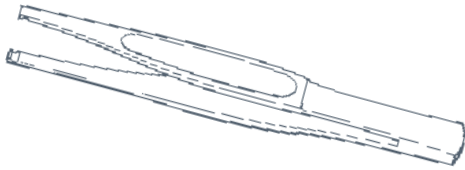

**Comyns Berkeley**

applying, serrated jaws 140mm  
1178/05

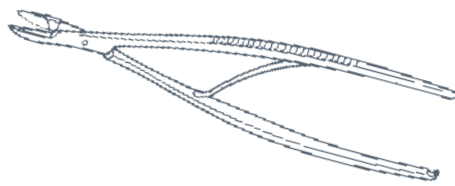

**Michel**

applying and extracting combined 125mm  
1183/05

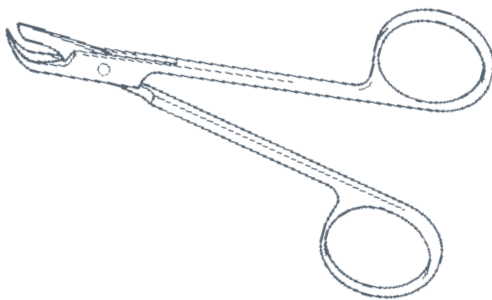

clip extracting 120mm  
1185/05

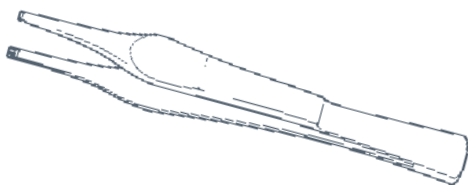

applying 125mm  
1188/05

DIATHERMY



**Cable**

red rubber covered  
1204/05 3 metres  
1204/10 5 metres



### DIATHERMY

#### Carrier

for ball and plate electrodes  
1207/05 straight



#### Electrode

ball, silver  
1213/05 5mm  
1213/10 8mm



#### Handle

for knife electrode and electrode carrier  
1215/05



#### Handle

for loops and needles  
1216/05

#### Loops

fine (30swg)  
1222/05 8mm  
1222/10 10mm  
1222/15 12mm  
1222/20 14mm



stout (25swg)  
1223/05 8mm  
1223/10 10mm  
1223/15 12mm



#### Quiver

plastic with ring 200mm x 65mm  
1231/05  
telescopic, extends to 400mm x 65mm  
1231/25



#### Carrier

for ball and plate electrodes  
1208/05 curved

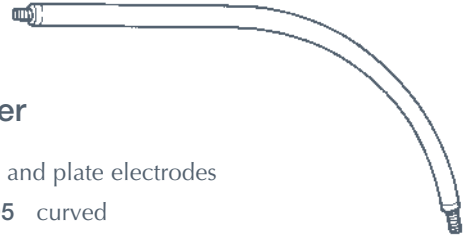

#### Electrode

plate, silver  
1213/55 8mm  
1213/60 10mm

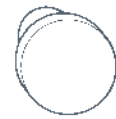

#### Knife Electrode

Monel metal blade 50mm  
1219/05



#### Needles

fine (25swg)  
1226/05 short 20mm  
1226/10 long 32mm  
1226/15 angled 30mm



medium (22swg)  
1227/05 short 20mm  
1227/10 long 32mm  
1227/15 angled 30mm



stout (19swg)  
1228/05 short 20mm  
1228/10 long 32mm  
1228/15 angled 30mm





DIATHERMY FORCEPS

GEN

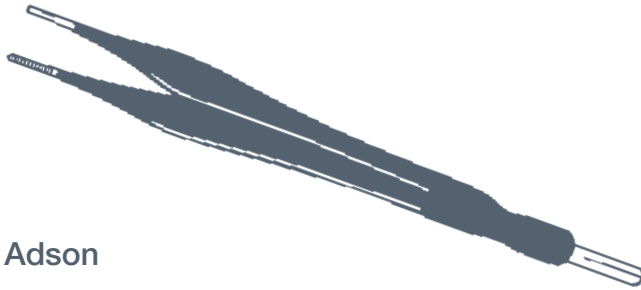

**Adson**

serrated

1237/05 125mm

1237/10 180mm



**Adson**

1/2 teeth

1238/05 125mm

1238/10 180mm



**Dissecting**

serrated

1244/05 100mm

1244/10 150mm

1244/15 180mm

1244/20 200mm

1244/25 240mm

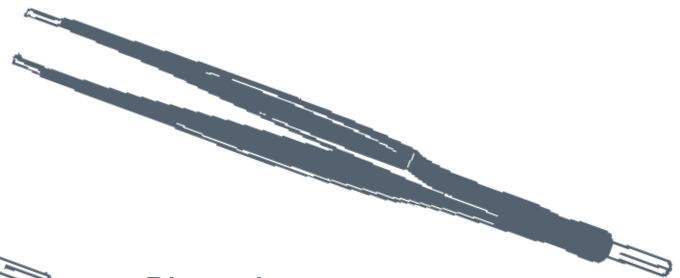

**Dissecting**

1/2 teeth

1247/05 100mm

1247/10 150mm

1247/15 180mm

1247/20 200mm

1247/25 240mm

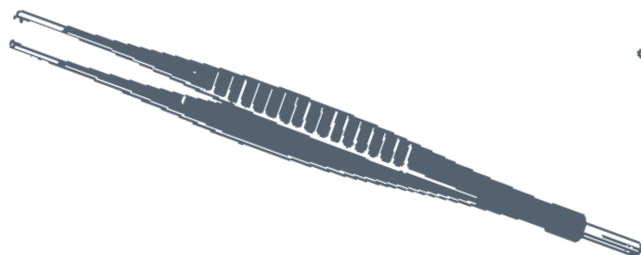

**Gillies**

1/2 teeth

1250/05 150mm

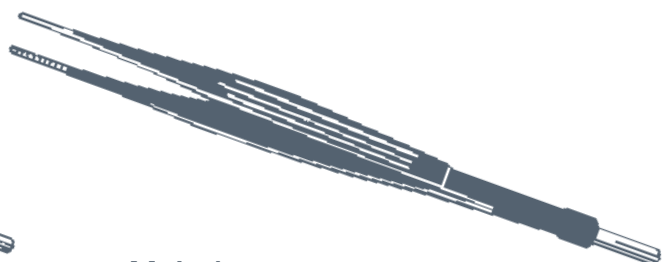

**McIndoe**

serrated

1253/05 150mm





# DIATHERMY FORCEPS

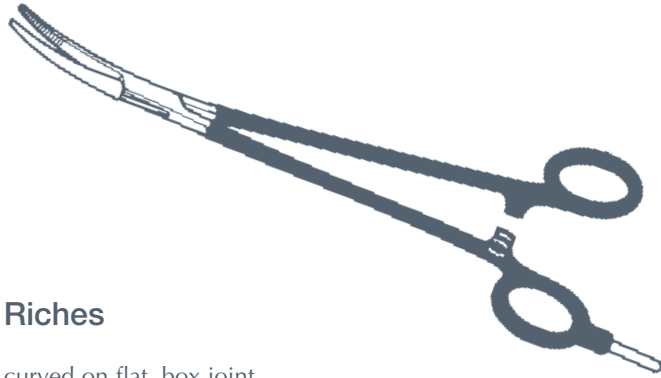

## Riches

curved on flat, box joint

1256/05 145mm

1256/10 200mm

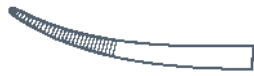

## Riches

curved on flat, screw joint

1257/05 125mm

1257/10 150mm

1257/15 180mm

1257/20 200mm

1257/25 230mm

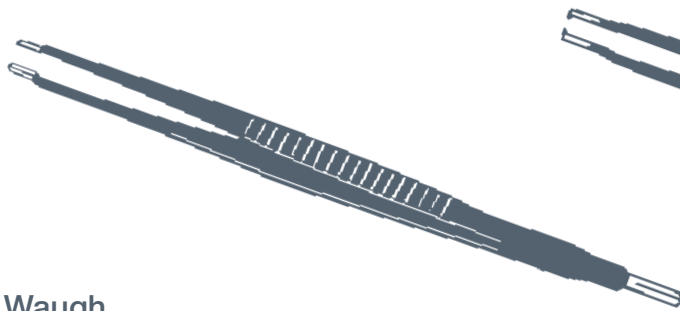

## Waugh

serrated

1260/05 180mm

1260/10 200mm

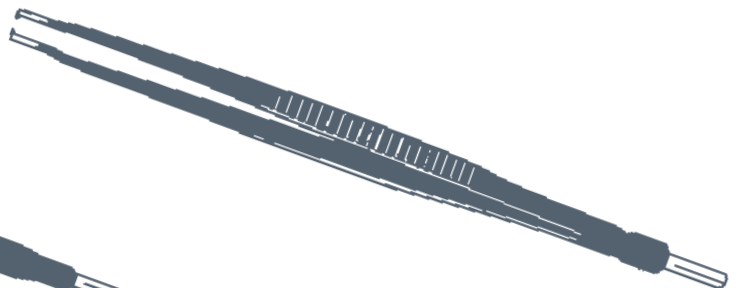

## Waugh

1/2 teeth

1261/05 180mm

1261/10 200mm

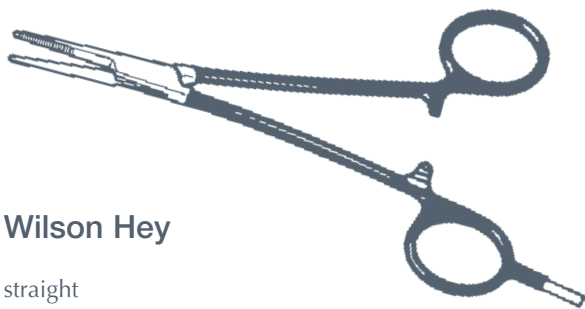

## Wilson Hey

straight

1267/05 145mm

1267/10 180mm

1267/15 230mm

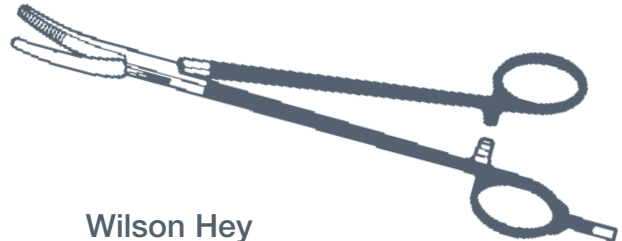

## Wilson Hey

curved

1268/05 145mm

1268/10 180mm

1268/15 230mm





## DIATHERMY SCISSORS



### Turner-Warwick

straight

1271/05 180mm

1271/10 215mm

1271/15 240mm

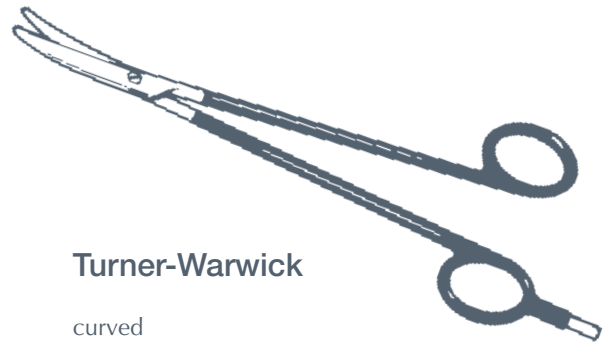

### Turner-Warwick

curved

1272/05 180mm

1272/10 215mm

1272/15 240mm

## DISSECTING FORCEPS

### Adson

serrated

1281/25 125mm

serrated, fine

1281/50 125mm

1281/55 180mm

serrated, ultra light

1281/75 180mm

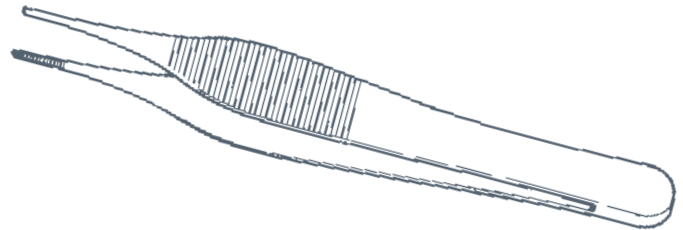

### Adson

1/2 teeth



1282/25 125mm

1/2 teeth, fine



1282/50 125mm

1282/55 180mm

1/2 teeth, ultra light



1282/75 180mm

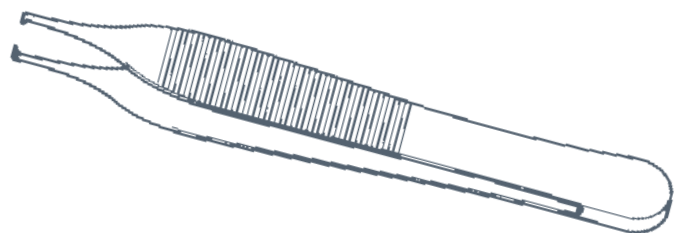

### Bickford

serrated

1283/05 230mm

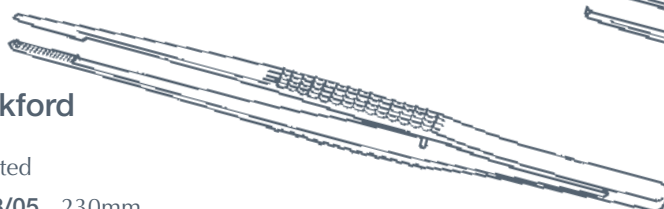

1/2 teeth



1284/05 230mm

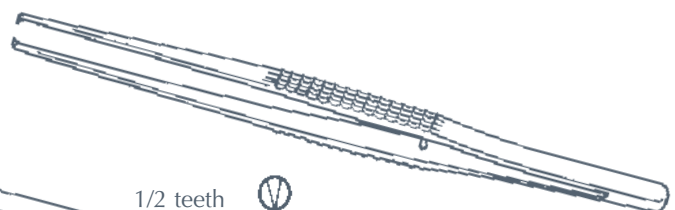



# DISSECTING FORCEPS

## Block End

fine serrated jaws, narrow flutes

- 1290/05 150mm
- 1290/10 180mm
- 1290/15 200mm

round serrated jaws, narrow flutes

- 1292/03 125mm
- 1292/05 150mm
- 1292/10 180mm
- 1292/15 200mm
- 1292/20 250mm

serrated jaws, broad flutes

- 1294/05 125mm
- 1294/10 150mm
- 1294/15 180mm
- 1294/20 200mm
- 1294/25 250mm
- 1294/30 300mm

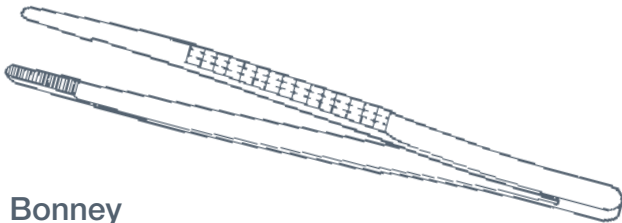
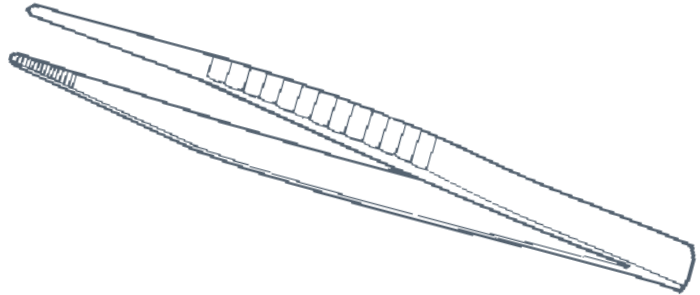
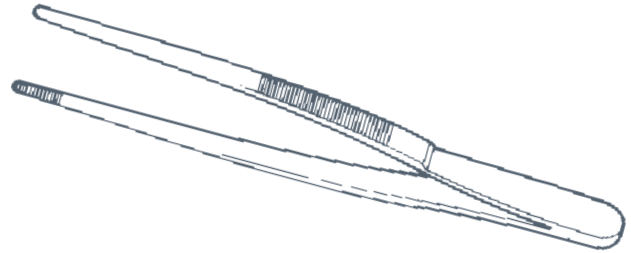
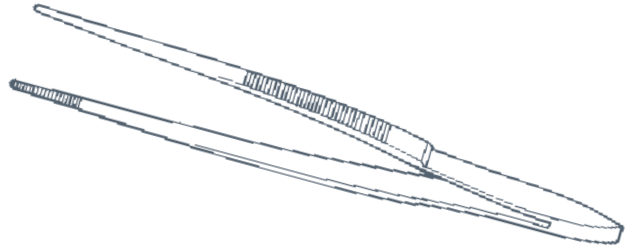

## Bonney

serrated

- 1301/25 180mm

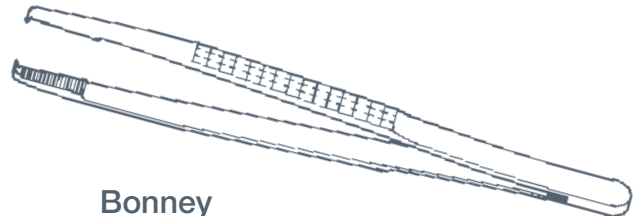

## Bonney

1/2 teeth



- 1301/50 180mm

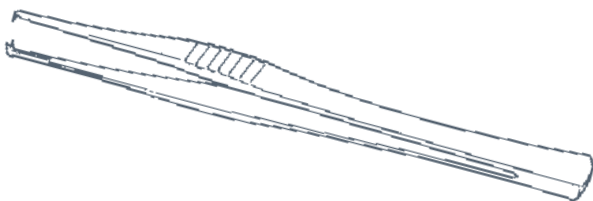

## Braithwaite

1/2 teeth



- 1303/05 140mm

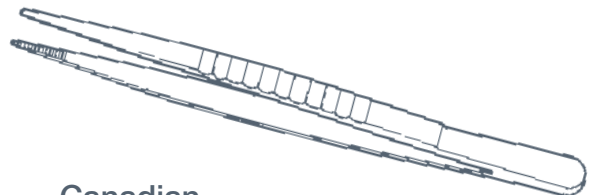

## Canadian

serrated jaws

- 1304/05 140mm
- 1304/10 150mm



DISSECTING FORCEPS

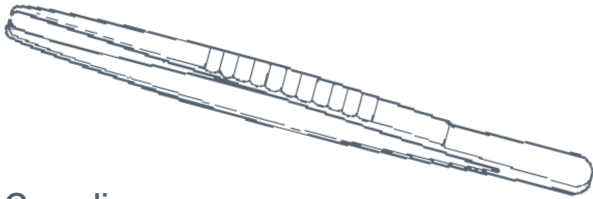

**Canadian**

- 2/3 teeth 
- 1305/05** 140mm
- 1305/10** 150mm

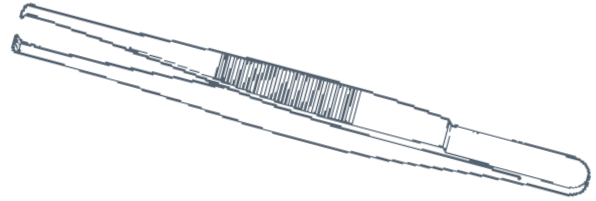

**Continental Pattern**

- |   |   |
|---|---|
| 1/2 teeth  | 2/3 teeth  |
| <b>1308/05</b> 105mm  | <b>1310/05</b> 125mm  |
| <b>1308/15</b> 125mm  | <b>1310/10</b> 150mm  |
| <b>1308/25</b> 150mm  | <b>1310/15</b> 160mm  |
| <b>1308/30</b> 160mm  | <b>1310/20</b> 175mm  |
| <b>1308/35</b> 175mm  | <b>1310/25</b> 200mm  |
| <b>1308/40</b> 200mm  | <b>1310/30</b> 250mm  |
| <b>1308/45</b> 250mm  | <b>1310/35</b> 300mm  |
| <b>1308/50</b> 300mm  |   |

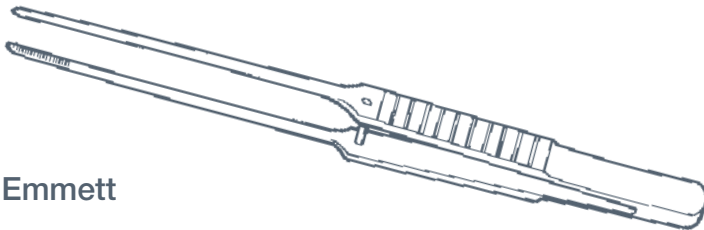

**Emmett**

- serrated jaws
- 1315/05** 200mm

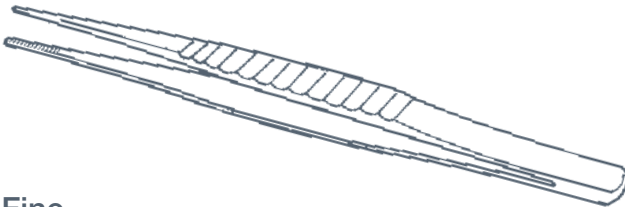

**Fine**

- serrated
- 1316/05** 125mm

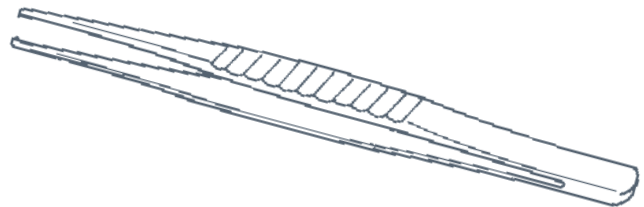

**Fine**

- 1/2 teeth 
- 1317/05** 125mm

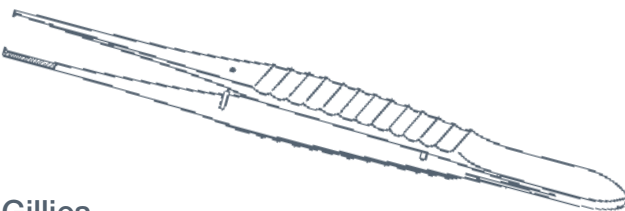

**Gillies**

- 1/2 teeth 
- 1318/05** 150mm

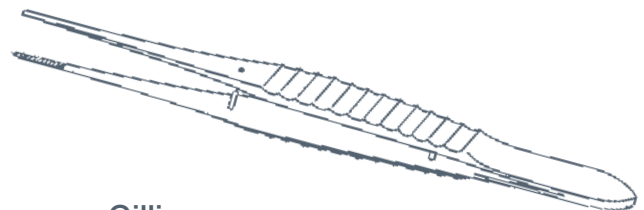

**Gillies**

- serrated
- 1318/20** 150mm



# DISSECTING FORCEPS

## Iris

straight, serrated  
**1319/05** 90mm  
**1319/10** 115mm

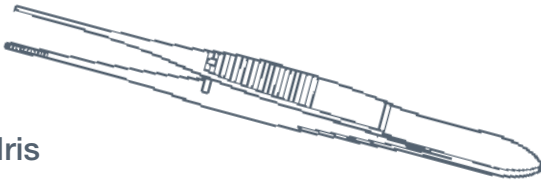

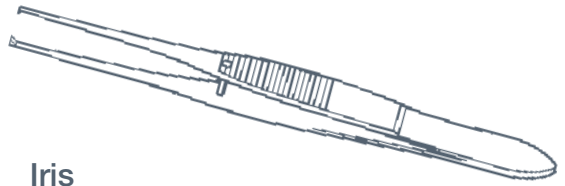

## Iris

straight, 1/2 teeth   
**1320/05** 90mm  
**1320/10** 115mm



## Jeans

serrated jaws  
**1321/05** 140mm  
 1/2 teeth   
**1322/05** 140mm  
**1322/10** 180mm  
 2/3 teeth   
**1323/10** 180mm

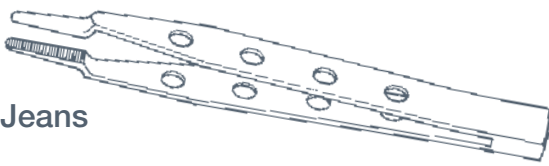

## Lanes

1/2 teeth   
**1326/05** 125mm  
**1326/10** 140mm  
**1326/15** 180mm  
**1326/20** 200mm

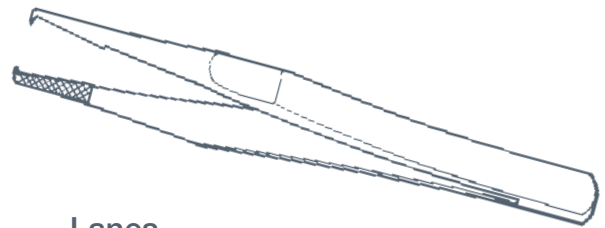

## Lanes

2/3 teeth   
**1327/05** 125mm  
**1327/10** 140mm  
**1327/15** 180mm  
**1327/20** 200mm

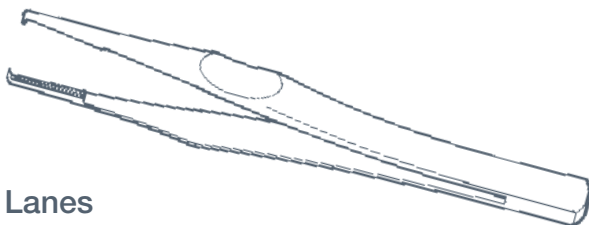

## Leedham Green

**1329/25** 2/3 teeth, 145mm   
**1329/50** 3/4 teeth, 145mm 



## McIndoe

serrated  
**1334/25** 150mm

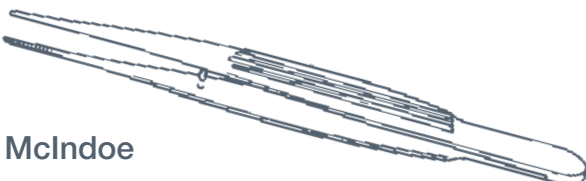

## McIndoe

1/2 teeth   
**1334/50** 150mm

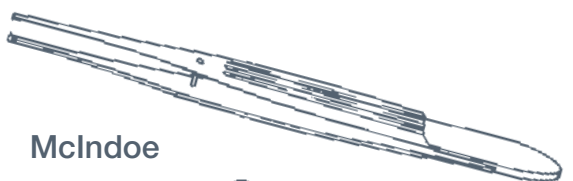





DISSECTING FORCEPS

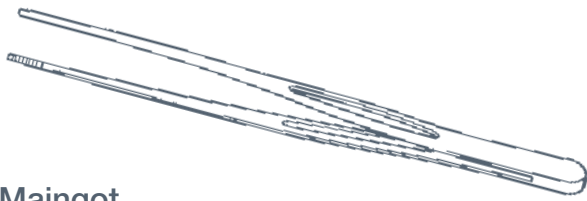

**Maingot**

serrated tips, fenestrated grip  
1337/05 280mm

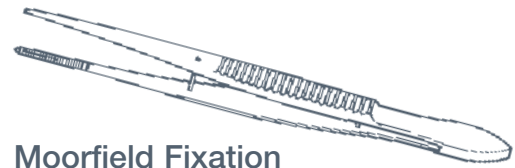

**Moorfield Fixation**

fine points  
1339/05 90mm

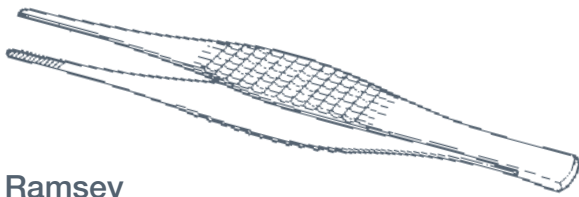

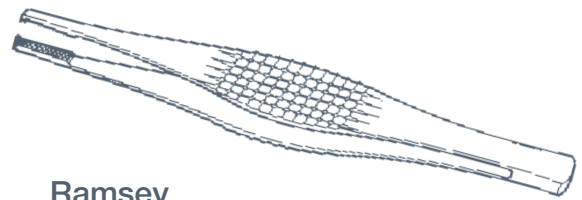

**Ramsey**

serrated  
1344/05 180mm



**Ramsey**

1/2 teeth   
1345/05 180mm  
2/3 teeth   
1346/05 180mm

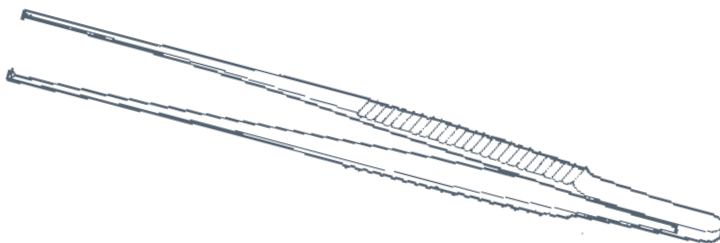

**St Marks Hospital**

serrated  
1352/05 290mm  
1/2 teeth   
1353/05 290mm

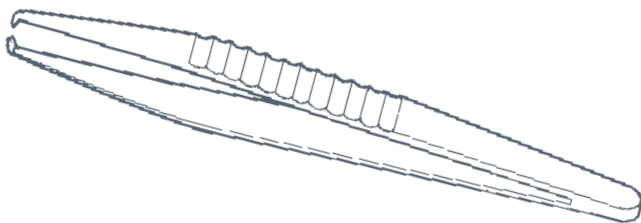

**Treves**

1/2 teeth   
1360/05 125mm  
1360/10 150mm  
1360/15 180mm  
1360/20 200mm  
1360/25 250mm

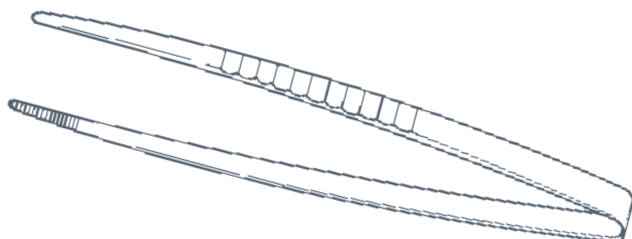

**Turn-Over-End**

serrated jaws, broad flutes  
1363/05 125mm  
1363/10 150mm



## DISSECTING FORCEPS

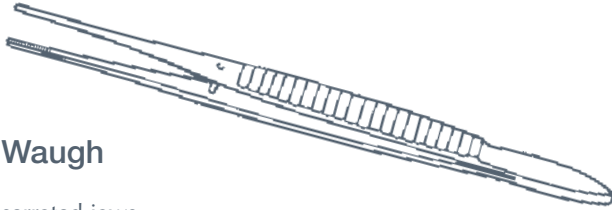

### Waugh

serrated jaws

1366/05 150mm

1366/08 180mm

1366/10 200mm

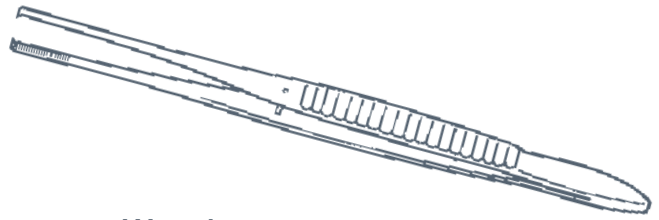

### Waugh

1/2 teeth



1367/05 150mm

1367/08 180mm

1367/10 200mm

## DISSECTORS

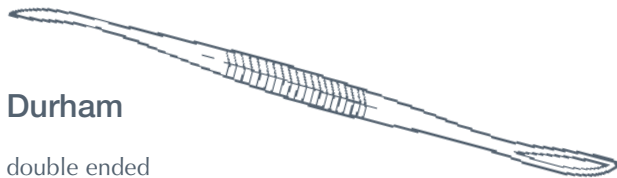

### Durham

double ended

1382/05 190mm

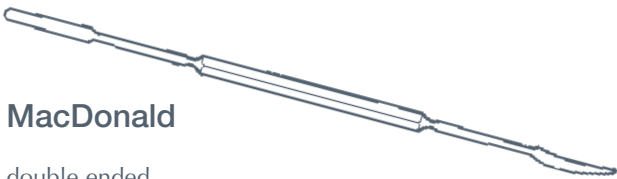

### MacDonald

double ended

1388/05 190mm

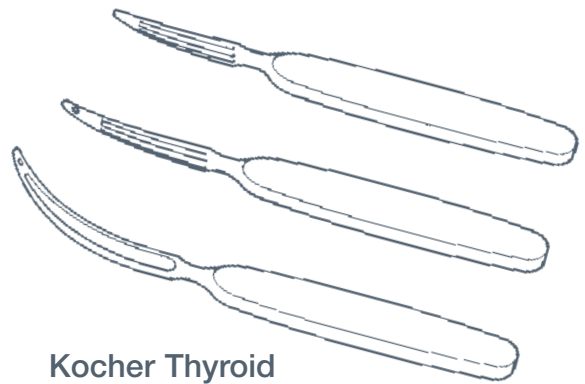

### Kocher Thyroid

curved

1385/05 160mm

1385/10 165mm

1385/15 180mm

### Watson Cheyne

fine with probe

1391/05 125mm

1391/10 180mm

1391/15 230mm

1391/20 255mm

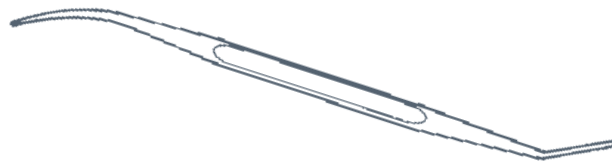

## DRESSING FORCEPS

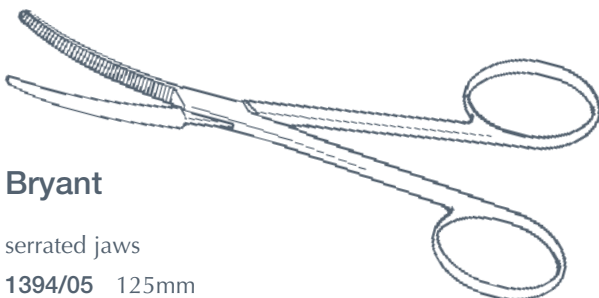

### Bryant

serrated jaws

1394/05 125mm

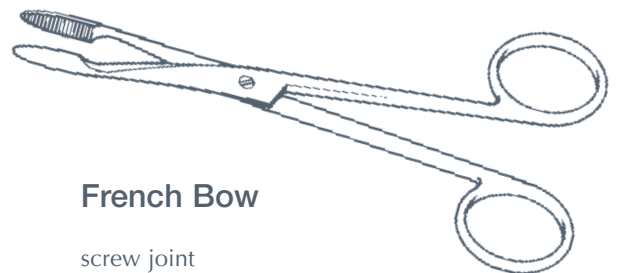

### French Bow

screw joint

1398/05 125mm

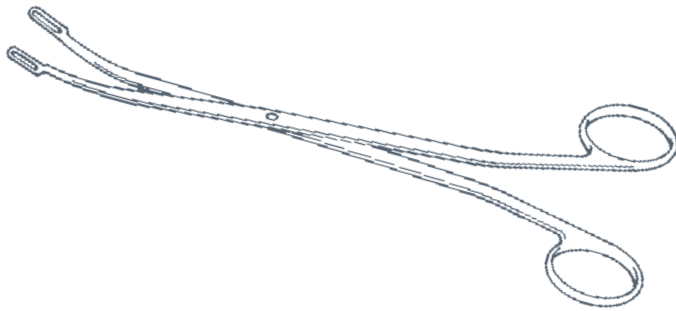

## GALLSTONE FORCEPS

### Desjardins

screw joint

1417/05 small, 220mm

1417/10 large, 240mm

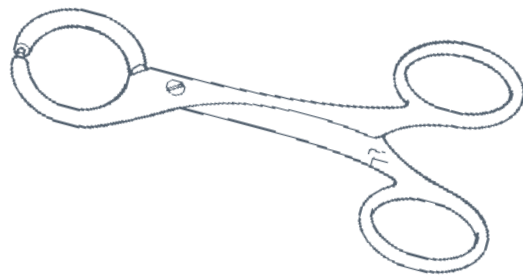

## HERNIA FORCEPS

### Collingwood Stewart

ring bladed, screw joint

1433/05 140mm

## INSTRUMENT PINS

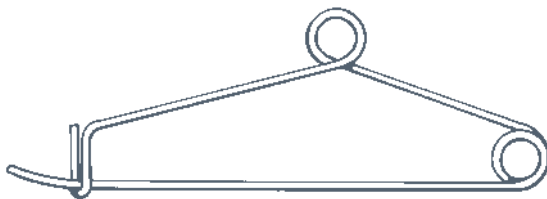

### Mayo

plain, made in Pakistan

1436/05 100mm

1436/10 150mm

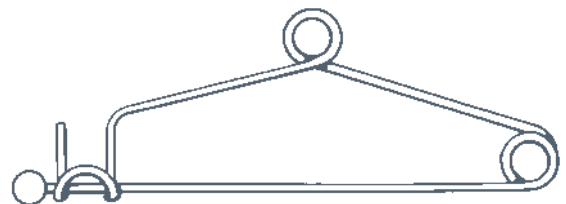

### Mayo

with ball end, made in Pakistan

1437/05 100mm

1437/10 150mm

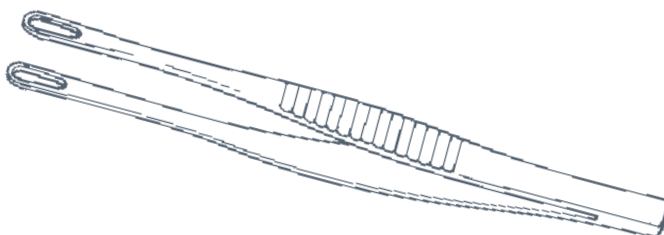

## INTESTINAL FORCEPS

### Denis Brown

1439/05 190mm



# INTRODUCING FORCEPS

## Magill

screw joint

1440/05 adult, 230mm

1440/10 child, 190mm

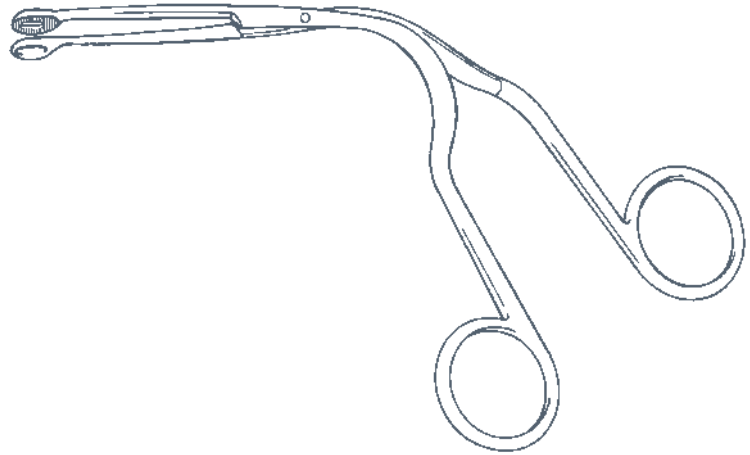

# KNIVES

## Brain

solid forged

1445/05 200mm blade

1445/10 225mm blade

1445/15 250mm blade

1445/20 300mm blade

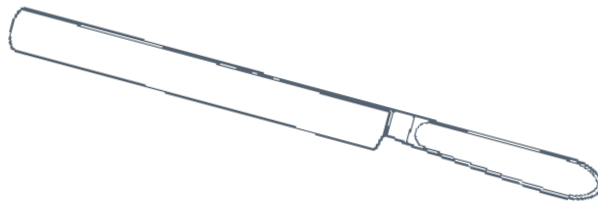

## Cartilage

solid forged

1448/05 200mm, 70mm blade

1448/10 215mm, 90mm blade

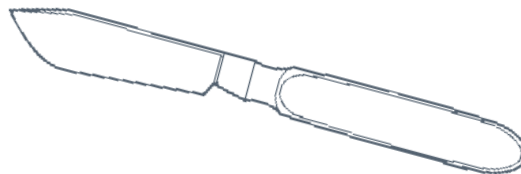

## Catlin

solid forged

1451/05 245mm, 120mm blade

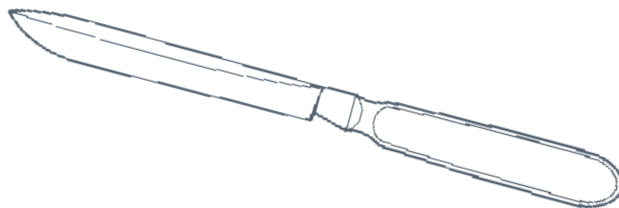

## Liston Amputation

solid forged

1454/05 100mm blade

1454/10 125mm blade

1454/15 150mm blade

1454/20 180mm blade

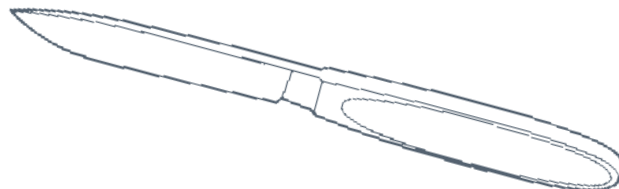

## Paget

1455/05 140mm

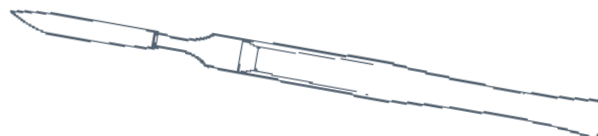



MOUTH GAGS

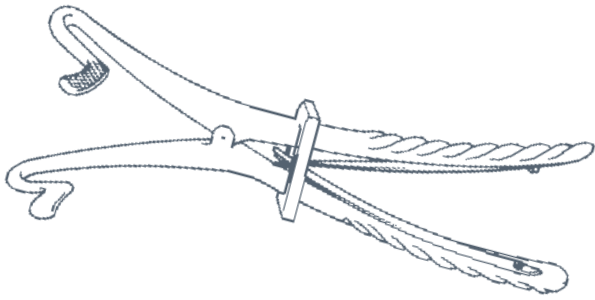

Fergusson

Ackland jaw

1482/05 adult, 200mm

1482/10 child, 170mm

ordinary jaw

1483/05 adult, 200mm

1483/10 child, 170mm

NEEDLEHOLDERS

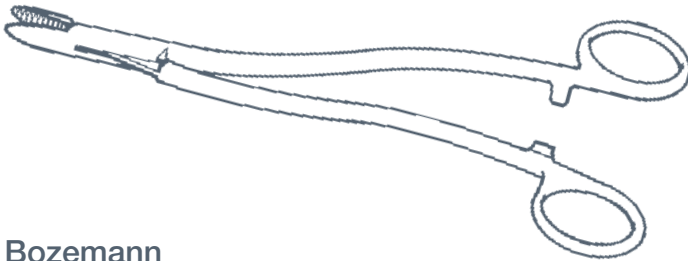

Bozemann

double curve, serrated jaws

1490/05 200mm

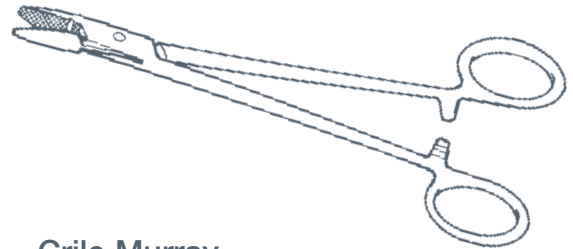

Crile Murray

serrated jaws

1493/05 145mm

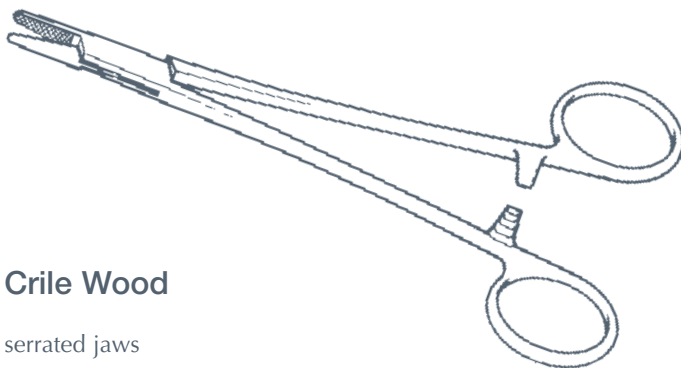

Crile Wood

serrated jaws

1496/05 150mm

1496/10 180mm

1496/15 200mm

1496/20 230mm

1496/25 255mm

1496/30 305mm

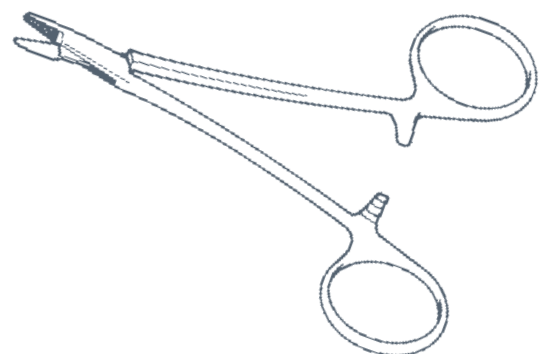

Derf

serrated jaws

1497/05 120mm





GEN

NEEDLEHOLDERS

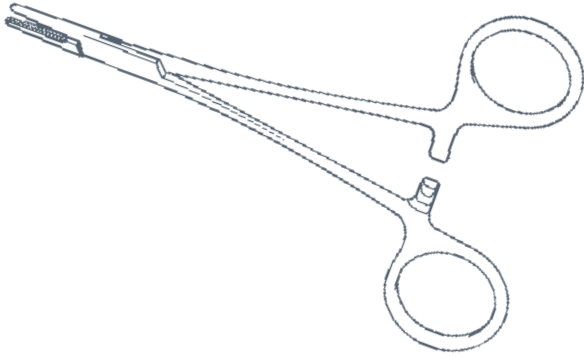

**Halsey**

serrated jaws  
1499/05 125mm

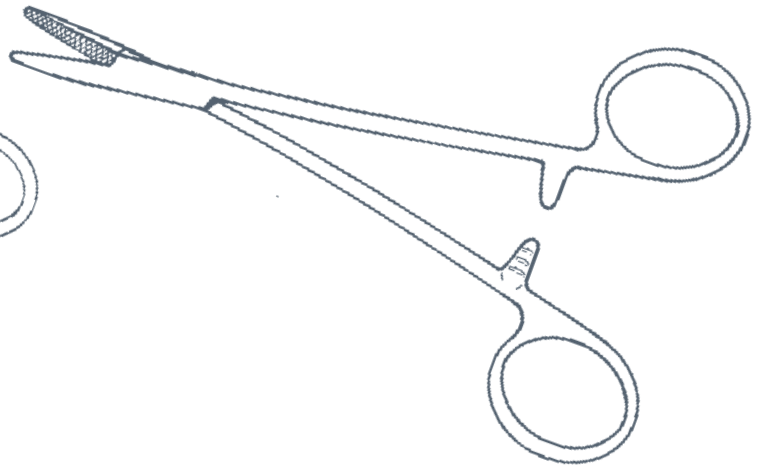

**Hegar**

serrated jaws  
1505/05 200mm

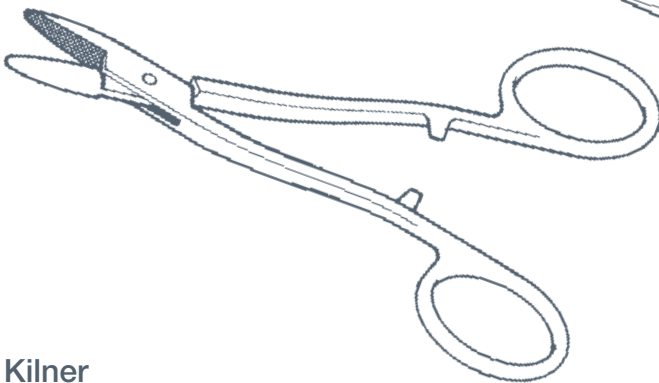
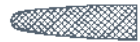

**Kilner**

serrated jaws  
1508/05 135mm  
1508/10 165mm

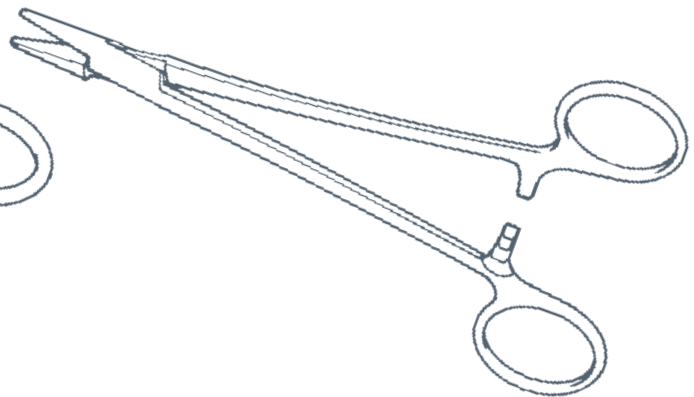

**Lawrance**

lightweight, serrated jaws  
1511/05 150mm

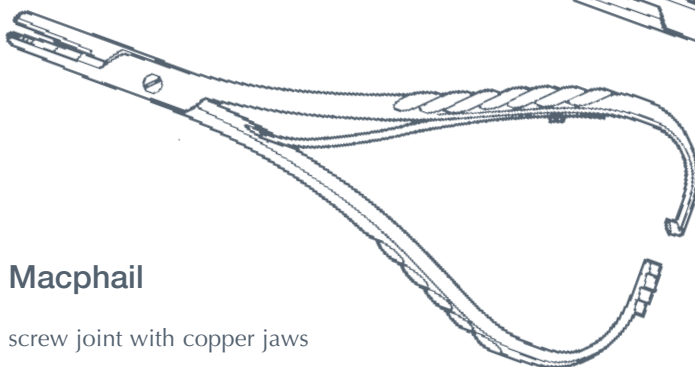

**Macphail**

screw joint with copper jaws  
1514/05 150mm  
1514/10 180mm  
1514/15 200mm

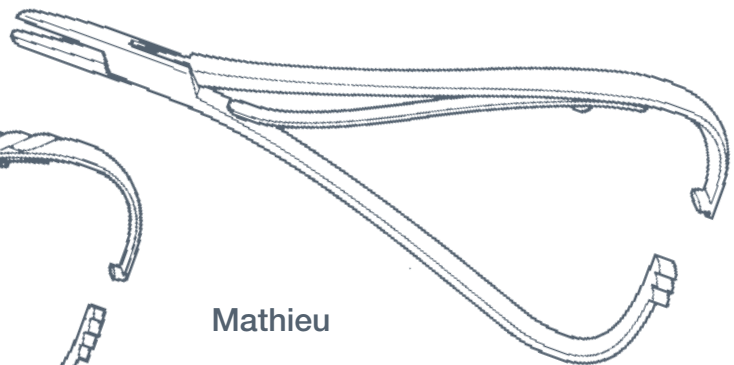

**Mathieu**

serrated jaws  
1517/05 170mm  
1517/10 200mm





NEEDLEHOLDERS

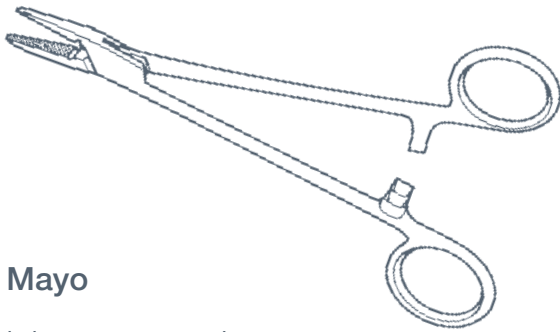

**Mayo**

light pattern, serrated jaws  
1520/05 150mm

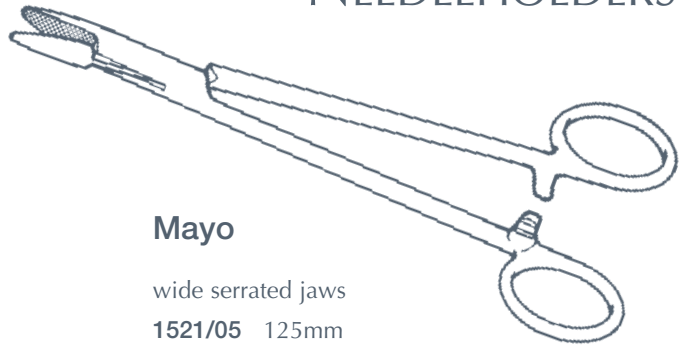

**Mayo**

wide serrated jaws  
1521/05 125mm  
1521/10 140mm  
1521/18 160mm  
1521/28 185mm  
1521/35 200mm  
1521/40 230mm  
1521/45 255mm  
1521/50 305mm

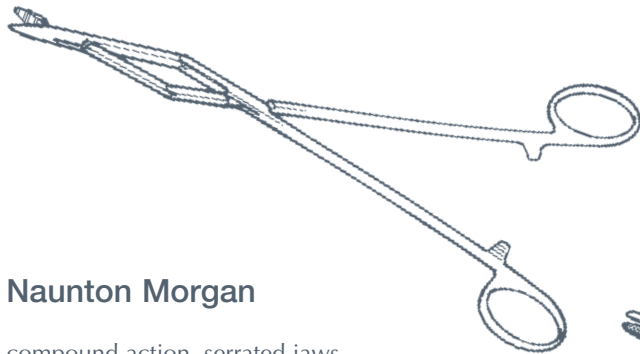

**Naunton Morgan**

compound action, serrated jaws  
1527/05 185mm  
1527/10 250mm

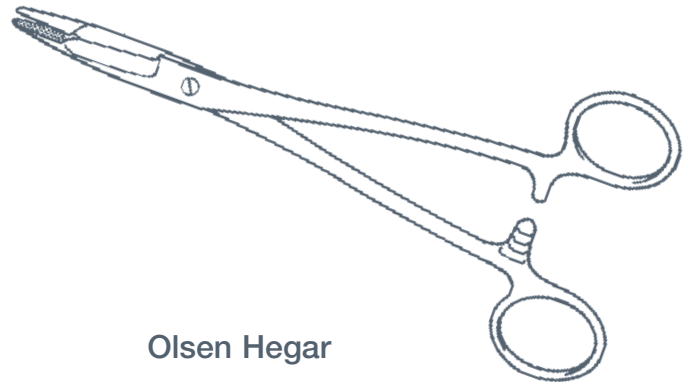

**Olsen Hegar**

serrated jaws  
1528/05 140mm  
1528/10 190mm

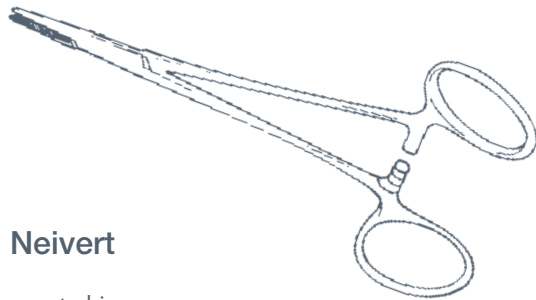

**Neivert**

serrated jaws  
1525/05 125mm

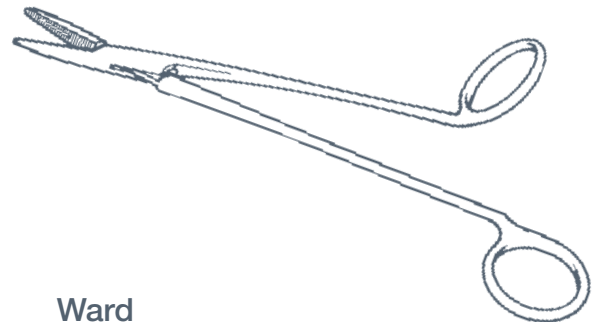

**Ward**

serrated, fenestrated jaws  
1535/05 180mm

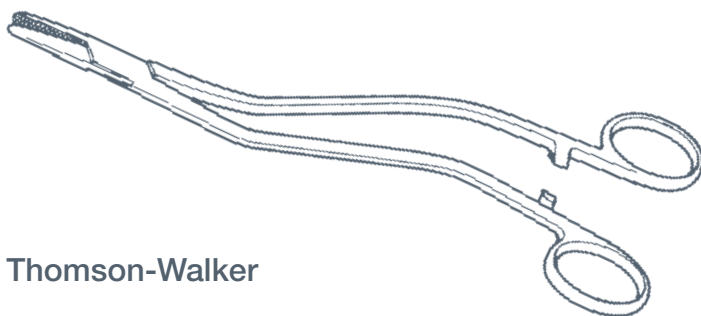

**Thomson-Walker**

serrated jaws  
1530/05 200mm





# NEEDLEHOLDERS, TUNGSTEN CARBIDE

The needleholders shown on pages 26-28 have jaws made from tungsten carbide, which is the hardest and longest lasting material used in surgical instruments. The configuration of the jaws gives the best possible grip, and the gold bows allow clear and positive identification in the operating theatre.

In the event of accidental damage, repairs can be made quickly and economically.

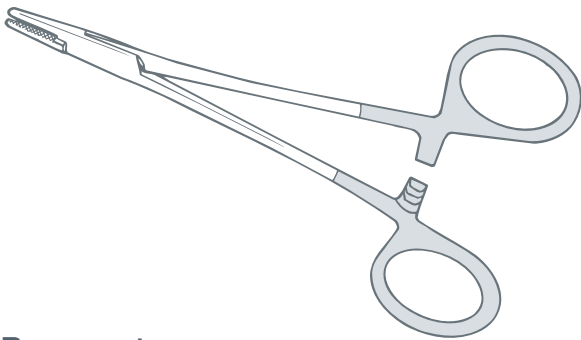

### Baumgartner

1545/05 125mm

1545/10 140mm

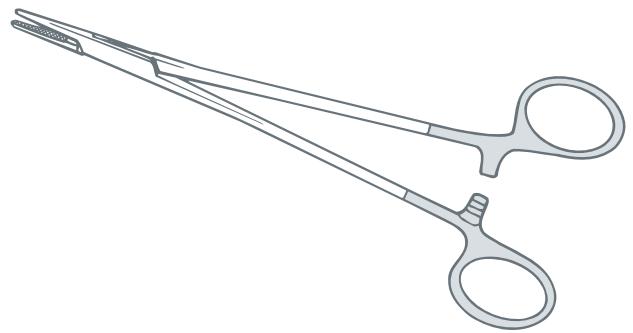
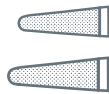

### Crile Wood

1551/05 150mm

1551/10 180mm

1551/15 200mm

1551/20 230mm

1551/25 255mm

1551/30 305mm

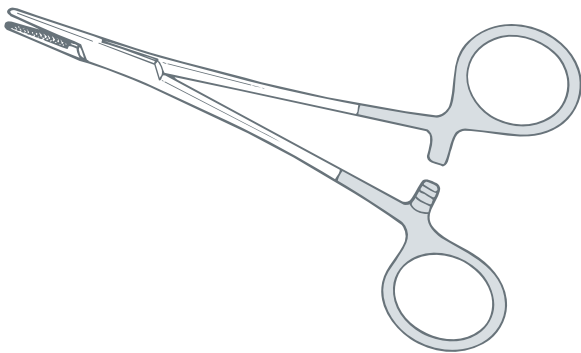
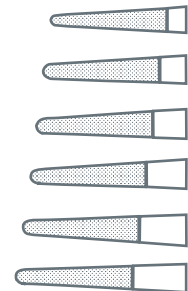

### DeBakey

1554/05 180mm

1554/10 200mm

1554/15 230mm

1554/20 250mm

1554/25 305mm

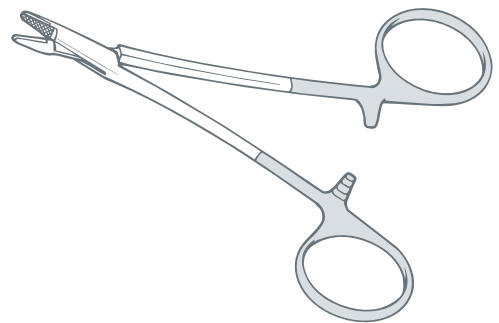
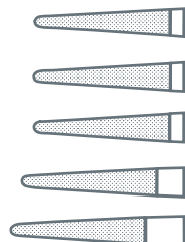

### Derf

1556/05 120mm







NEEDLEHOLDERS,  
TUNGSTEN CARBIDE

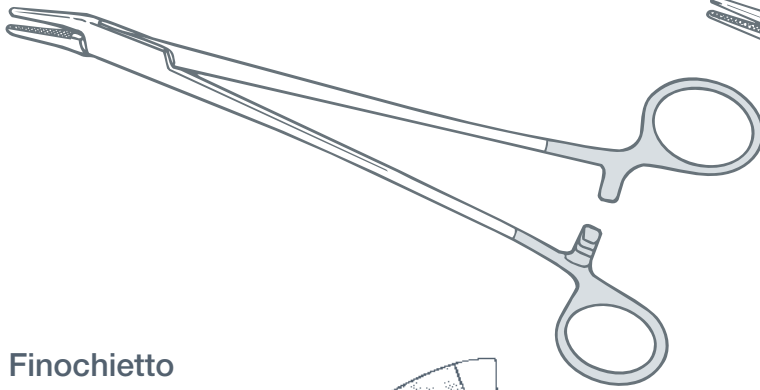

**Finochietto**

1557/05 200mm

1557/10 265mm

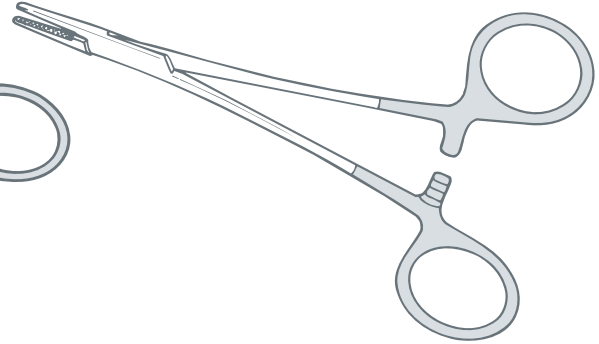
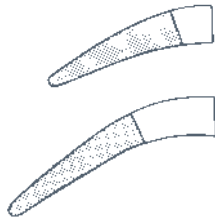

**Halsey**

1559/05 125mm



**Kilner**

1561/05 135mm

1561/10 165mm

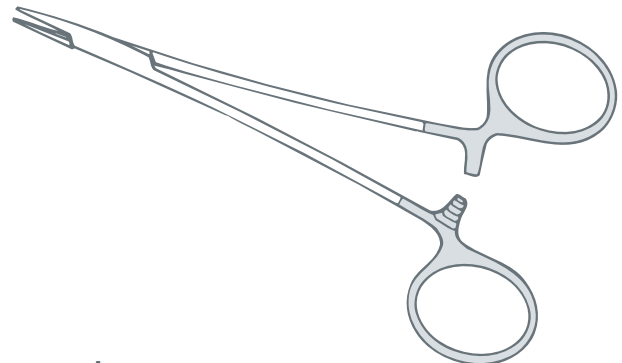

**Lawrance**

1567/05 150mm

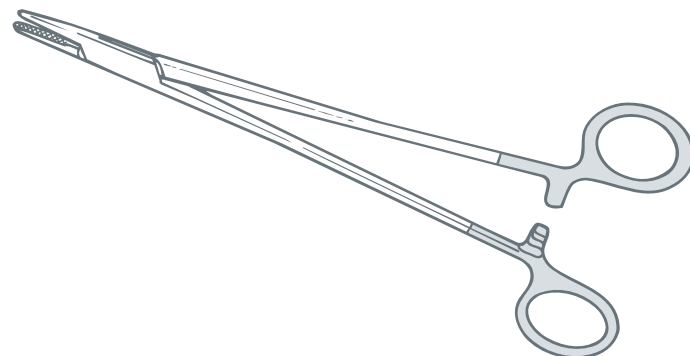

**Mayo**

1576/05 125mm

1576/10 140mm

1576/18 160mm

1576/30 185mm

1576/40 200mm

1576/45 230mm

1576/50 255mm

1576/55 305mm

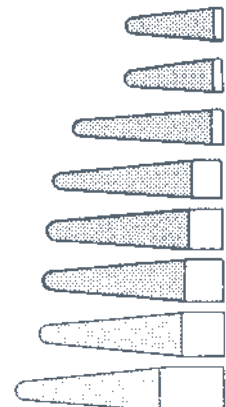



GEN

# NEEDLEHOLDERS, TUNGSTEN CARBIDE

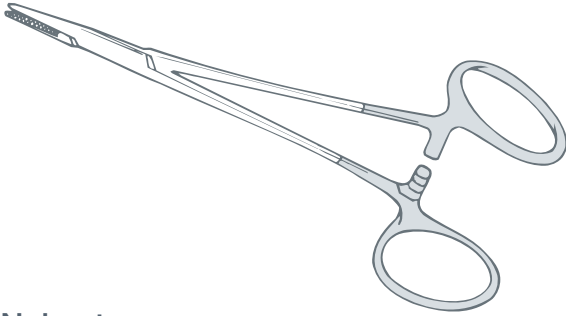

### Neivert

1577/05 125mm

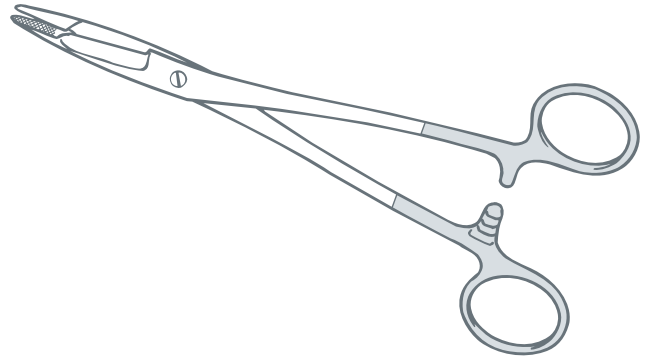

### Olsen Hegar

1578/05 140mm



1578/10 190mm



### Ryder

French eye

1579/05 125mm



1579/10 150mm



1579/15 180mm



1579/20 200mm



1579/25 230mm



1579/30 255mm

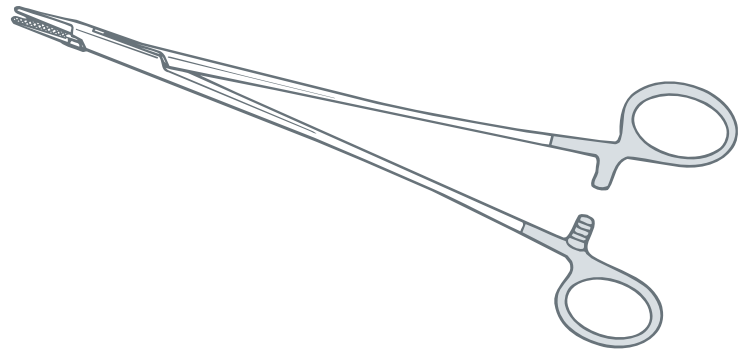

### Thomson-Walker

1585/05 200mm

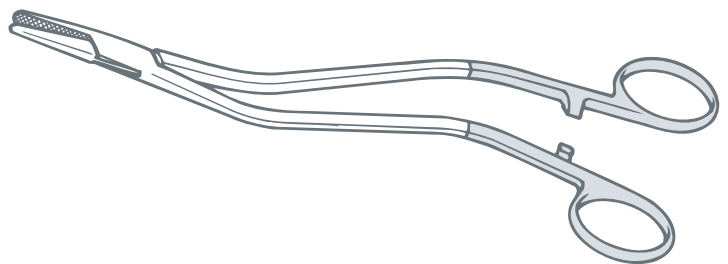

### Webster

smooth jaws

1588/05 130mm

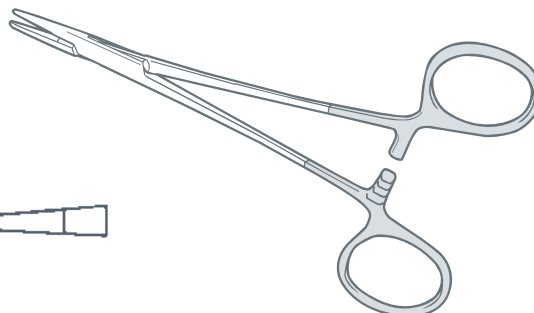



## NEEDLES

GEN

**Aneurysm**

small curve  
1591/05 145mm

**Cooper**

1593/05 190mm

**Deschamps**

curved to left  
1595/25 270mm



curved to right  
1595/50 270mm

**Dupuytren**

curved to left  
1597/25 170mm



curved to right  
1597/50 170mm

**Jolls**

200mm  
1599/25 fig 1  
1599/50 fig 2  
1599/75 fig 3

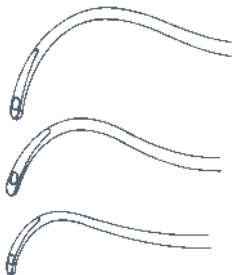
**Symes**

1601/05 165mm



PLASTER INSTRUMENTS



**Bohler Bender**

1612/05 255mm

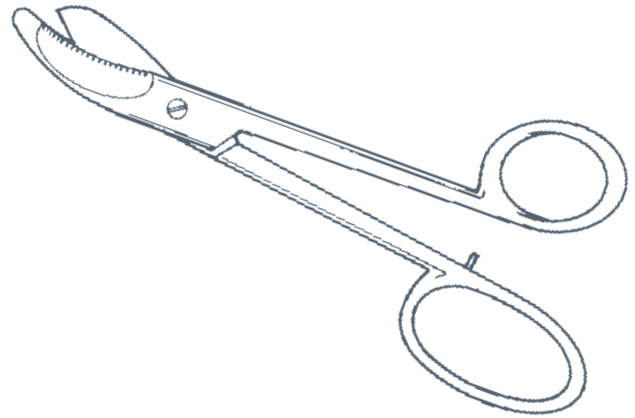

**Bruns/Bohler Shears**

1614/05 240mm

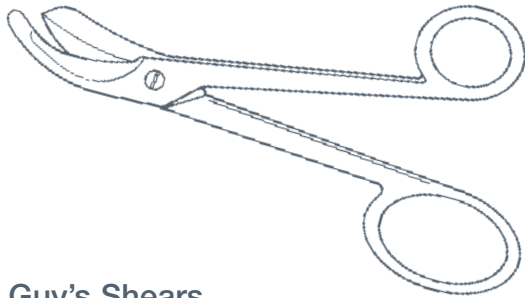

**Guy's Shears**

probe end  
1615/05 250mm

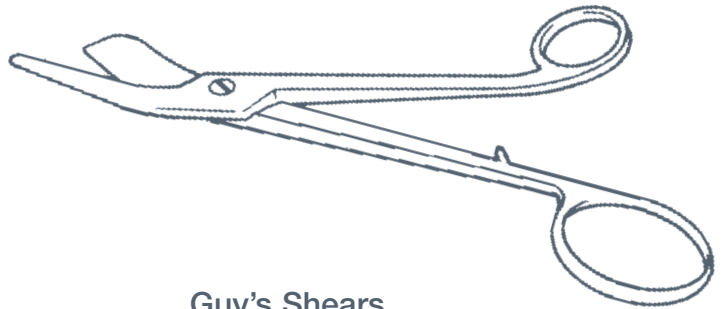

**Guy's Shears**

flattened end  
1616/05 290mm

**Hennig Spreader**

1619/05 280mm

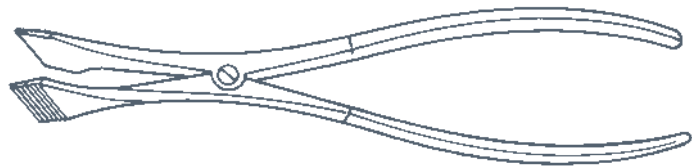

**Stille-Lorenz Shears**

1625/05 230mm  
1625/10 260mm  
1625/15 370mm

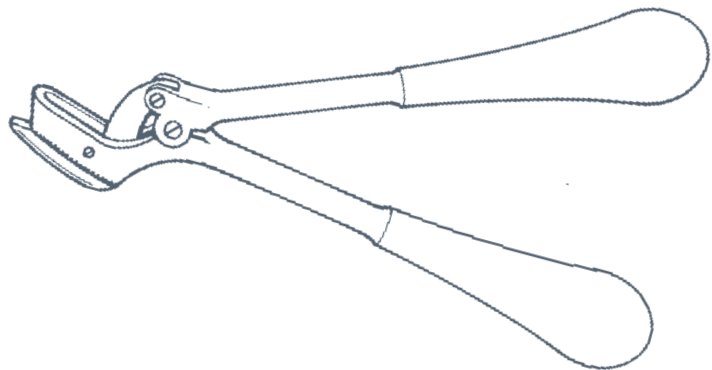

POST MORTEM  
INSTRUMENTS

GEN

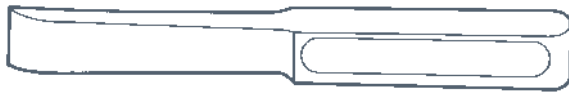
**Chisel**

1635/05 19mm x 175mm

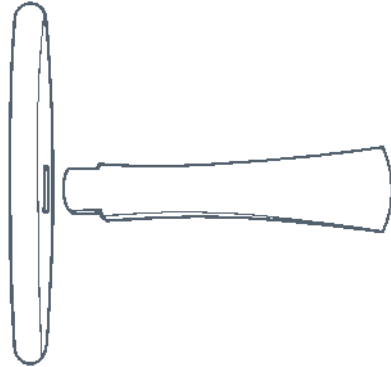
**Cross Handle Chisel**

1636/05 25mm blade

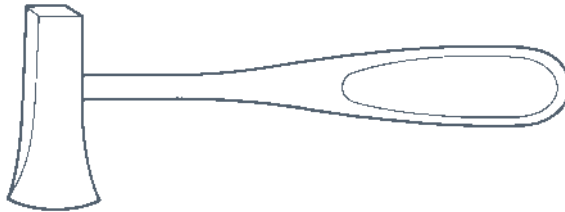
**Hammer**

wrench end

1638/05 32mm blade

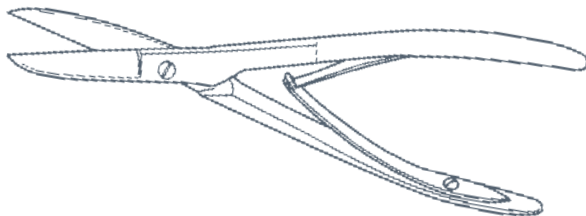
**Shears**

skull

1640/05 230mm

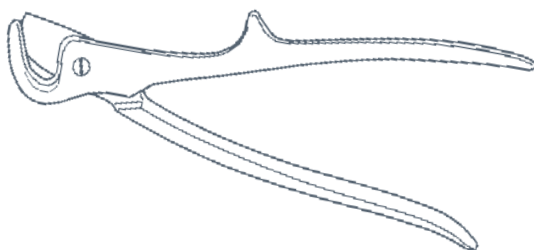
**Shears**

rib

1641/05 210mm

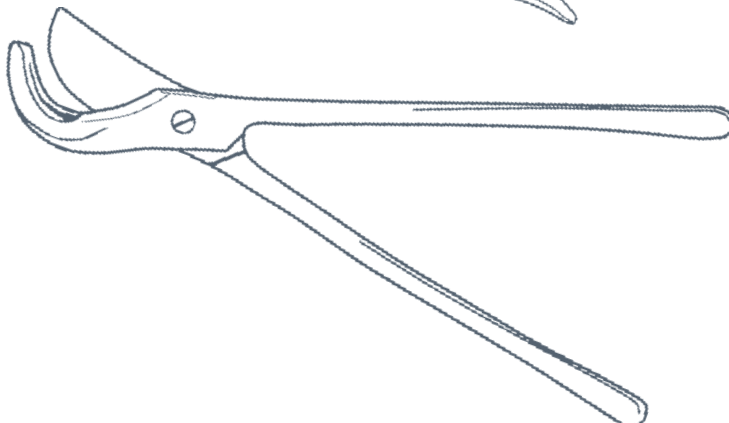
**Shears**

pollocks rib

1642/05 320mm



# POST MORTEM INSTRUMENTS



### Knife

solid forged single edge

**1644/05** 210mm, 85mm blade

**1644/10** 220mm, 95mm blade

**1644/15** 235mm, 108mm blade

**1644/20** 245mm, 120mm blade



### Spine Wrench

**1647/05** 215mm

## PROBES

### Brodie

grooved, probe end

**1650/10** 130mm

**1650/15** 145mm

**1650/20** 160mm

**1650/25** 180mm



### Nickel Silver

with eye, made in Pakistan

**1653/05** 125mm

**1653/10** 150mm

**1653/15** 180mm

**1653/20** 200mm

**1653/25** 250mm

**1653/30** 300mm



### Sinus

silver

**1656/05** 150mm





## RETRACTORS

GEN

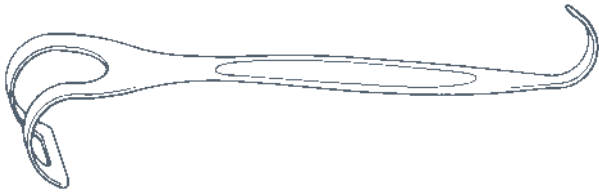
**Canny Ryall**

fenestrated blade

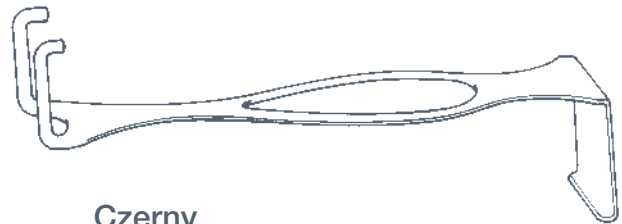
**1659/05** 190mm, 16mm x 25mm blade**1659/10** 190mm, 19mm x 28mm blade**1659/15** 200mm, 25mm x 32mm blade**Czerny**

double ended

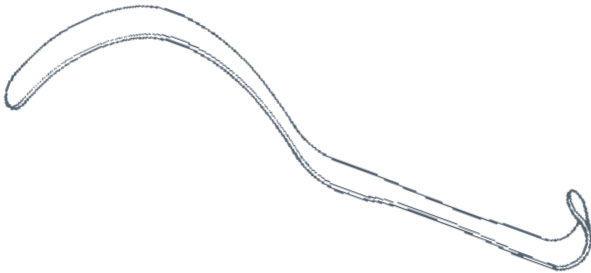
**1662/05** 180mm**Deaver Abdominal**

flat handles

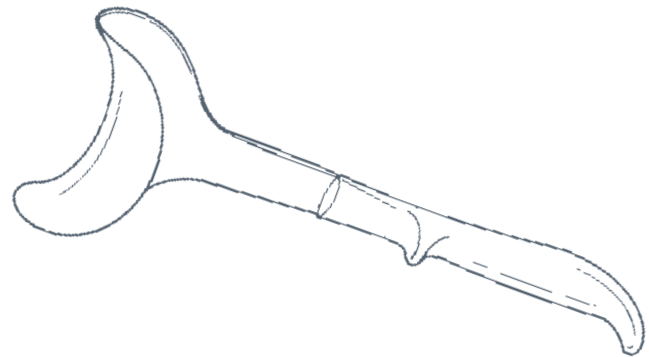
**1665/05** No. 1, 305mm, 25mm blade**1665/10** No. 2, 330mm, 25mm blade**1665/15** No. 3, 305mm, 38mm blade**1665/20** No. 4, 305mm, 50mm blade**1665/25** No. 5, 305mm, 75mm blade**1665/95** set of 5**Doyen**

250mm overall length

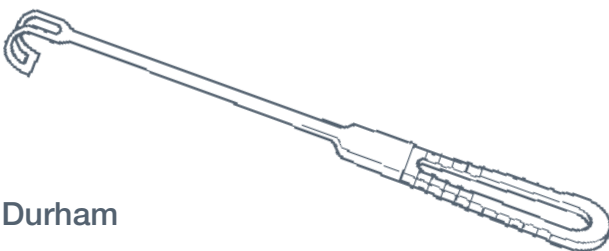
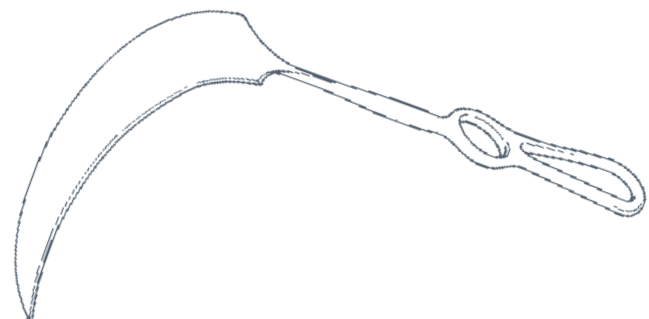
**1669/05** 50mm x 85mm blade**Durham****1672/05** 10mm blade**1672/10** 16mm blade**1672/15** 22mm blade**Kelly**

270mm overall length

**1686/05** 185mm x 38mm blade**1686/10** 185mm x 57mm blade



GEN

## RETRACTORS

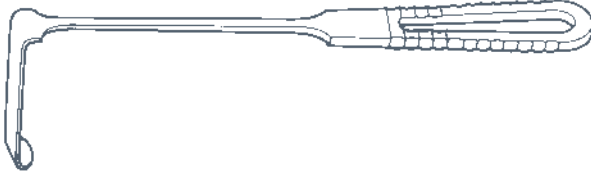

### Langenbeck

single ended

**1692/05** 22mm x 6mm blade

**1692/10** 45mm x 13mm blade

**1692/15** 65mm x 25mm blade

**1692/20** 90mm x 20mm blade

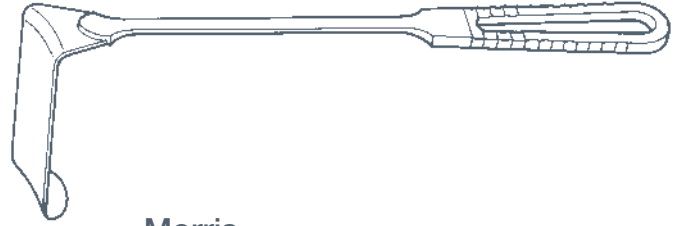

### Morris

single ended

**1696/05** 245mm, 70mm x 40mm blade

**1696/10** 245mm, 70mm x 50mm blade

**1696/15** 245mm, 70mm x 65mm blade



### Morris

double ended

**1697/05** 215mm, 30mm x 50mm and  
40mm x 50mm blades

**1697/10** 215mm, 45mm x 50mm and  
50mm x 50mm blades

**1697/15** 215mm, 60mm x 50mm and  
65mm x 50mm blades



### Moynihan

single ended

**1699/05** 215mm, 13mm x 22mm blade

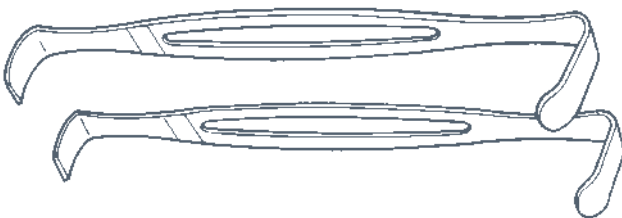

### Parker-Langenbeck (US Army)

set of 2

**1707/05** 210mm

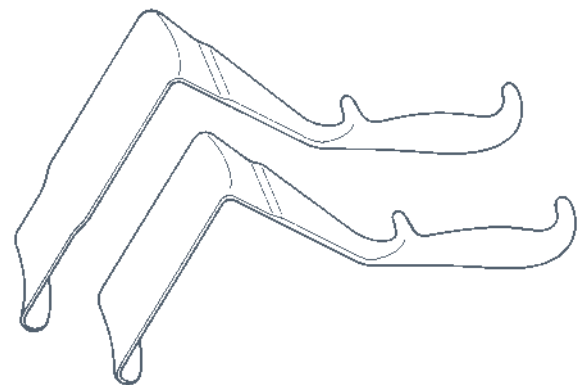

### St Marks Hospital

with lip

**1713/05** 125mm x 60mm blade

**1713/10** 175mm x 60mm blade





## RETRACTORS

GEN

**Tracheal Hook**

single

1716/25 blunt, 150mm

1716/50 sharp, 150mm

**Tracheal Hook**

double

1717/25 blunt, 180mm

1717/50 sharp, 180mm

**Volkmann**

blunt, 220mm

1719/05 1 prong

1719/10 2 prong

1719/15 3 prong

1719/20 4 prong

1719/25 6 prong



sharp, 220mm

1721/05 1 prong

1721/10 2 prong

1721/15 3 prong

1721/20 4 prong

1721/25 6 prong

**Walton**

copper, malleable

1724/05 305mm x 13mm

1724/10 305mm x 19mm

1724/15 305mm x 25mm

1724/20 305mm x 32mm

1724/25 305mm x 38mm

1724/30 305mm x 50mm





GEN

# RETRACTORS, AMPUTATION

## Blake Flap

1727/05 240mm diameter

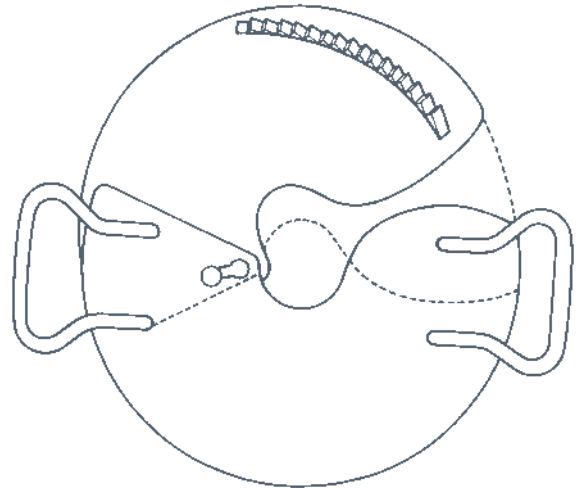

# RETRACTORS, SELF-RETAINING

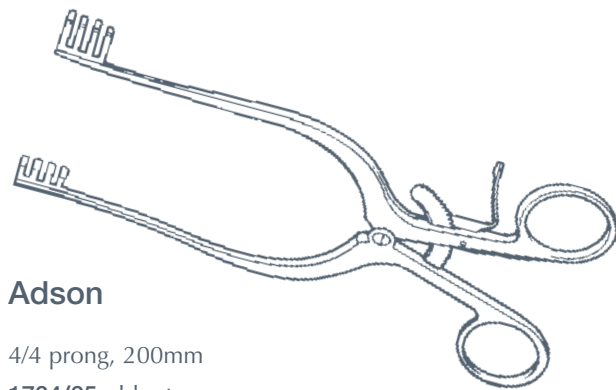

## Adson

4/4 prong, 200mm

1734/25 blunt

1734/50 sharp

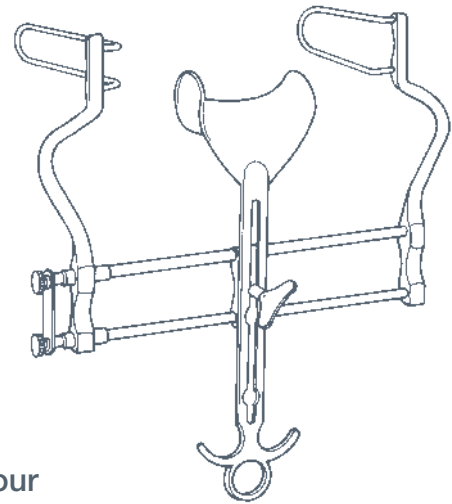

## Balfour

fenestrated end blades 180mm,

63mm x 35mm blades

1737/05

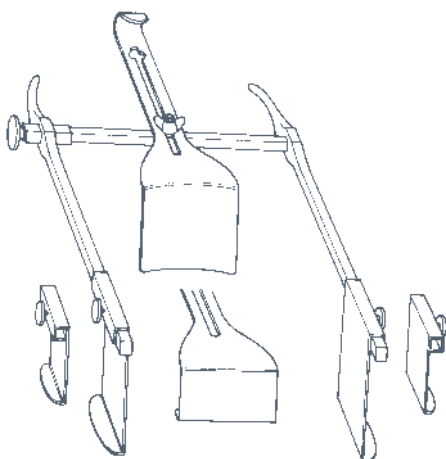

## Goligher

complete 165mm, 2 centre blades,

2 lateral blades 51mm deep and

2 lateral blades 100mm deep

1753/05

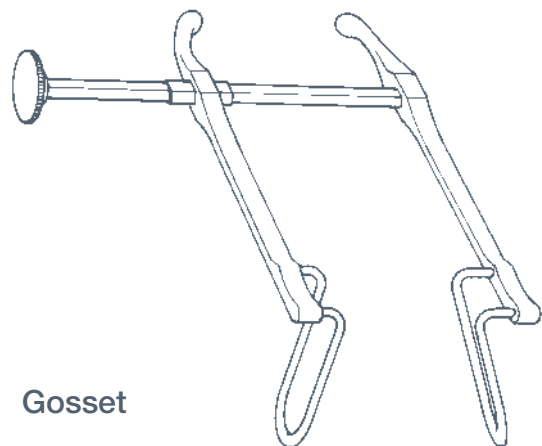

## Gosset

2 blades

1755/05 large

1755/10 small



RETRACTORS,  
SELF-RETAINING

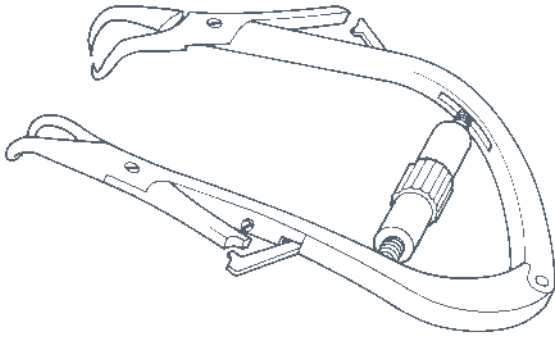

**Jolls Thyroid**

1758/05 150mm

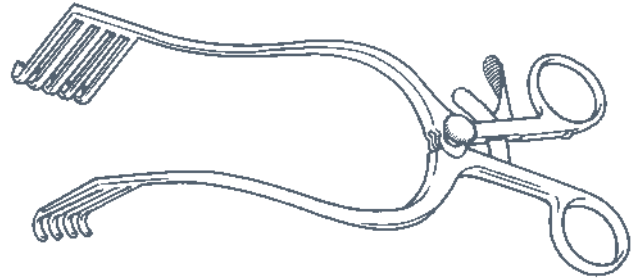

**Norfolk and Norwich**

cam rack, 4/5 teeth

1770/05 215mm, 50mm blades

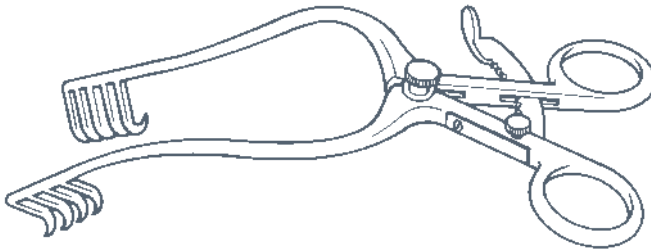

**Travers**

4/5 teeth

1778/05 200mm, 19mm x 25mm and  
25mm x 25mm blades

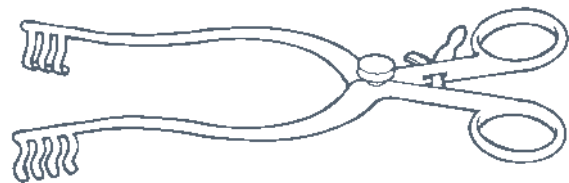

**Weislander**

3/4 teeth

1780/05 140mm

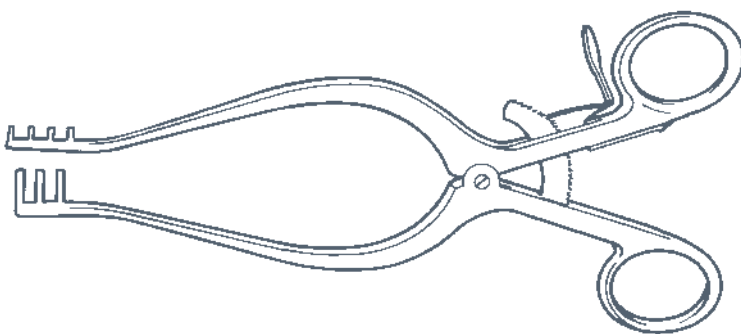

**Weitlaner**

blunt

1782/05 200mm

1782/10 240mm

sharp

1783/05 200mm

1783/10 240mm

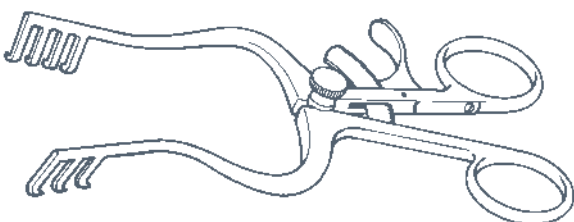

**West**

sharp

1785/05 140mm



GEN

## RING CUTTER

complete, made in Pakistan

1788/25 165mm

spare blade

1788/50 carbon steel

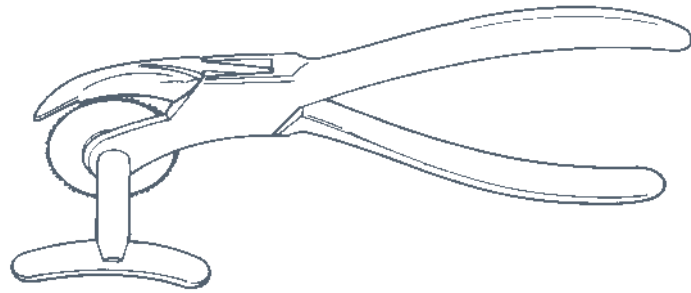

## SAWS

### Amputation

1791/05 200mm

1791/10 225mm

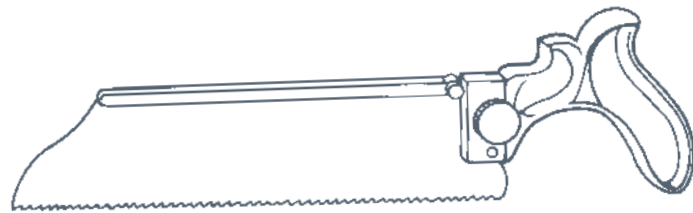

### Engels

1795/05 plaster saw

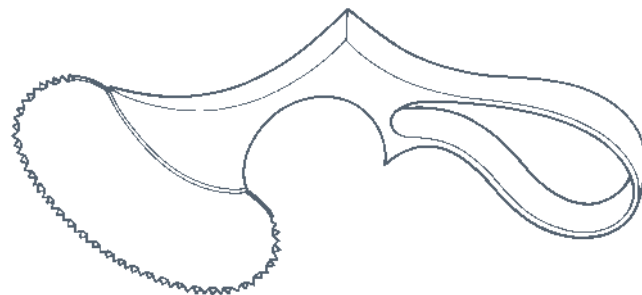



SCALPELS

GEN

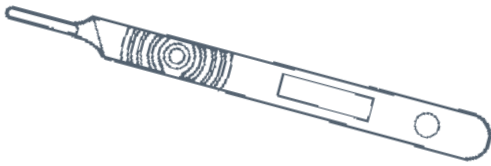

**Swann Morton**

handle  
1802/05 No. 3

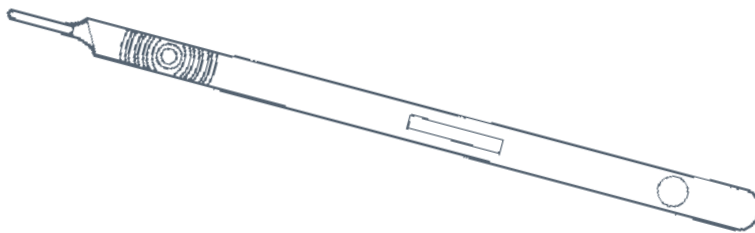

**Swann Morton**

handle  
1802/10 No. 3L

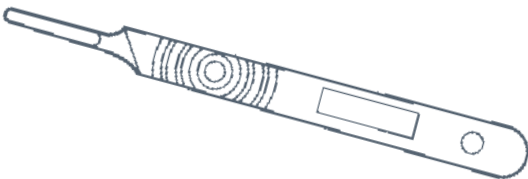

**Swann Morton**

handle  
1802/15 No. 4

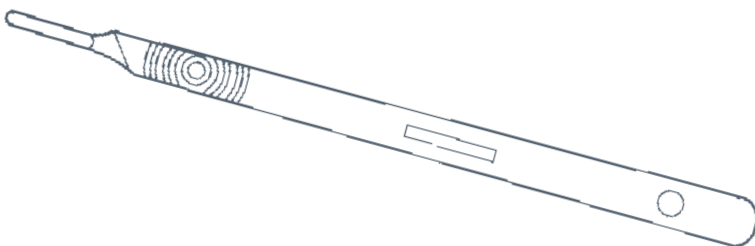

**Swann Morton**

handle  
1802/20 No. 4L

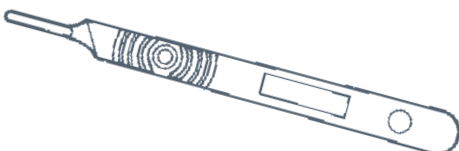

**Swann Morton**

handle  
1802/25 No. 5 (7)



## SCALPELS

### Swann Morton

1803/05-25 blades, **carbon, non-sterile** to fit handles Nos. 3, 3L and 5

1804/05-25 blades, **carbon, sterile** to fit handles Nos. 3, 3L and 5

1803/05 No. 10  
1804/05



1803/10 No. 10A  
1804/10



1803/15 No. 11  
1804/15



1803/20 No. 12  
1804/20



1803/25 No. 15  
1804/25



### Swann Morton

1803/30-70 blades, **carbon, non-sterile** to fit handles Nos. 4 and 4L

1804/30-70 blades, **carbon, sterile** to fit handles Nos. 4 and 4L

1803/30 No. 20  
1804/30



1803/35 No. 21  
1804/35



1803/40 No. 22  
1804/40



1803/45 No. 22A  
1804/45



1803/50 No. 23  
1804/50



1803/55 No. 24  
1804/55



1803/60 No. 25  
1804/60



1803/65 No. 26  
1804/65



1803/70 No. 27  
1804/70





SCISSORS

GEN

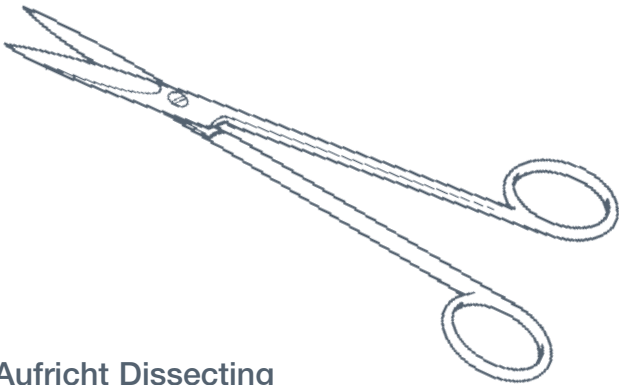

**Aufricht Dissecting**

straight, light pattern  
1820/05 150mm

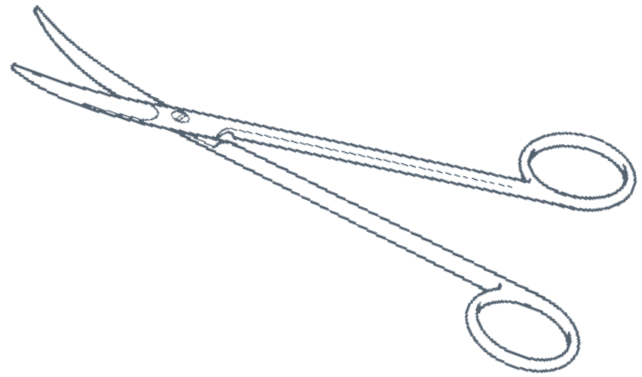

**Aufricht Dissecting**

curved, light pattern  
1821/05 150mm

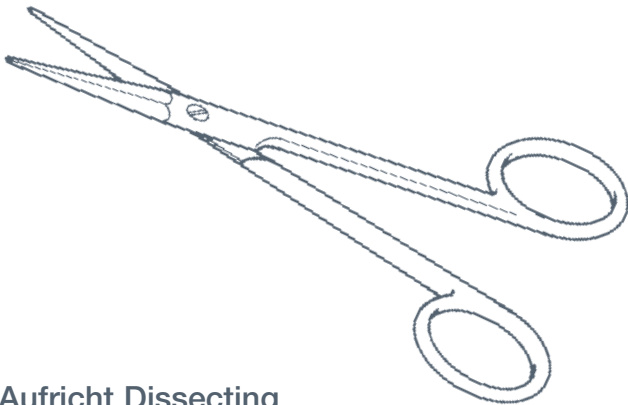

**Aufricht Dissecting**

straight, triangular blade  
1822/05 140mm

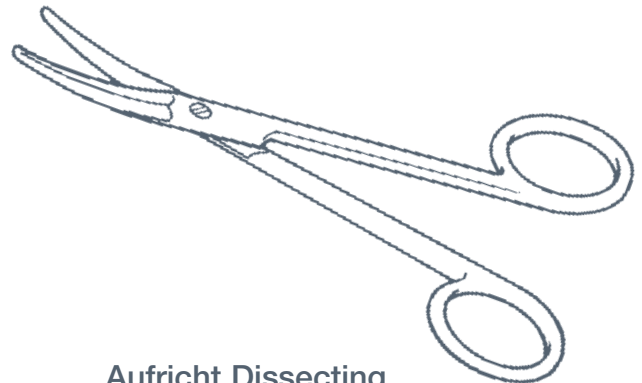

**Aufricht Dissecting**

curved, triangular blade  
1823/05 140mm

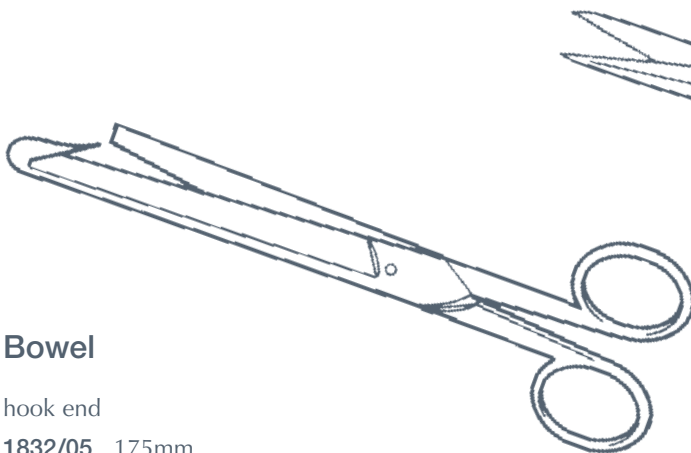

**Bowel**

hook end  
1832/05 175mm

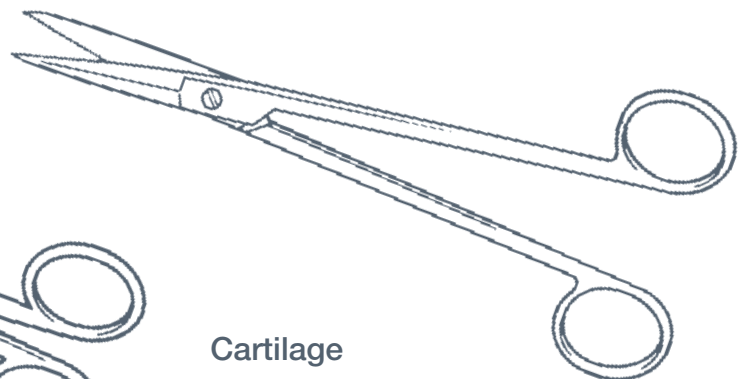

**Cartilage**

straight, fine points, serrated blades  
1837/05 180mm



SCISSORS

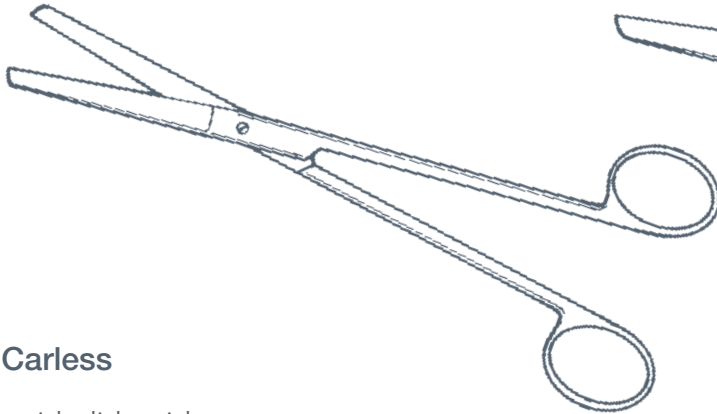

**Carless**

straight, lightweight,  
blunt point

1838/05 165mm

1838/10 200mm

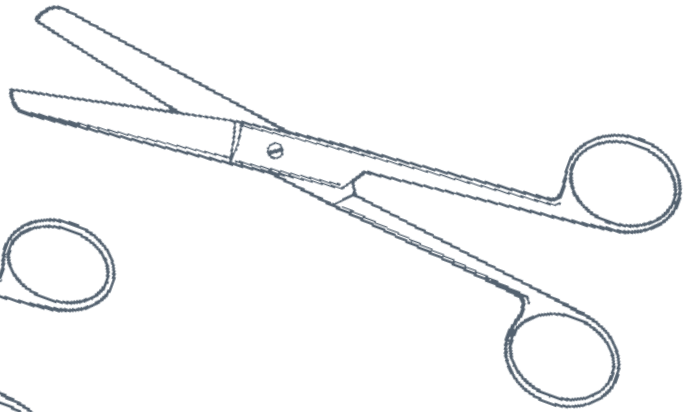

**Doyen**

straight, blunt point

1840/05 180mm

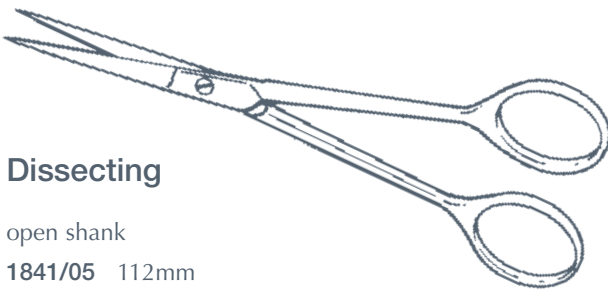

**Dissecting**

open shank

1841/05 112mm

1841/10 125mm

1841/15 150mm



**Dressing**

straight, blunt/blunt

1842/05 100mm

1842/10 125mm

1842/15 140mm

1842/20 150mm

1842/25 180mm

1842/30 200mm

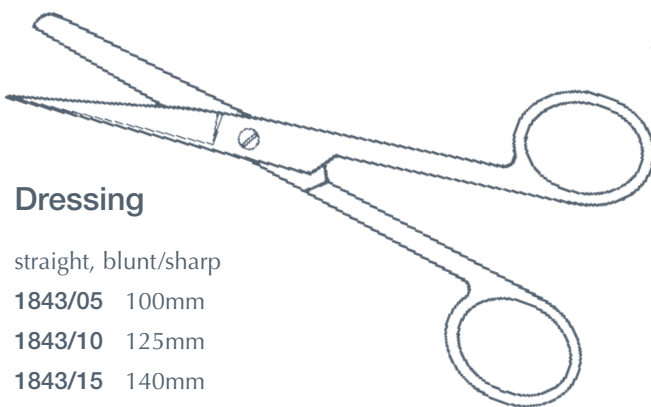

**Dressing**

straight, blunt/sharp

1843/05 100mm

1843/10 125mm

1843/15 140mm

1843/20 150mm

1843/25 180mm

1843/30 200mm



**Dressing**

straight, sharp/sharp

1844/05 100mm

1844/10 125mm

1844/15 140mm

1844/20 150mm

1844/25 180mm

1844/30 200mm





SCISSORS

GEN

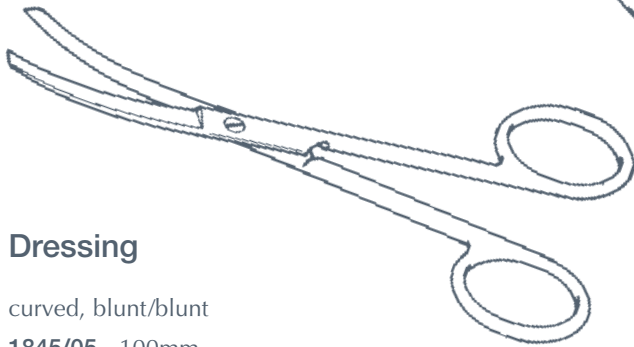

**Dressing**

- curved, blunt/blunt
- 1845/05 100mm
- 1845/10 125mm
- 1845/15 140mm
- 1845/20 150mm
- 1845/25 180mm
- 1845/30 200mm



**Dressing**

- curved, blunt/sharp
- 1846/05 100mm
- 1846/10 125mm
- 1846/15 140mm
- 1846/20 150mm
- 1846/25 180mm
- 1846/30 200mm

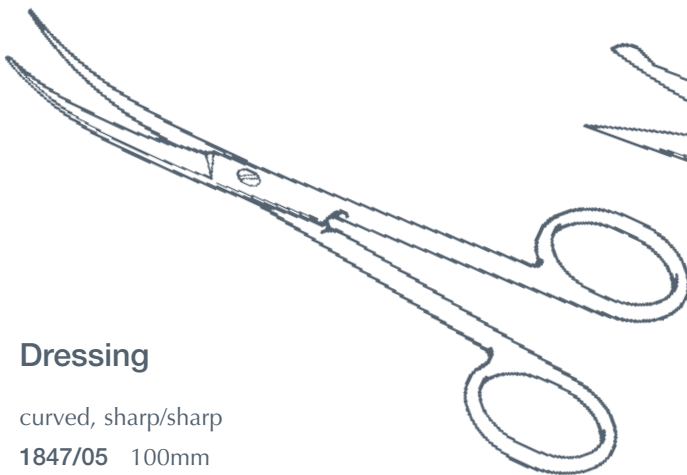

**Dressing**

- curved, sharp/sharp
- 1847/05 100mm
- 1847/10 125mm
- 1847/15 140mm
- 1847/20 150mm
- 1847/25 180mm
- 1847/30 200mm

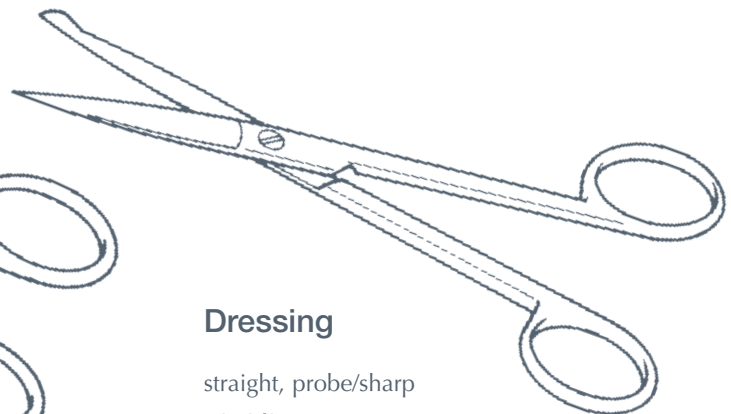

**Dressing**

- straight, probe/sharp
- 1848/05 125mm
- 1848/10 145mm

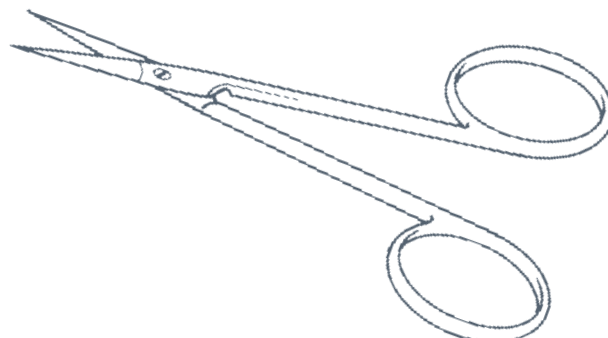

**Elliot Iris**

- sharp points
- 1850/05 85mm



## SCISSORS

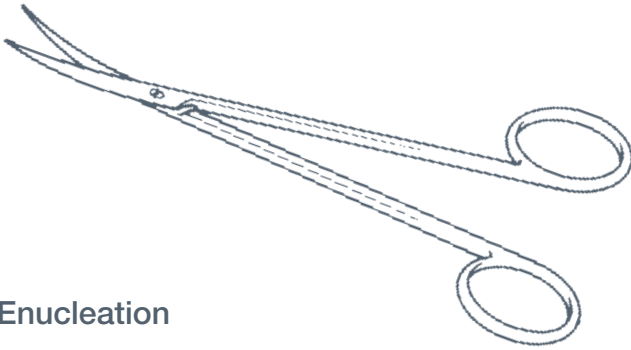

### Enucleation

curved on flat

1852/05 90mm

1852/10 115mm

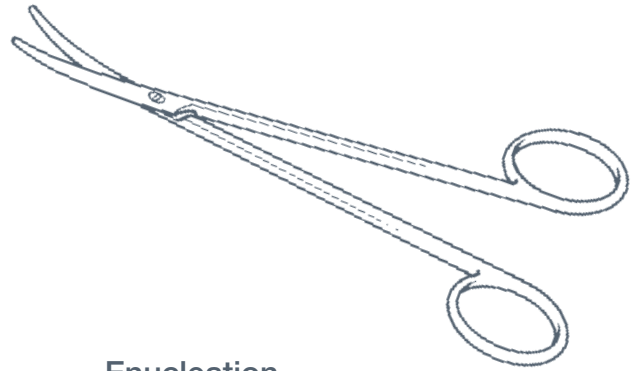

### Enucleation

curved on flat, extra strong

1853/05 115mm

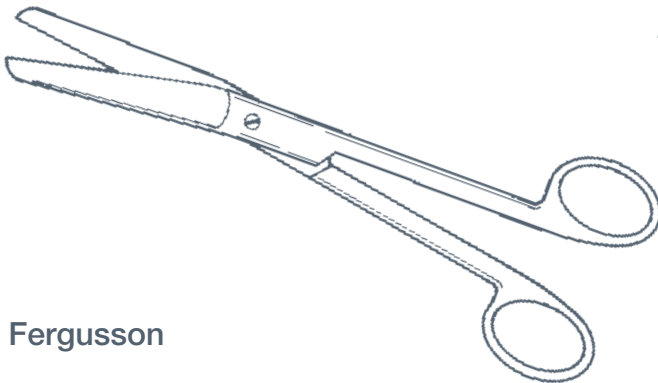

### Fergusson

angled on flat

1858/05 145mm

1858/10 150mm

1858/15 180mm



### Glasgow Iris

straight, fine sharp points

1859/05 100mm

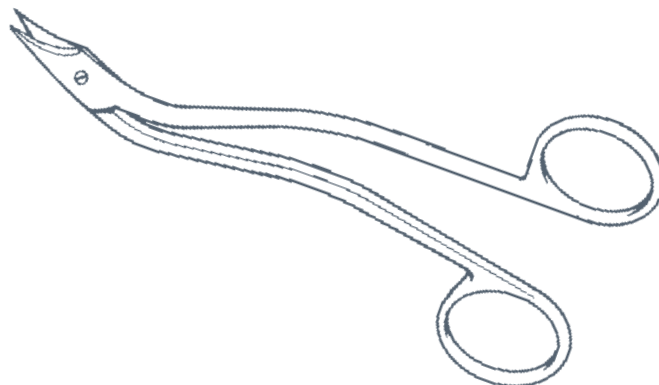

### Heaths Stitch

1864/05 150mm



SCISSORS

GEN

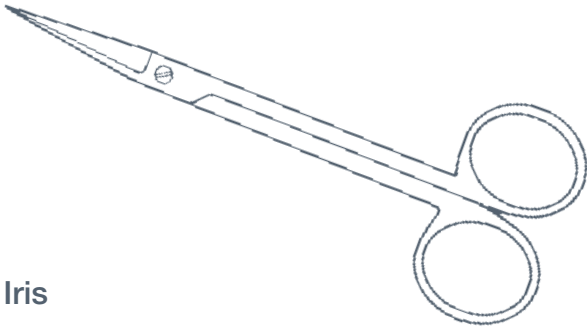

**Iris**

straight, sharp

**1866/05** 90mm

**1866/10** 110mm

straight, lightweight, sharp

**1866/25** 90mm

**1866/30** 110mm

straight, super lightweight, sharp

**1866/50** 110mm

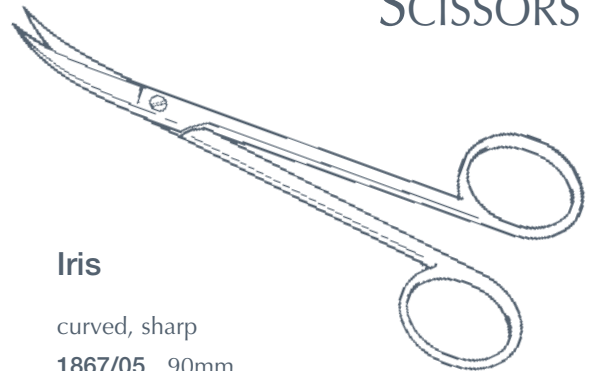

**Iris**

curved, sharp

**1867/05** 90mm

**1867/10** 110mm

curved, lightweight, sharp

**1867/25** 90mm

**1867/30** 110mm

curved, super lightweight, sharp

**1867/50** 110mm



**Lagrange Sclerotomy**

curved

**1868/05** 90mm

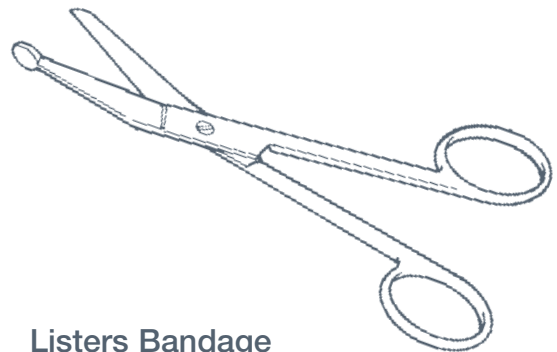

**Listers Bandage**

**1869/05** 140mm

**1869/10** 180mm

**1869/15** 200mm

**1869/20** 235mm



**Listers Bandage**

with double finger bow

**1870/05** 185mm

**1870/10** 210mm



**Listers, Eccentric**

**1871/05** 160mm

**1871/10** 190mm



SCISSORS

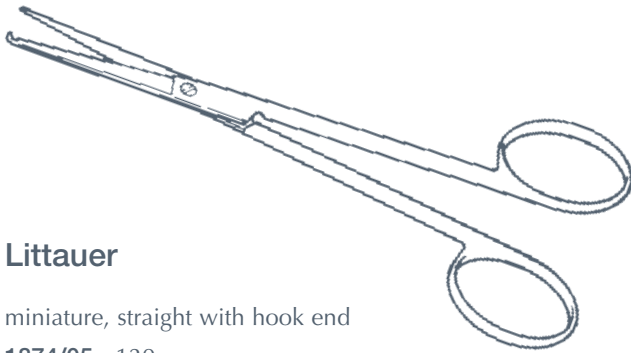

**Littauer**

miniature, straight with hook end  
1874/05 120mm

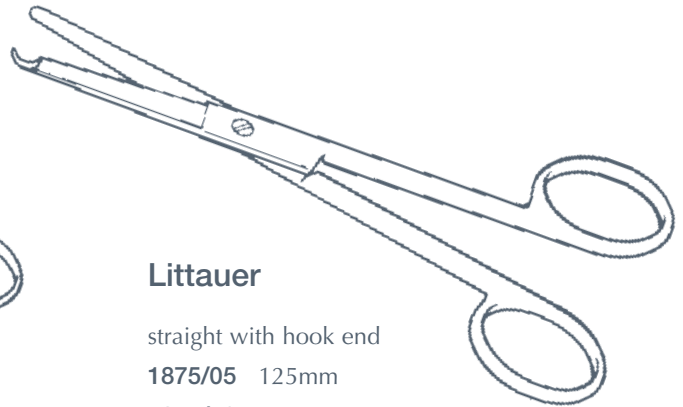

**Littauer**

straight with hook end  
1875/05 125mm  
1875/10 140mm  
1875/15 180mm

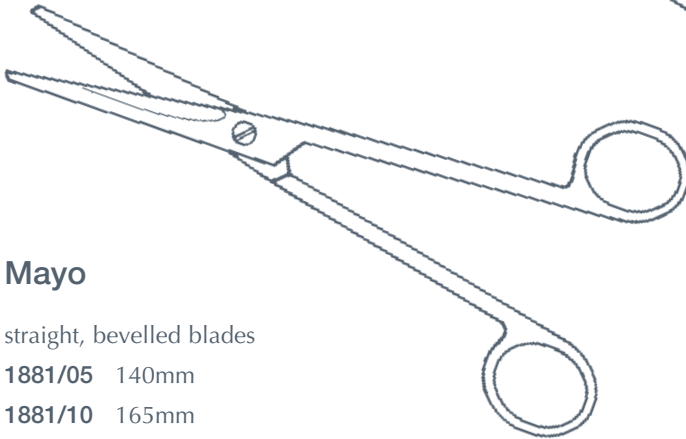

**Mayo**

straight, bevelled blades  
1881/05 140mm  
1881/10 165mm  
1881/15 190mm  
1881/20 215mm



**Mayo**

curved, bevelled blades  
1882/05 140mm  
1882/10 165mm  
1882/15 190mm  
1882/20 215mm

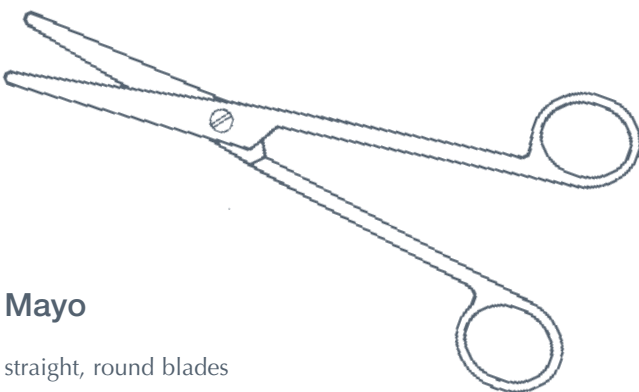

**Mayo**

straight, round blades  
1883/05 140mm  
1883/10 170mm

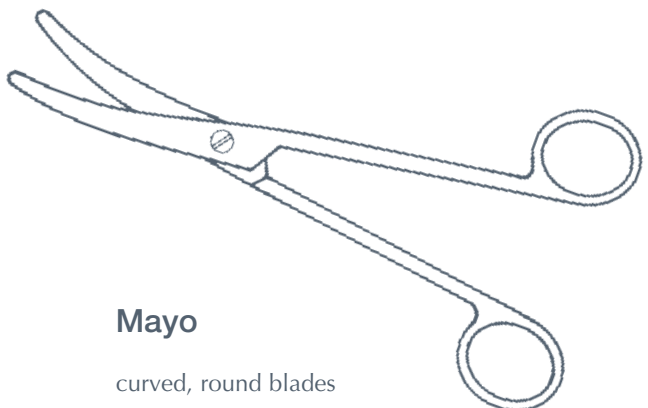

**Mayo**

curved, round blades  
1884/05 140mm  
1884/10 170mm



## SCISSORS

GEN

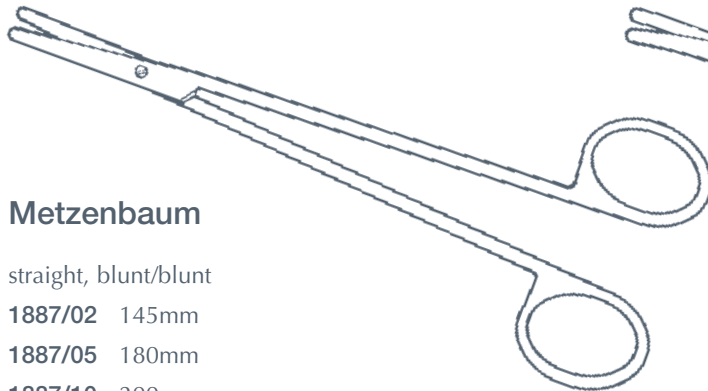
**Metzenbaum**

straight, blunt/blunt

1887/02 145mm

1887/05 180mm

1887/10 200mm

1887/15 230mm

1887/20 250mm

1887/25 280mm

1887/30 300mm

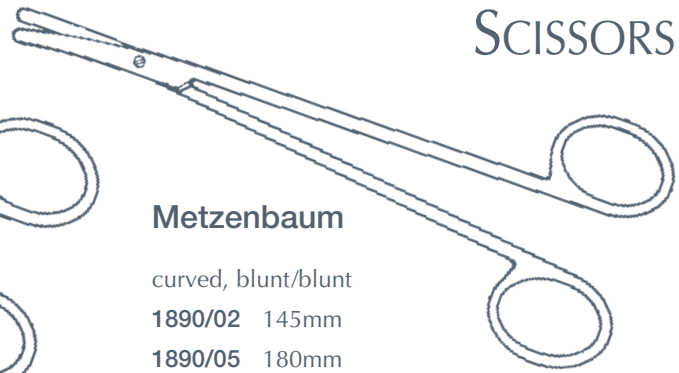
**Metzenbaum**

curved, blunt/blunt

1890/02 145mm

1890/05 180mm

1890/10 200mm

1890/15 230mm

1890/20 250mm

1890/25 280mm

1890/30 300mm

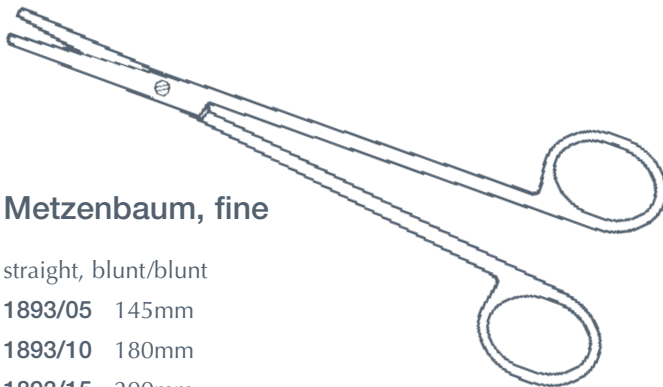
**Metzenbaum, fine**

straight, blunt/blunt

1893/05 145mm

1893/10 180mm

1893/15 200mm

1893/20 230mm

**Metzenbaum, fine**

straight, sharp/sharp

1894/05 145mm

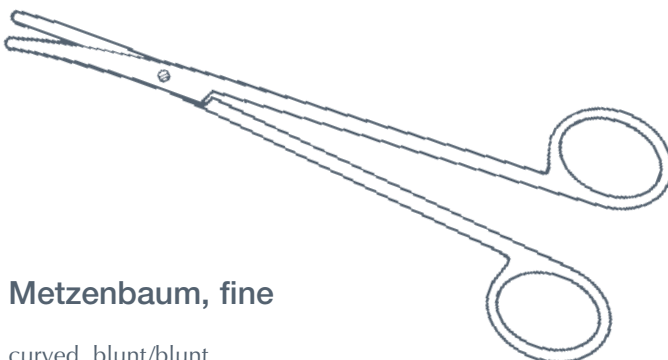
**Metzenbaum, fine**

curved, blunt/blunt

1895/05 145mm

1895/10 180mm

1895/15 200mm

1895/20 230mm

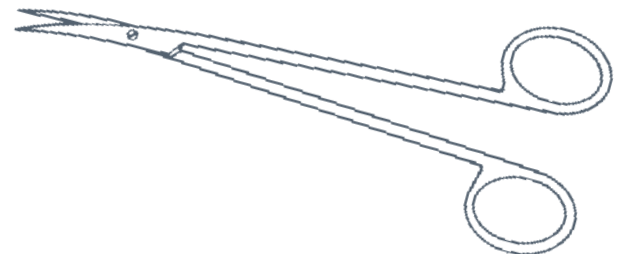
**Metzenbaum, fine**

curved, sharp/sharp

1896/05 145mm



GEN

# SCISSORS

## Nelson Lobectomy

straight  
1898/05 230mm

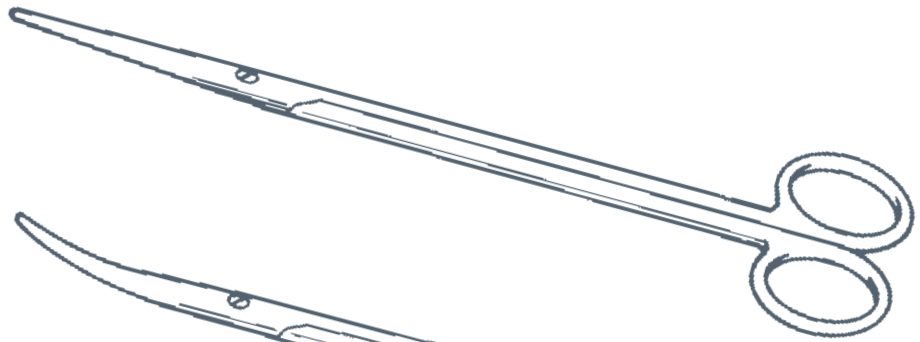

## Nelson Lobectomy

curved  
1899/05 230mm

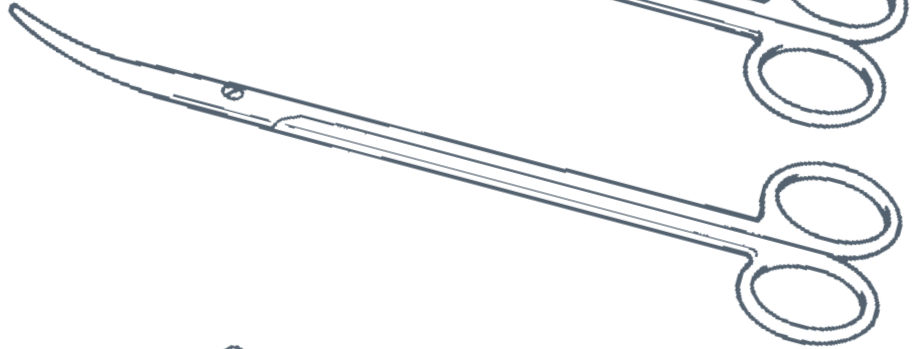

## Paynes Suture

1900/01 100mm

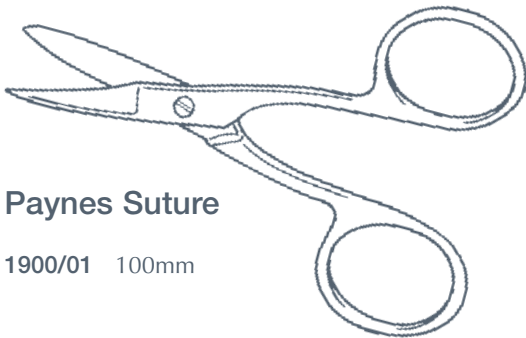

## Post Mortem

ball end, open shank  
1900/05 140mm



## Post Mortem

probe/sharp, open shank  
1904/05 100mm

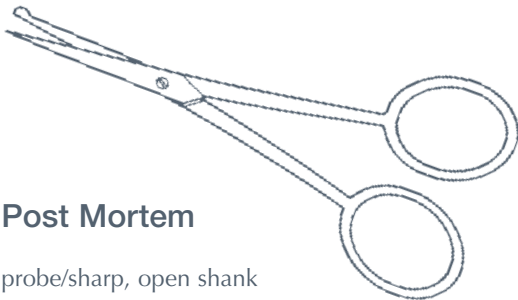

## Stevens

straight, sharp  
1910/05 115mm



## Stevens

curved, sharp  
1910/25 115mm



## Stevens

straight, blunt  
1910/45 115mm





## SCISSORS

GEN

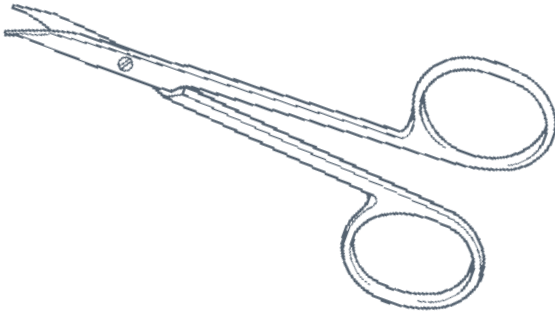
**Stevens**

curved, blunt

1910/65 115mm

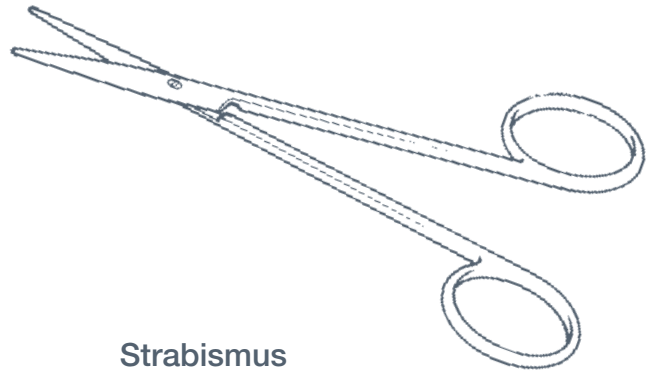
**Strabismus**

straight

1912/05 90mm

1912/10 110mm

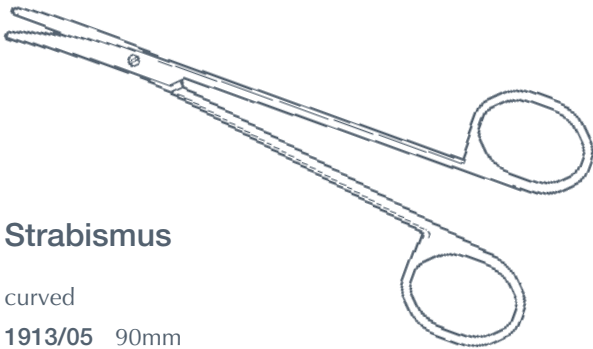
**Strabismus**

curved

1913/05 90mm

1913/10 110mm

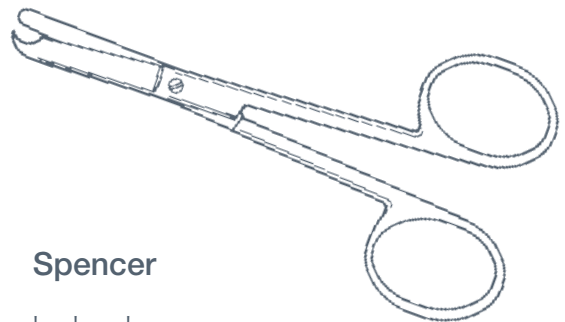
**Spencer**

hook end

1914/05 105mm

**Universal Bandage**

saw edge, autoclavable handles

1917/05 175mm

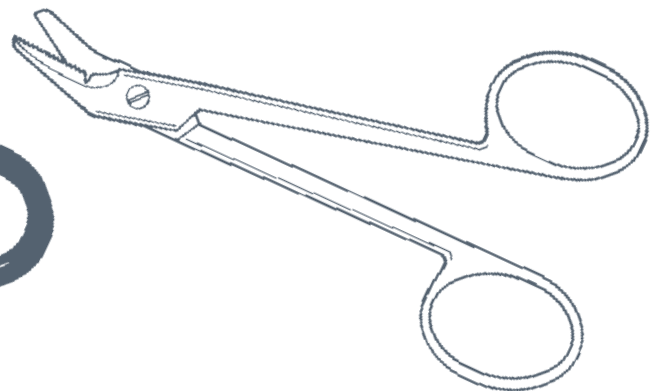
**Universal Wire Cutting**

saw edge

1920/05 120mm



# HARD EDGE SCISSORS

The Hard Edge scissors shown on pages 50-52 are made from a special alloy which guarantees long life however frequently the scissors are used, together with a smooth accurate and consistent cutting action.

The extreme hardness results in less frequent sharpening and so minimises the time "out of service" from the operating theatre. (Should the scissors ever need sharpening it is recommended that they are only re-sharpened by the manufacturers who are familiar with the specialist techniques involved in the design.)

Gold plated finger rings allow clear and positive identification.

S Murray's Hard Edge instruments all carry a minimum guarantee period of 3 years, subject to proper usage.

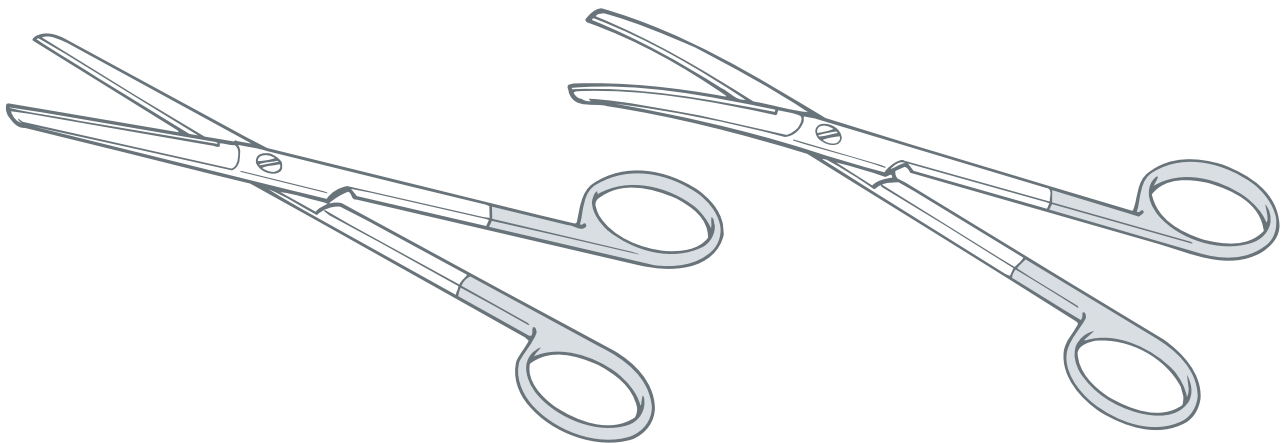

### Dressing

straight, blunt/blunt  
1923/05 145mm

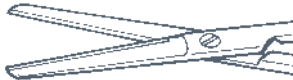

straight, blunt/sharp  
1924/05 145mm

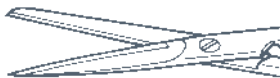

straight, sharp/sharp  
1925/05 145mm



### Dressing

curved, blunt/blunt  
1926/05 145mm



curved, blunt/sharp  
1927/05 145mm

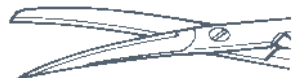

curved, sharp/sharp  
1928/05 145mm

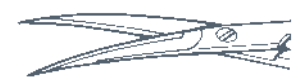





HARD EDGE SCISSORS

GEN

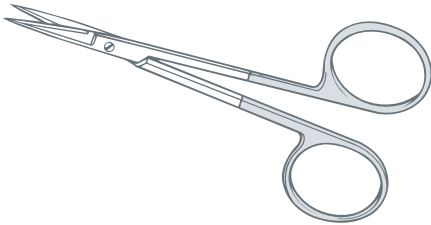

**Iris**

straight, sharp

**1929/05** 115mm



curved, sharp

**1930/05** 115mm

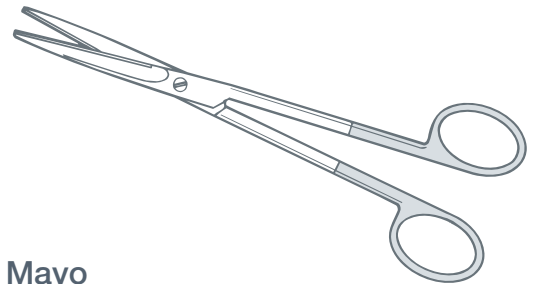

**Mayo**

straight, flat blades

**1931/05** 145mm

**1931/10** 170mm

**1931/15** 190mm



curved, flat blades

**1932/05** 145mm

**1932/10** 170mm

**1932/15** 190mm

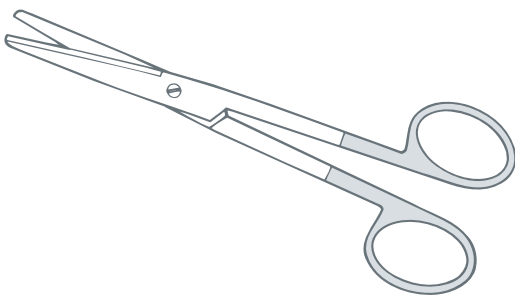

**Mayo-Stille**

straight, round blades

**1934/05** 150mm

**1934/10** 170mm



curved, round blades

**1935/05** 150mm

**1935/10** 170mm

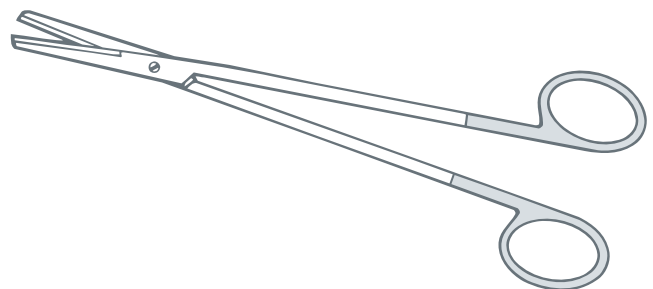

**Metzenbaum**

straight, blunt/blunt

**1938/05** 145mm

**1938/10** 180mm

**1938/15** 200mm

**1938/20** 230mm



# HARD EDGE SCISSORS

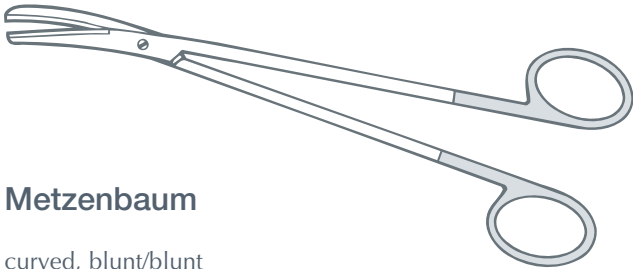

## Metzenbaum

curved, blunt/blunt

1939/05 145mm

1939/10 180mm

1939/15 200mm

1939/20 230mm

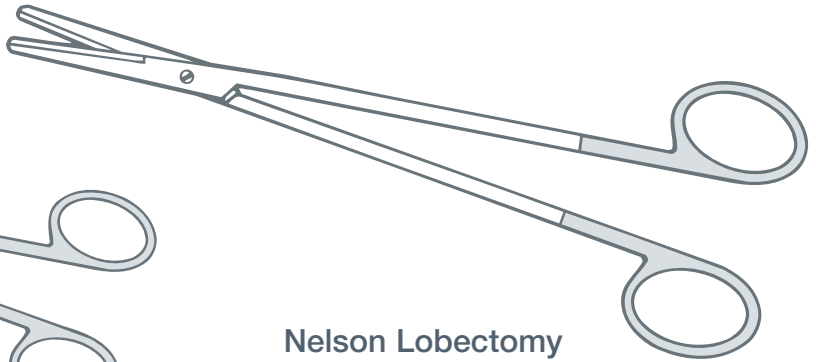

## Nelson Lobectomy

straight

1945/05 230mm

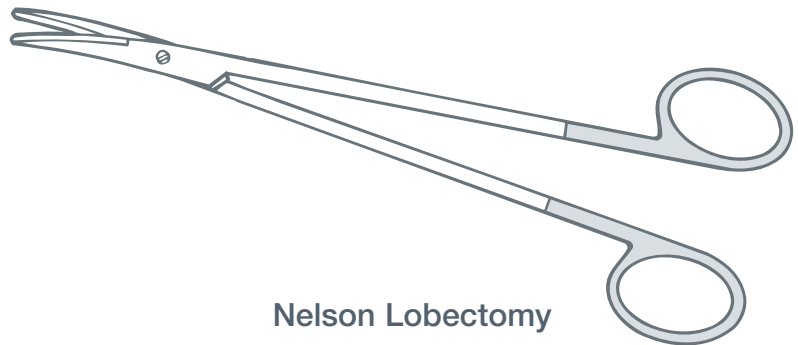

## Nelson Lobectomy

curved

1946/05 230mm



## Universal Wire Cutting

1947/05 120mm

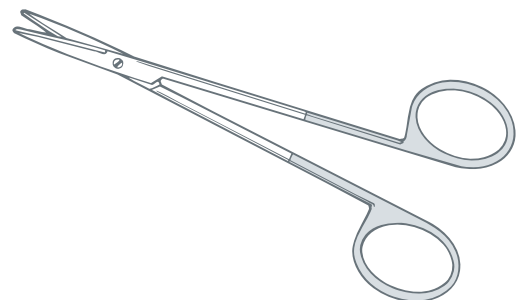

## Strabismus

straight

1948/05 110mm

curved

1949/05 110mm





## SCISSORS, ULTRA-CUTTING

The Ultracut Scissors shown on pages 53 and 54 are designed to give an effortless cutting action through the full length of the blade.

The bottom blades are ground to a razor edge suitable for all materials from fine tissue to coarse bandages.

The serrated top blades prevent tissue slippage ensuring minimal damage.

A durable black coating on the handles allows easy recognition.

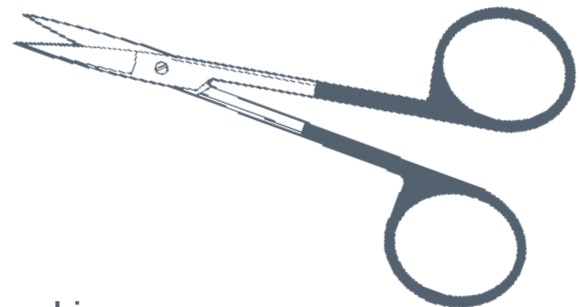
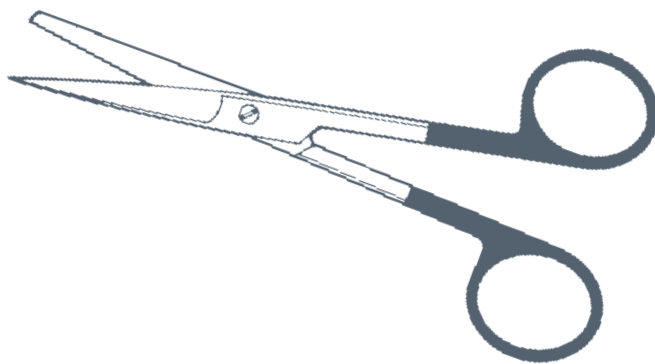

### Dressing

straight, blunt/sharp  
1950/05 145mm



curved, blunt/sharp  
1951/05 145mm



### Iris

straight  
1955/05 115mm



curved  
1956/05 115mm

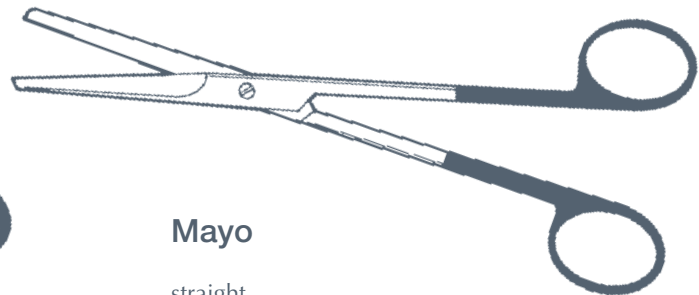
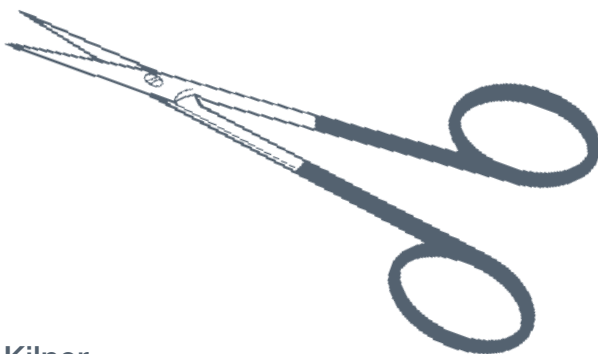

### Kilner

straight, sharp  
1957/05 110mm



curved, blunt  
1958/05 110mm

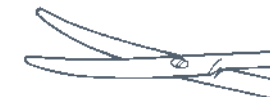

### Mayo

straight  
1965/05 145mm  
1965/10 170mm  
1965/12 200mm  
1965/15 215mm



curved  
1966/05 145mm  
1966/10 170mm  
1966/12 200mm  
1966/15 215mm

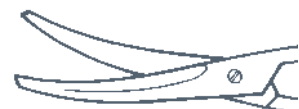



SCISSORS, ULTRA-CUTTING

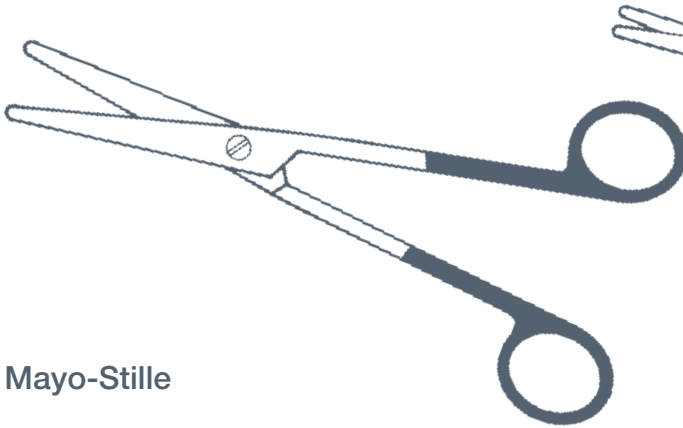

Mayo-Stille

straight, round blades

1967/05 150mm

1967/10 170mm

1967/15 190mm

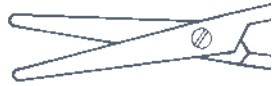

curved, round blades

1968/05 150mm

1968/10 170mm

1968/15 190mm

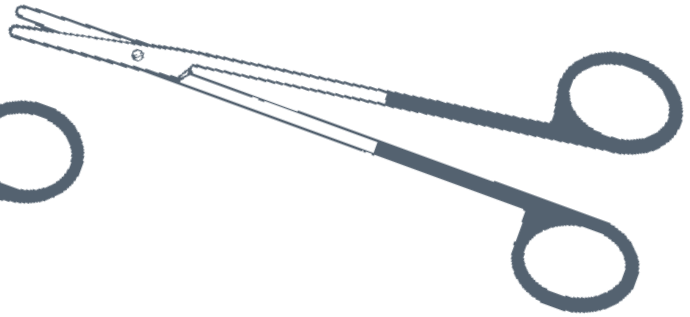

Metzenbaum

straight

1970/05 145mm

curved

1971/05 145mm

1971/10 180mm

1971/15 200mm

1971/20 230mm

1971/25 260mm

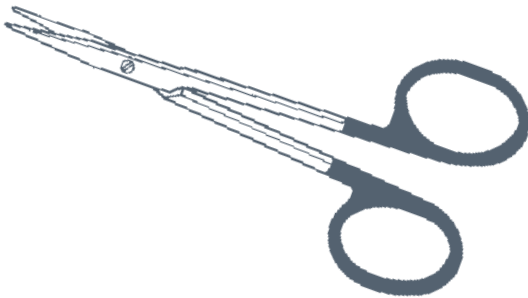

Stevens

straight, blunt

1972/25 110mm

curved, blunt

1972/50 110mm

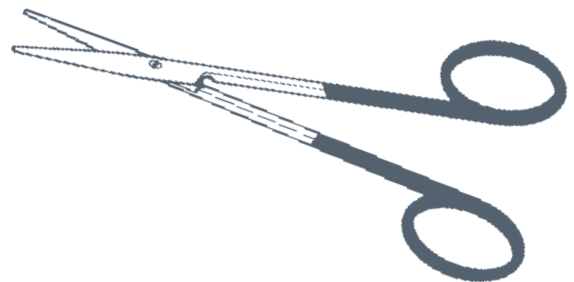

Strabismus

straight

1973/05 110mm

curved

1974/05 110mm





## SINUS FORCEPS

GEN

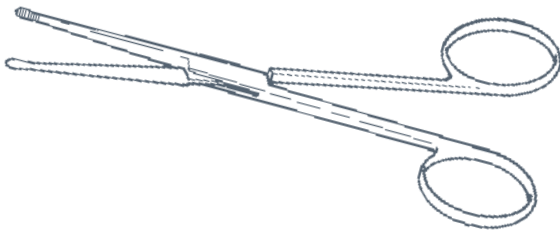
**Lister**

serrated tip

1999/05 125mm

1999/10 150mm

1999/15 180mm

1999/20 200mm

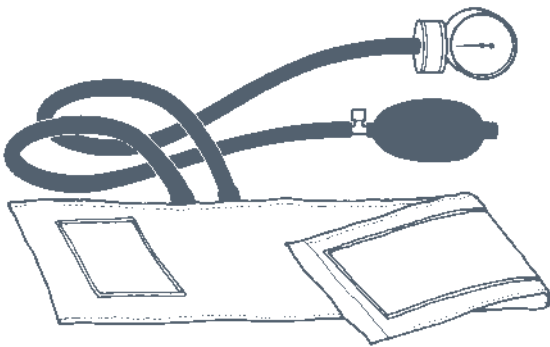
**Aneroid**

with velcro cuff in black zip-up case, made in Taiwan

2060/01 complete

2060/21 spare cuff, velcro

2060/23 spare bladder

2060/25 spare bulb

2060/26 spare control valve

2060/27 spare end valve

2060/30 spare gauge

2060/31 spare case

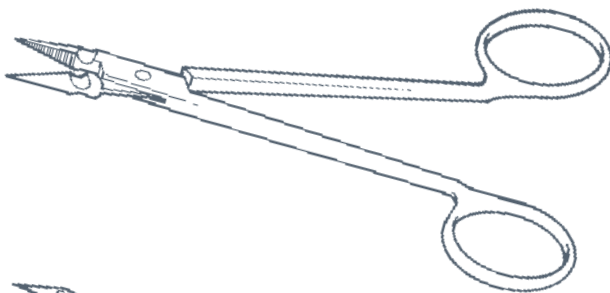
**Arthur**

pointed serrated jaws

2062/05 125mm

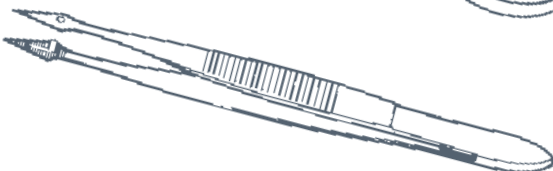
**Hunter**

straight

2065/05 105mm

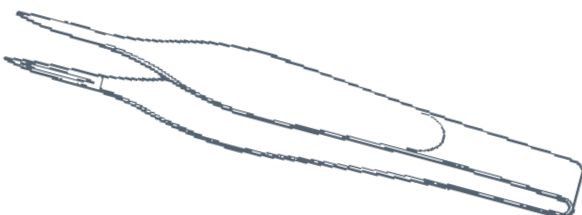
**Martin**

2066/05 75mm

2066/10 90mm

2066/15 115mm



# SPONGE HOLDING FORCEPS

## Foerster

straight, serrated jaws  
2068/05 180mm  
2068/10 240mm

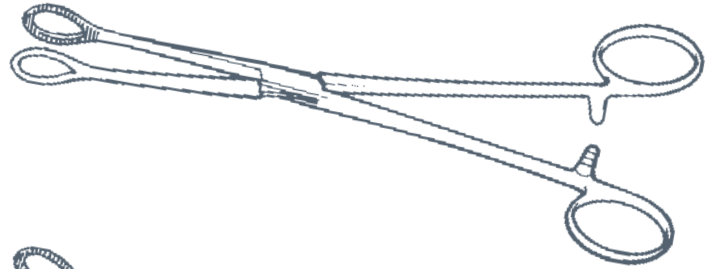

## Foerster

curved, serrated jaws  
2069/05 180mm  
2069/10 240mm

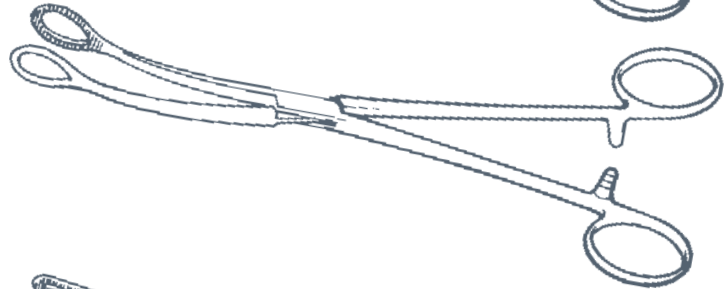

## Rampléy

straight, serrated jaws  
2071/05 180mm  
2071/10 240mm

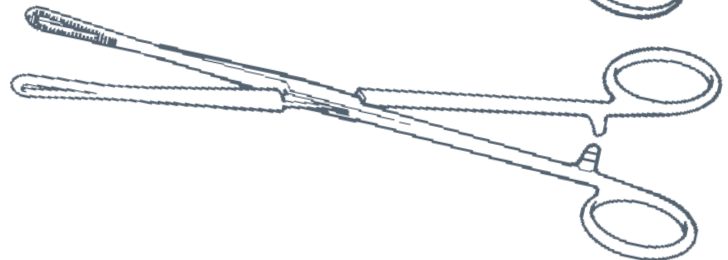

# STERILISER FORCEPS

## Cheatle

light, box joint  
2073/50 265mm

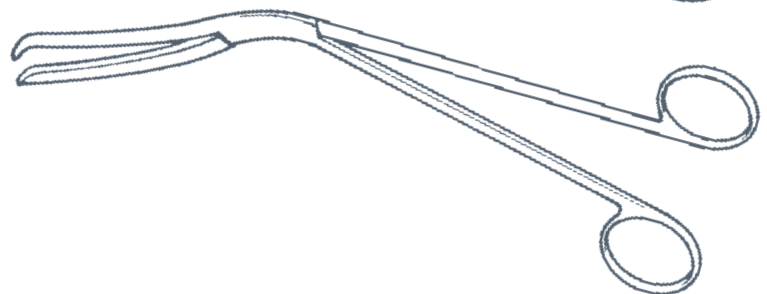

# STETHOSCOPES

## Nurse

single head, made in Taiwan  
2080/01 complete



## Popular

dual head, made in Taiwan  
2081/01 complete



## Spare Parts

2089/21 tubing, various colours  
2089/22 headframe, binaural  
2089/23 ear nibs, pair

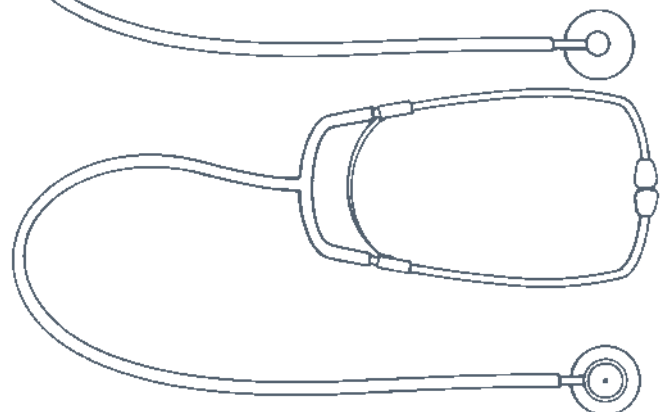
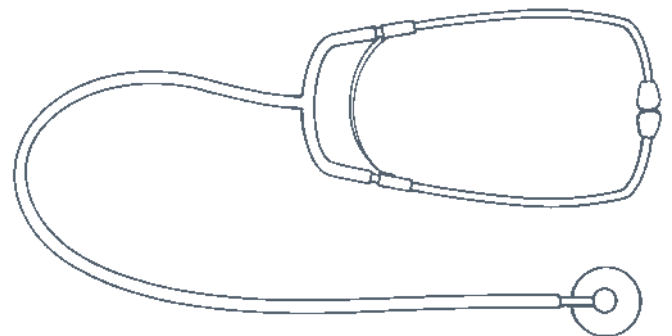



## SUCTION TUBES

GEN

**American Pattern**

with stilette

2093/05 chrome plated

**Poole**

chrome plated, curved

2110/05 240mm

chrome plated, straight

2110/10 240mm



Lawrie Extension

2111/05 175mm

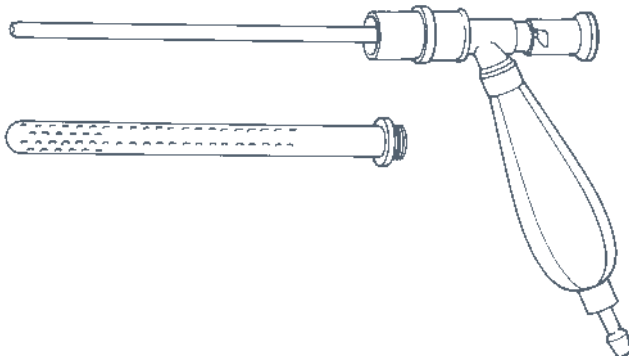
**Tinckler (Simpson Smith)**with on/off valve, removeable perforated  
outer sheath and handle

2115/05 150mm x 255mm

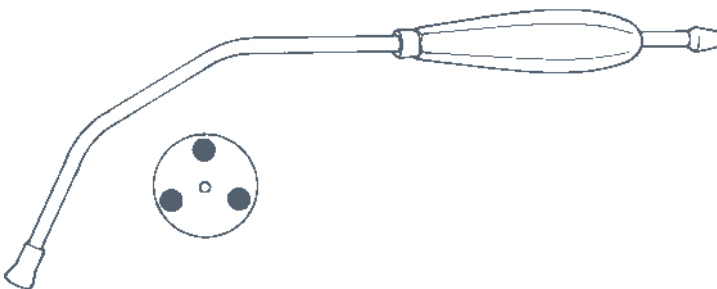
**Yankauer**

chrome plated

2125/05 305mm

2125/20 spare rose

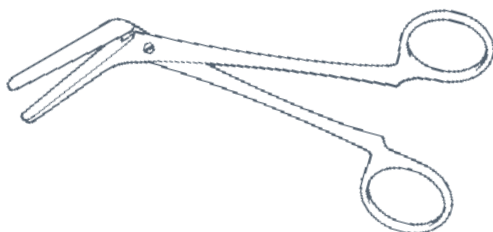

## SUTURE FORCEPS

**Guy's**

angled flat blades, screw joint

2130/05 150mm



# TISSUE FORCEPS

## Allis

- 150mm
- 2135/02 2/3 teeth
- 2135/05 3/4 teeth
- 2135/10 4/5 teeth
- 2135/15 5/6 teeth
- 2135/20 6/7 teeth

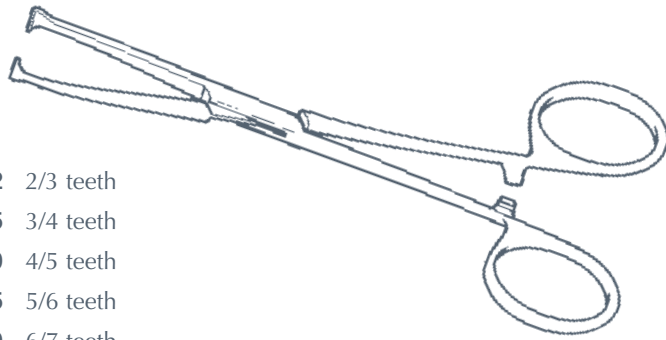

## Allis (American Pattern)

- 160mm
- 2140/05 3/4 teeth

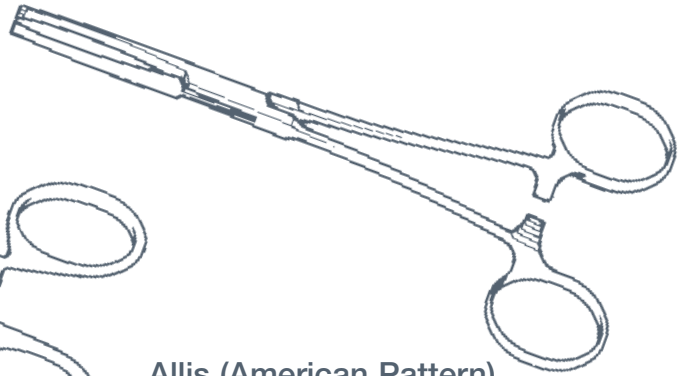

## Babcock

- serrated jaws
- 2145/05 165mm
- 2145/10 200mm
- 2145/15 230mm

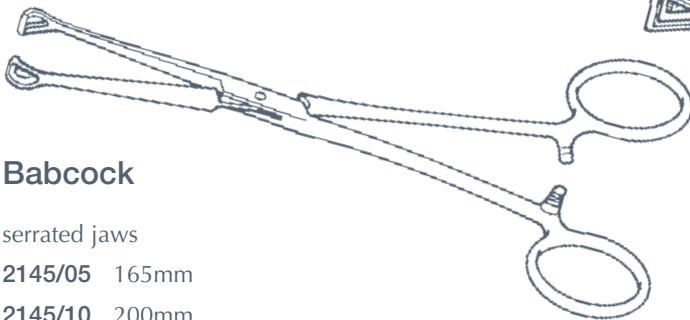

## Duval

- serrated
- 2165/05 190mm, 13mm jaws

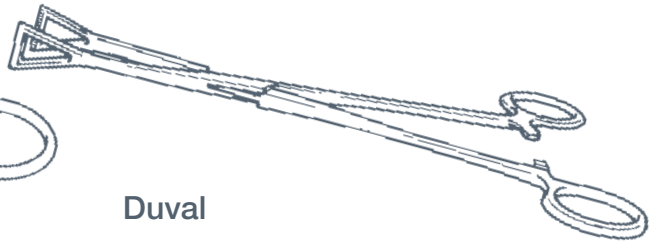

## Judd-Allis

- 195mm
- 2175/05 3/4 teeth

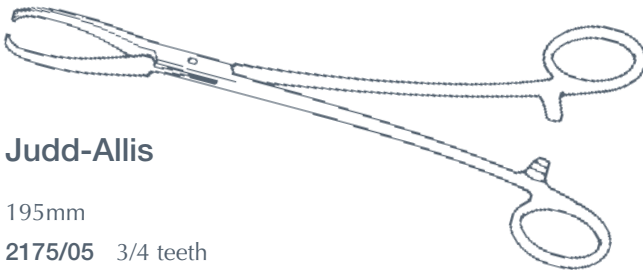

## Lanes

- 1/2 teeth fenestrated
- 2180/05 125mm
- 2180/10 150mm
- 2180/15 195mm

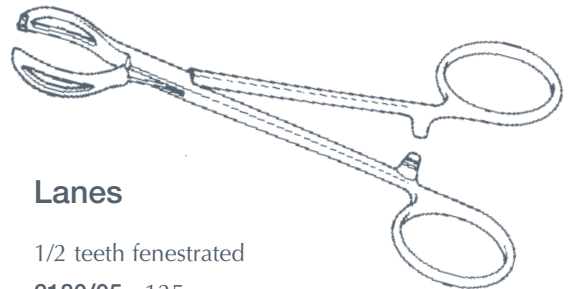

## Littlewood

- 2/3 teeth
- 2185/05 190mm

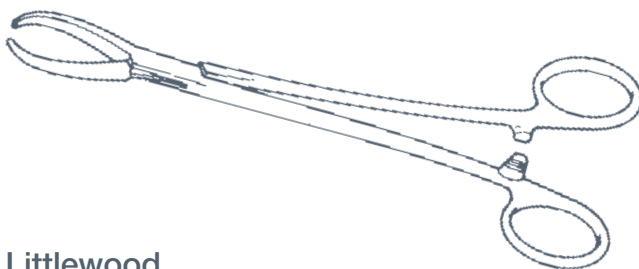

## Poirier

- 2/3 teeth, screw joint
- 2189/05 125mm

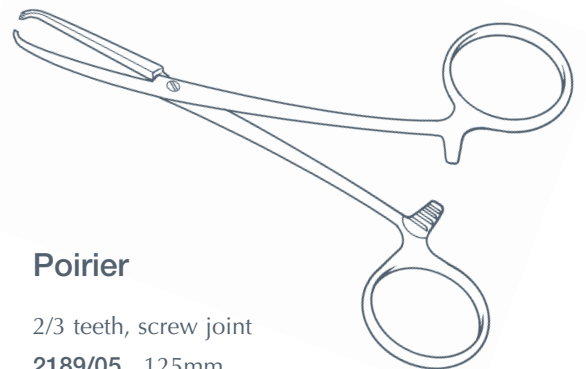





TISSUE FORCEPS

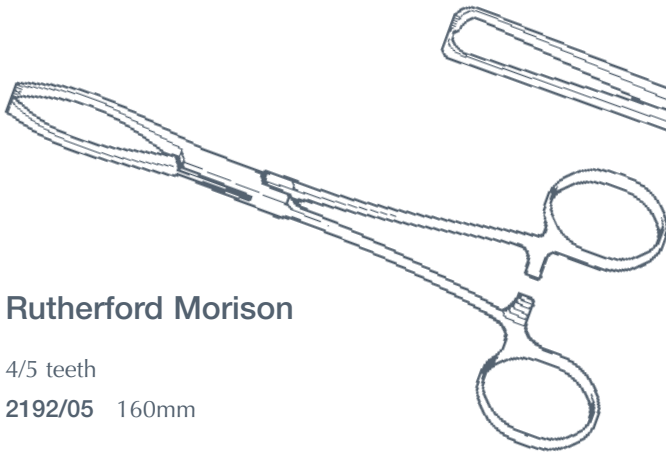

**Rutherford Morison**

4/5 teeth  
2192/05 160mm



**Stiles**

6/7 teeth  
2193/05 205mm

TONGUE FORCEPS

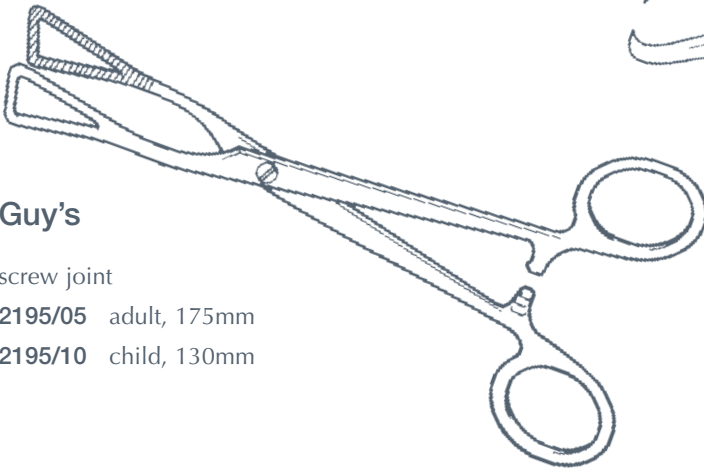

**Guy's**

screw joint  
2195/05 adult, 175mm  
2195/10 child, 130mm

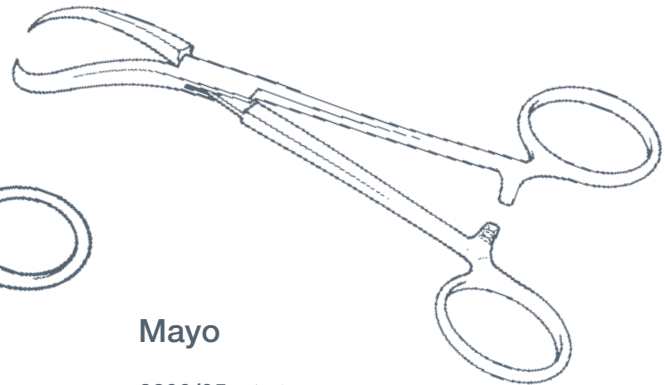

**Mayo**

2200/05 140mm

TOWEL CLIPS

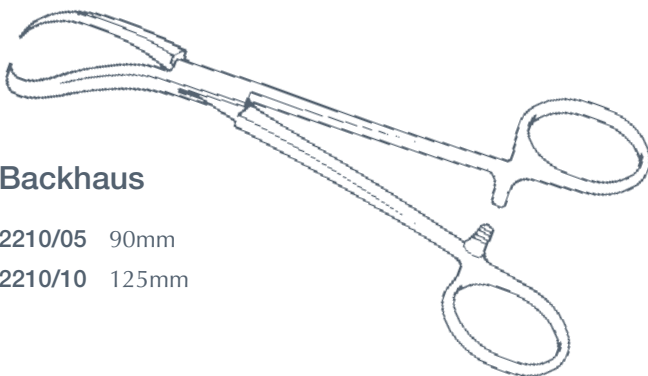

**Backhaus**

2210/05 90mm  
2210/10 125mm

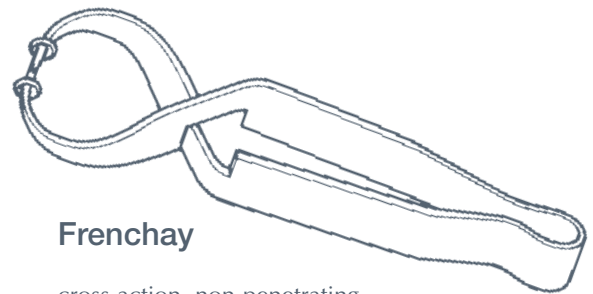

**Frenchay**

cross action, non-penetrating  
2220/05 90mm

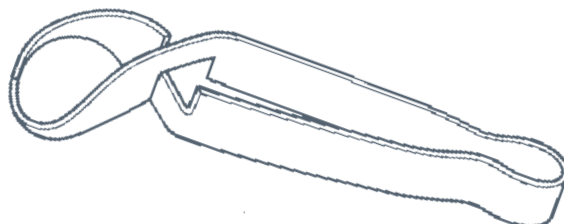

**Shardle**

cross action  
2230/05 90mm



GEN

## TUBING CLAMPS

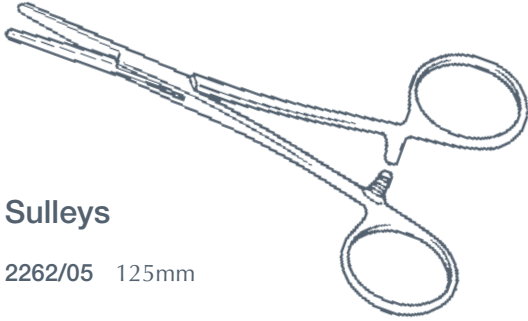

**Sulleys**

2262/05 125mm

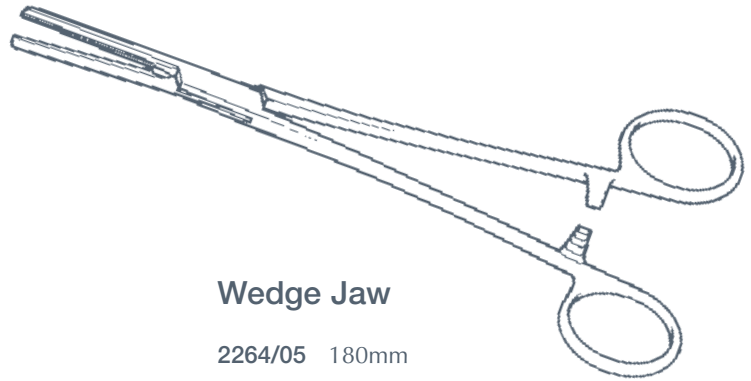

**Wedge Jaw**

2264/05 180mm

2264/10 200mm

## VASECTOMY CLAMPS

### Ring Type

140mm

2265/03 3.0mm

2265/05 3.5mm

2265/10 4.0mm

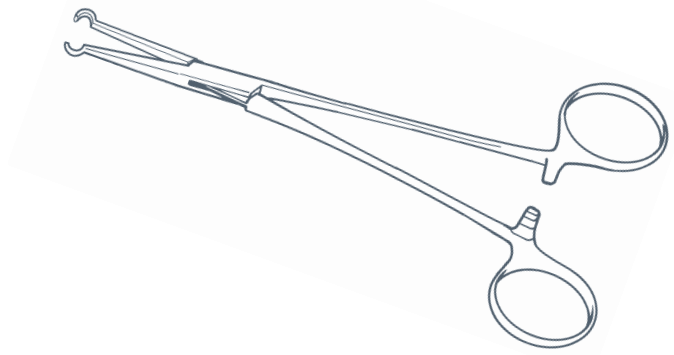

## VASECTOMY FORCEPS

### Curved, Sharp

2267/05 140mm

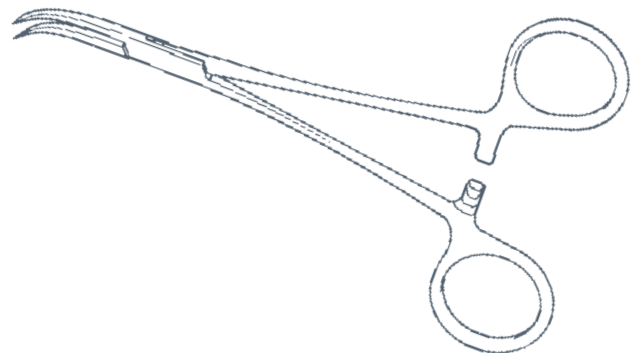



## HOLLOWWARE

GEN

## Forceps Jar

stainless steel, diameter x height:

2270/05	50mm x 100mm
2270/10	75mm x 175mm
2270/15	100mm x 200mm

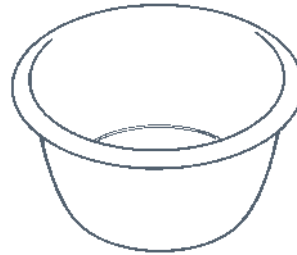
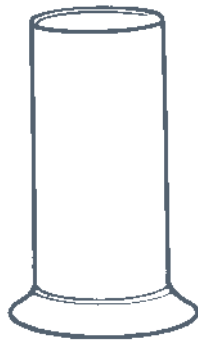

## Gallipot

stainless steel, capacity, diameter x depth:

2273/05	57ml,	64mm x 35mm
2273/10	113ml,	76mm x 44mm
2273/15	170ml,	82mm x 49mm
2273/20	255ml,	95mm x 57mm

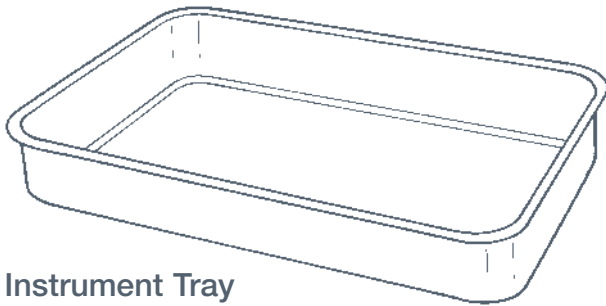

## Instrument Tray

stainless steel, length x width x depth:

2275/05	220mm x 170mm x 50mm
2275/10	275mm x 220mm x 50mm
2275/15	325mm x 250mm x 50mm
2275/20	325mm x 275mm x 50mm
2275/25	375mm x 275mm x 50mm
2275/30	375mm x 325mm x 50mm

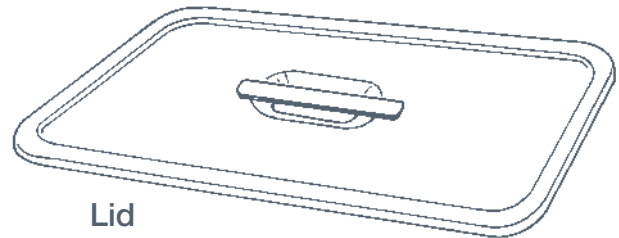

## Lid

for use with instrument trays

stainless steel, length x width:

2275/06	220mm x 170mm
2275/11	275mm x 220mm
2275/16	325mm x 250mm
2275/21	325mm x 275mm
2275/26	375mm x 275mm
2275/31	375mm x 325mm

## Jug, Graduated

stainless steel, capacity, diameter x height:

2278/05	250ml,	83mm x 97mm
2278/10	500ml,	95mm x 115mm
2278/15	1000ml,	127mm x 136mm

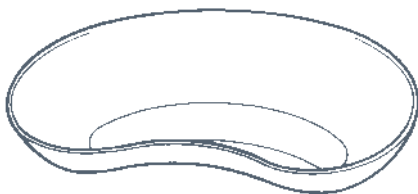

## Kidney Dish

stainless steel, length x width x depth:

2281/05	152mm x 76mm x 30mm
2281/10	203mm x 102mm x 41mm
2281/15	255mm x 127mm x 51mm
2281/20	305mm x 150mm x 60mm

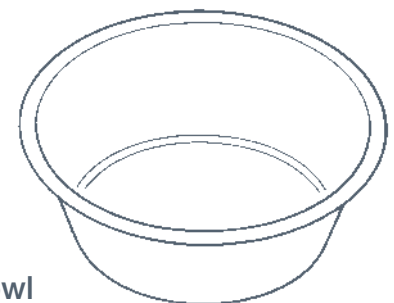

## Lotion Bowl

stainless steel, capacity, diameter x depth:

2285/05	250ml,	100mm x 45mm
2285/10	500ml,	125mm x 55mm
2285/15	900ml,	150mm x 65mm
2285/20	2000ml,	205mm x 90mm
2285/25	4000ml,	255mm x 110mm
2285/30	7000ml,	350mm x 135mm



THO

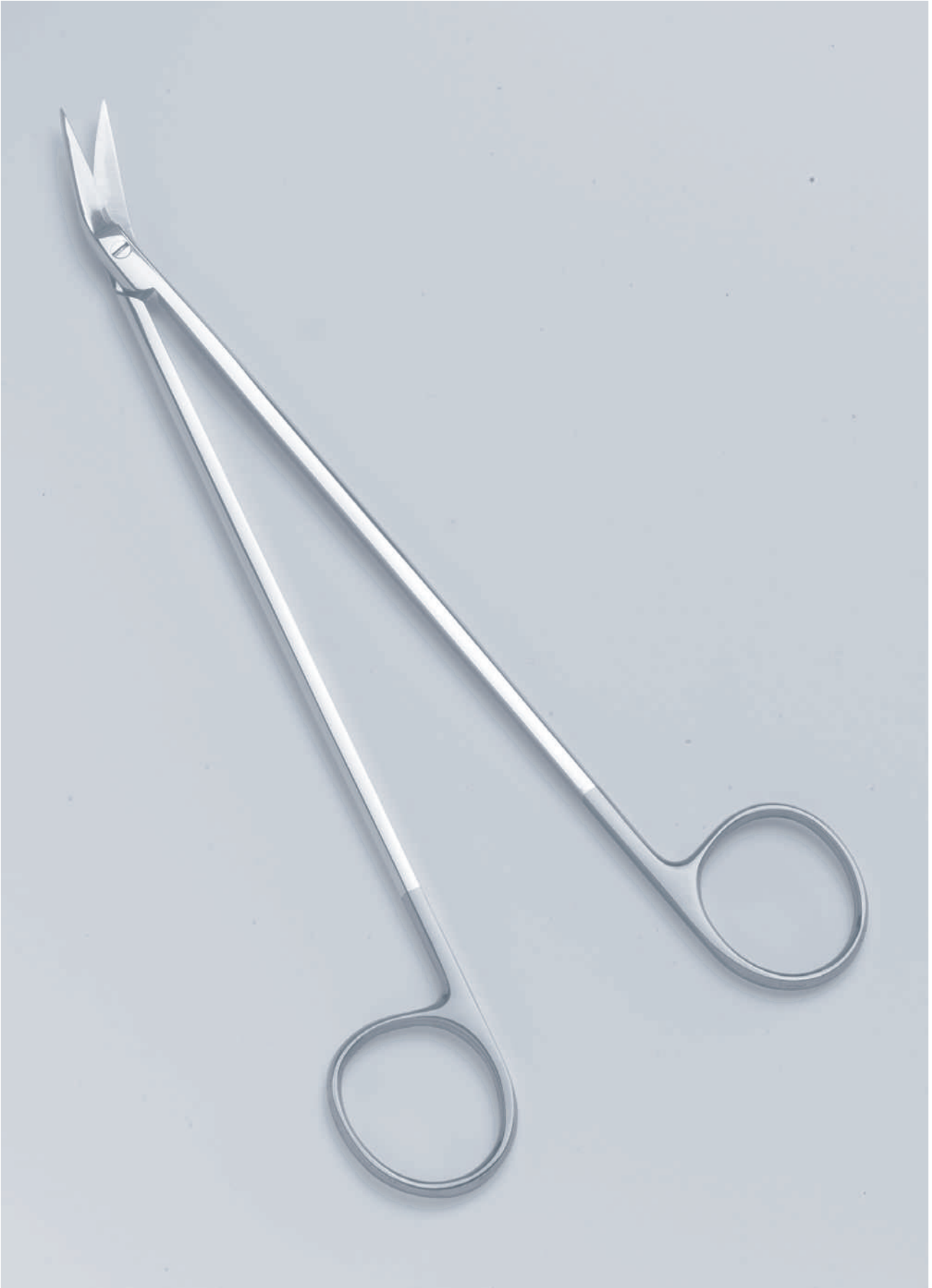

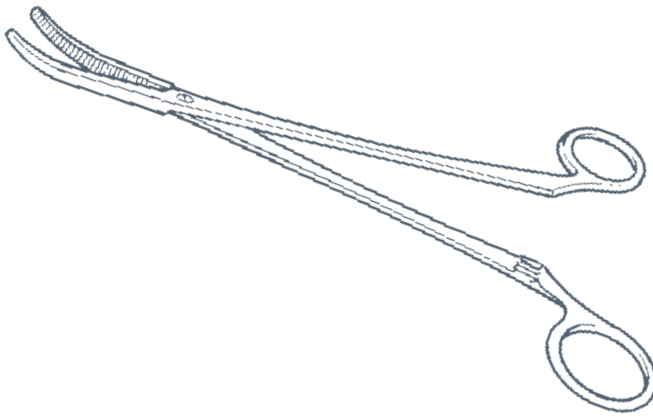

## ARTERY FORCEPS

**Roberts**

curved on flat, box joint

2525/05 230mm

curved on flat, screw joint

2526/05 230mm

## BIOPSY PUNCH

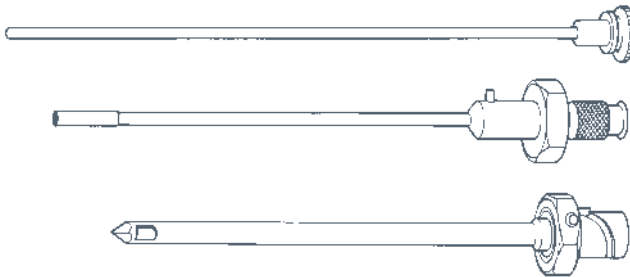
**Abrams Pleural**

outer needle with trocar point, inner needle and stilllette. Length 125mm.

2535/05 4mm

## CLAMPS

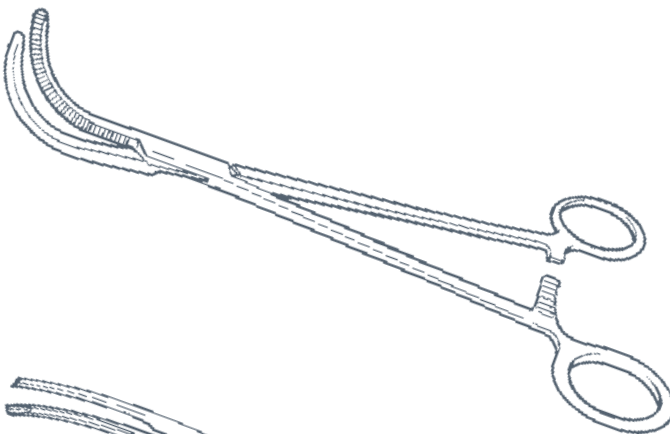
**Crafoord**

medium curve

2555/50 240mm

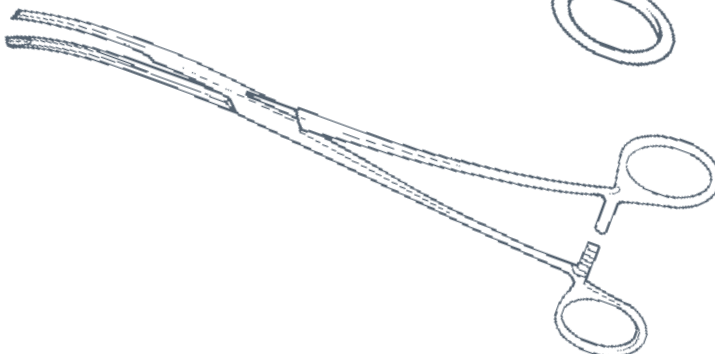
**Semb**

pneumonectomy forceps  
slight curve

2585/25 240mm

deep curve

2585/50 240mm



CLAMPS, ATRAUMATIC

THO

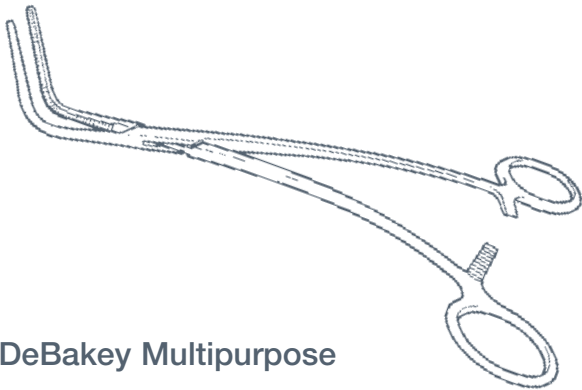

**DeBakey Multipurpose**

right angled, 1/2 serrations, 40mm jaw  
2625/05 220mm

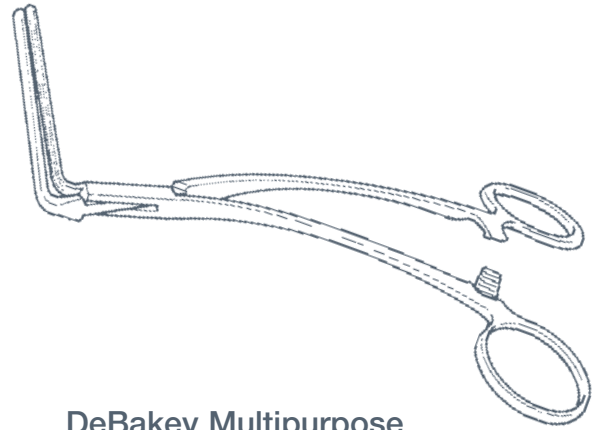

**DeBakey Multipurpose**

right angled, 1/2 serrations, 50mm jaw  
2625/10 200mm

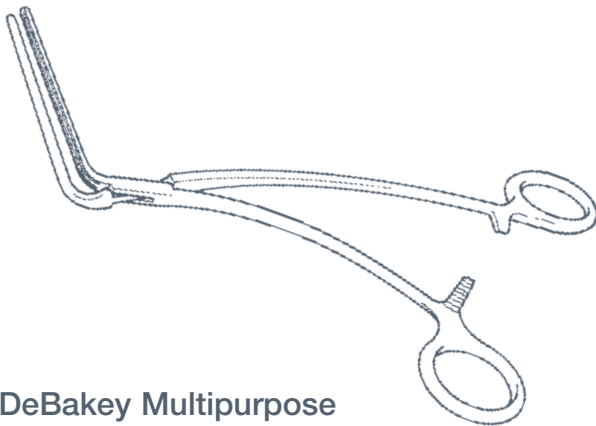

**DeBakey Multipurpose**

right angled, 1/2 serrations, 65mm jaw  
2625/15 215mm

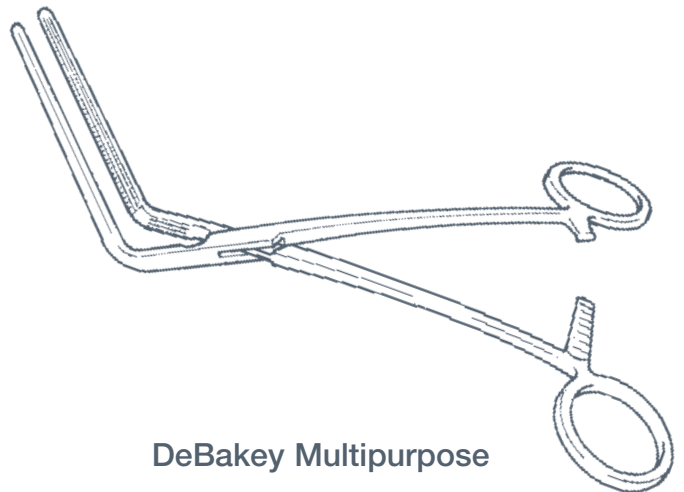

**DeBakey Multipurpose**

right angled, 1/2 serrations, 100mm jaw  
2625/20 280mm

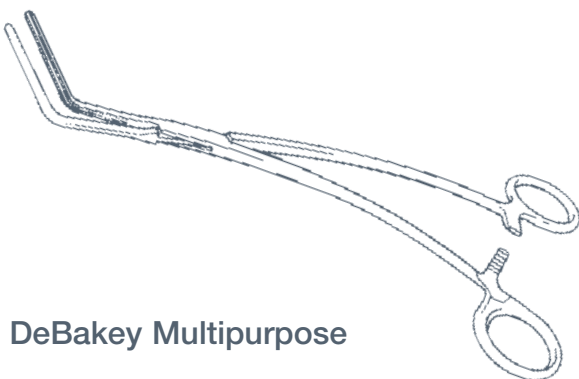

**DeBakey Multipurpose**

obtuse angled, 1/2 serrations, 50mm jaw  
2626/05 210mm

obtuse angled, 1/2 serrations, 40mm jaw  
2626/10 235mm

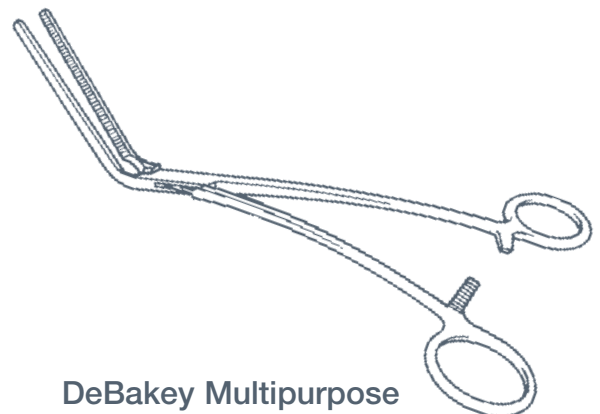

**DeBakey Multipurpose**

obtuse angled, 1/2 serrations, 65mm jaw  
2626/15 240mm

obtuse angled, 1/2 serrations, 100mm jaw  
2626/20 300mm



CLAMPS, ATRAUMATIC

THO

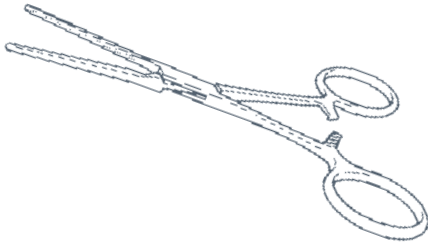

**DeBakey Ring Handle**

straight, 1/2 serrations, 45mm jaw  
2630/05 130mm

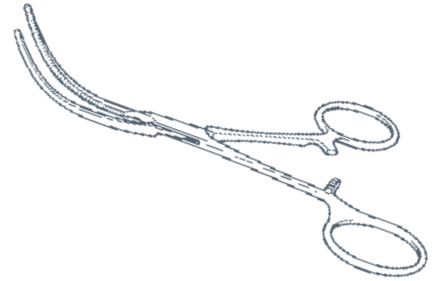

**DeBakey Ring Handle**

curved, 1/2 serrations, 45mm jaw  
2631/05 130mm

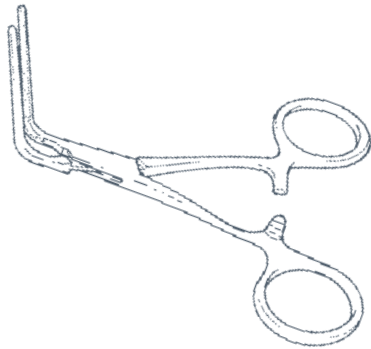

**DeBakey Ring Handle**

right angled, 1/2 serrations, 40mm jaw  
2632/05 120mm

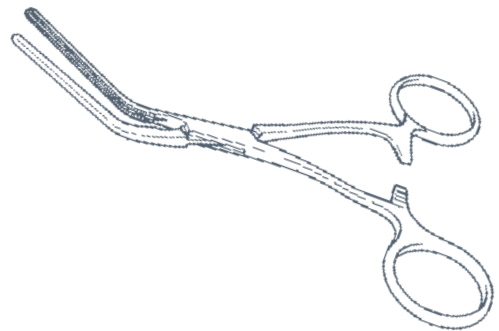

**DeBakey Ring Handle**

angled 45°, 1/2 serrations, 40mm jaw  
2633/05 115mm

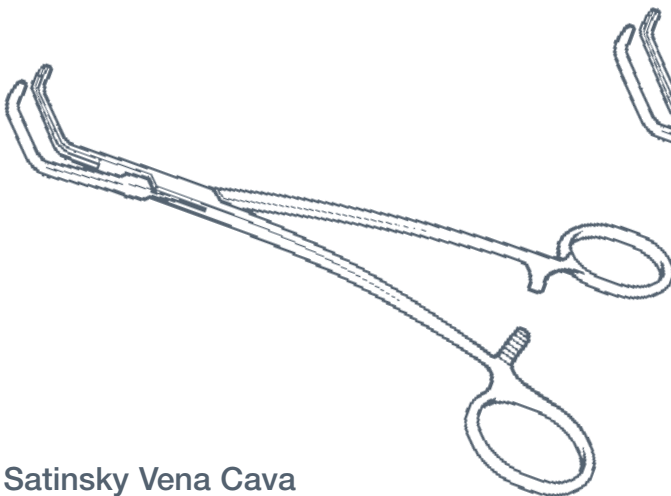

**Satinsky Vena Cava**

double angle, 1/2 serrations, 250mm  
2685/05 small, 32mm jaw

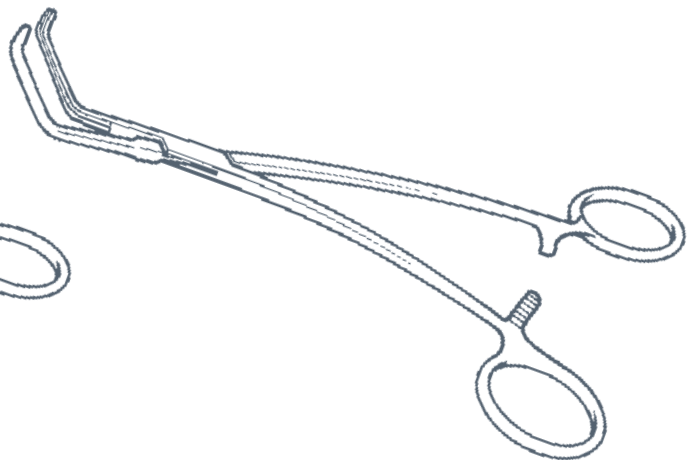

**Satinsky Vena Cava**

double angle, 1/2 serrations, 250mm  
2685/10 medium, 40mm jaw



THO

# CLAMPS, ATRAUMATIC

## Satinsky Vena Cava

double angle, 1/2 serrations, 250mm  
2685/15 large, 50mm jaw

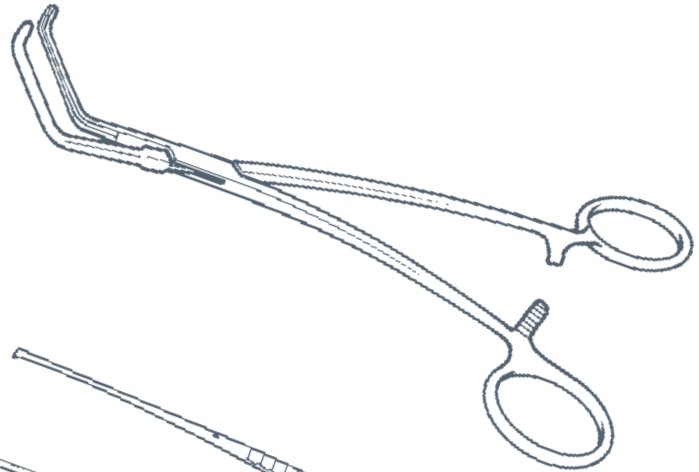

# DISSECTING FORCEPS

## Nelson

fine teeth  
2700/05 230mm

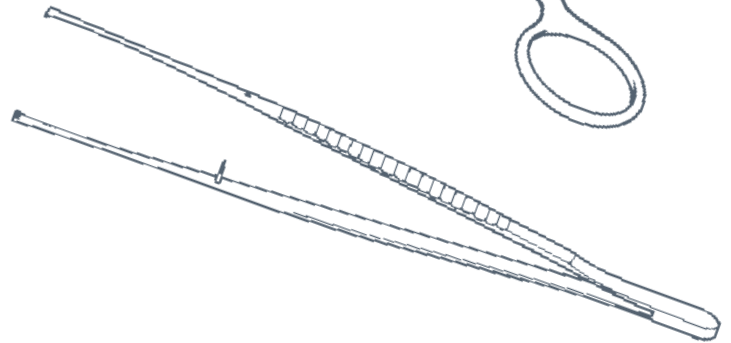

# ELEVATORS

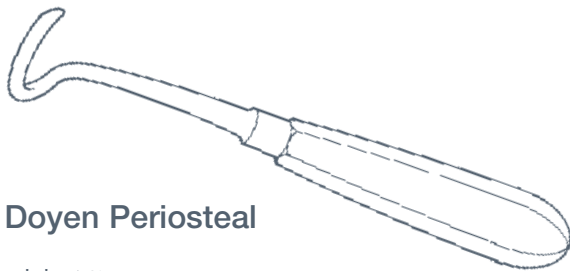

## Doyen Periosteal

adult, 165mm  
2703/25 left  
2703/50 right  
  
child  
2704/25 left  
2704/50 right

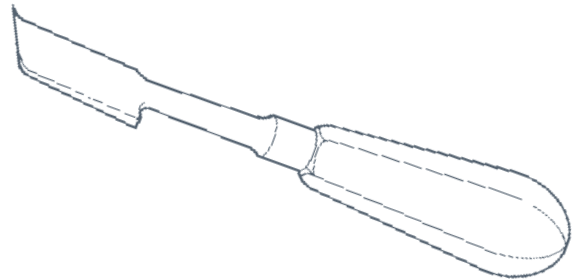

## Tudor Edwards Periosteal

length 175mm  
2705/05 12mm  
2705/10 18mm

# LUNG FORCEPS

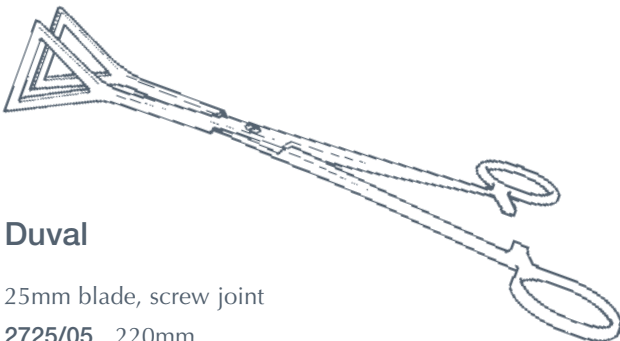

## Duval

25mm blade, screw joint  
2725/05 220mm

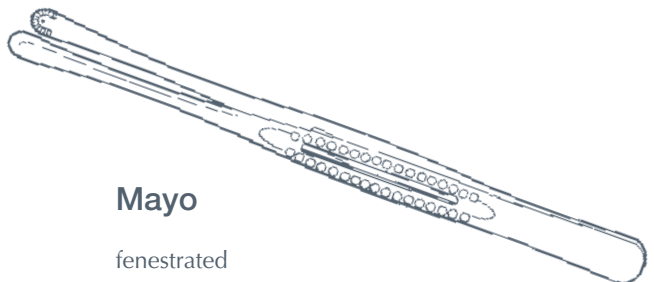

## Mayo

fenestrated  
2730/05 225mm





RETRACTORS

THO

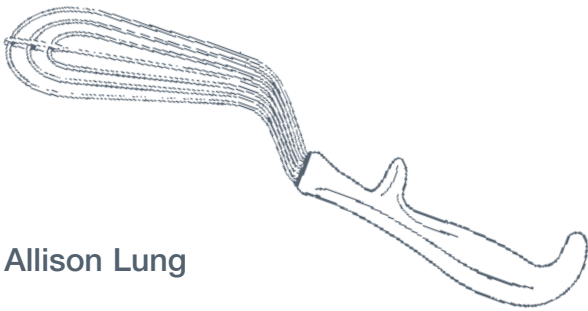

**Allison Lung**

adult  
2750/25 300mm

child  
2750/50 280mm

infant  
2750/75 280mm

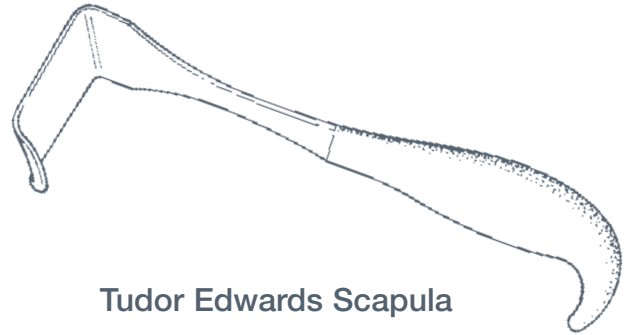

**Tudor Edwards Scapula**

2770/05 200mm, 45mm blade

RIB SHEARS

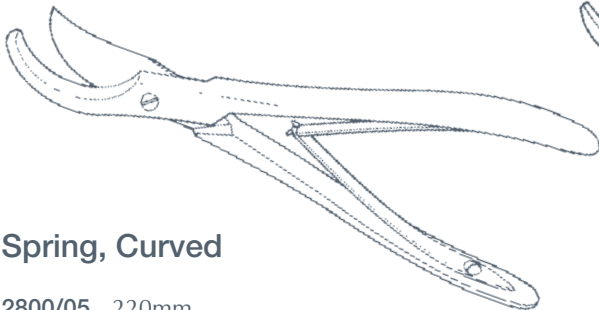

**Spring, Curved**

2800/05 220mm

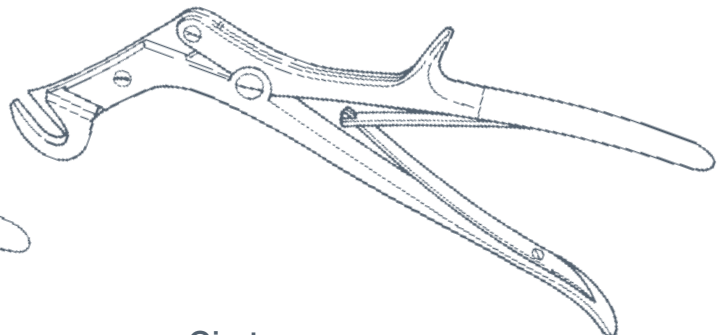

**Giertz**

2785/05 270mm

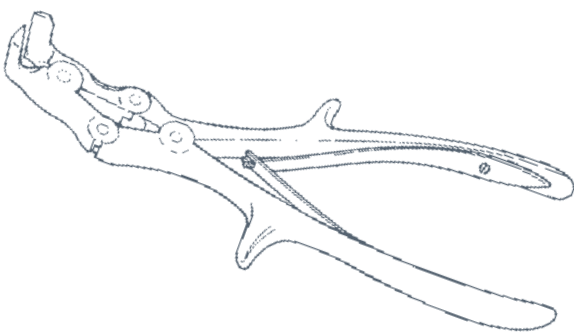

**Tudor Edwards**

compound action, anterior  
2810/05 235mm

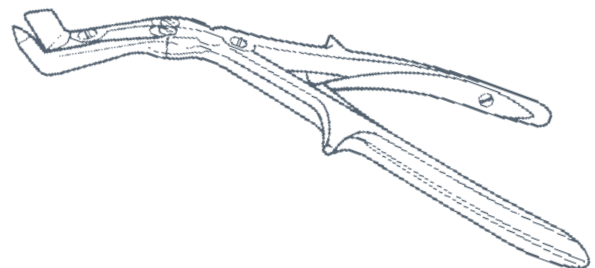

**Tudor Edwards**

compound action, posterior  
2811/05 250mm



THO

### RIB SPREADERS

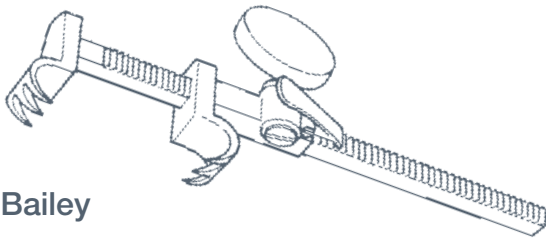

**Bailey**

2820/05 160mm

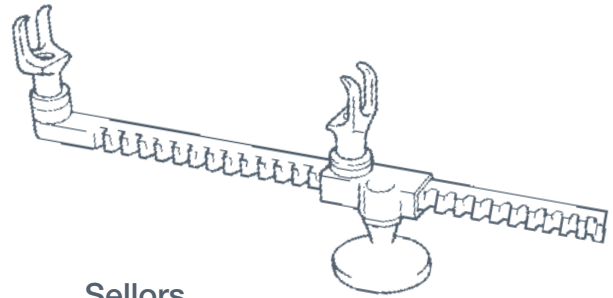

**Sellors**

approximator and spreader combined  
2860/05 200mm

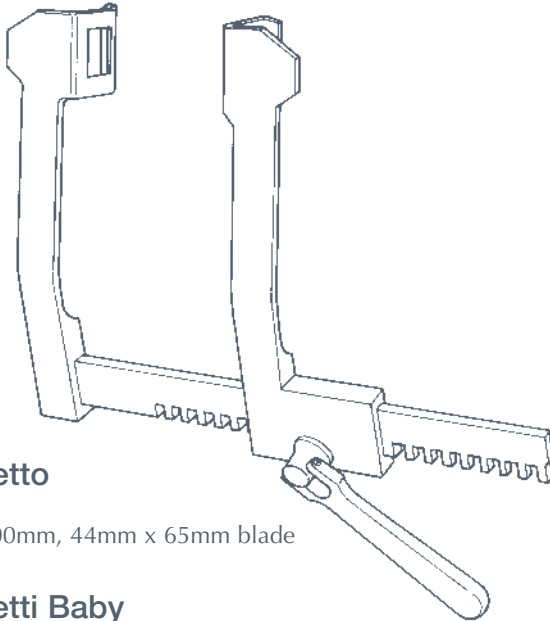

**Finocchietto**

2840/35 300mm, 44mm x 65mm blade

**Finocchietti Baby**

2841/05 105mm, 18mm x 21mm blade

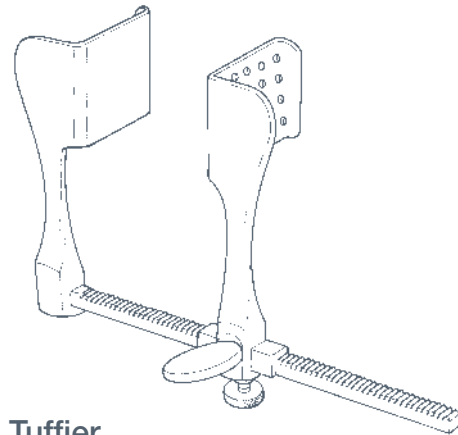

**Tuffier**

2865/05 165mm, 50mm x 45mm blade

### SCISSORS

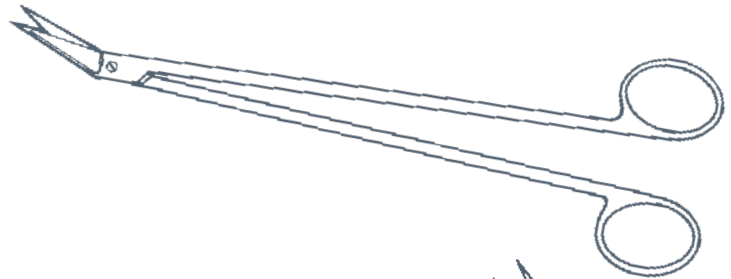

**Potts-Smith**

angled to side, 190mm  
2890/05 25°

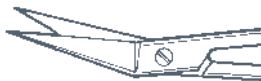

angled to side, 190mm  
2892/05 60°



angled to side, 190mm  
2891/05 45°

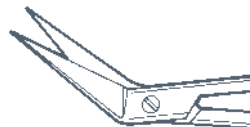

angled to side, 190mm  
2893/05 125°





SCISSORS, HARD EDGE

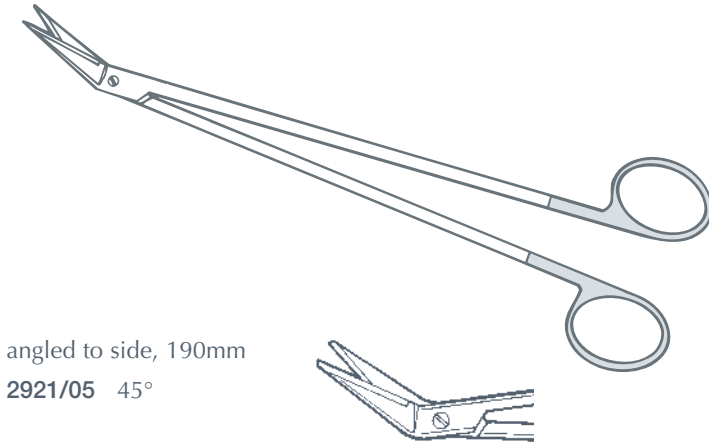

angled to side, 190mm  
2921/05 45°

Potts-Smith

angled to side, 190mm  
2920/05 25°



angled to side, 190mm  
2922/05 60°

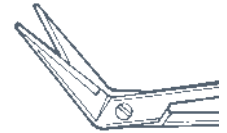

THO

TISSUE FORCEPS

DeBakey

atraumatic, 1.5mm jaw  
2940/05 150mm  
2940/10 180mm  
2940/15 195mm  
2940/20 240mm

atraumatic, 2mm jaw  
2941/05 150mm  
2941/10 180mm  
2941/15 195mm  
2941/20 240mm

atraumatic, angled, 2mm jaw  
2942/05 150mm  
2942/10 180mm  
2942/15 195mm  
2942/20 240mm

atraumatic, 2.4mm jaw  
2943/05 150mm  
2943/10 180mm  
2943/15 195mm  
2943/20 240mm

atraumatic, 2.7mm jaw  
2944/05 150mm  
2944/10 180mm  
2944/15 195mm  
2944/20 240mm

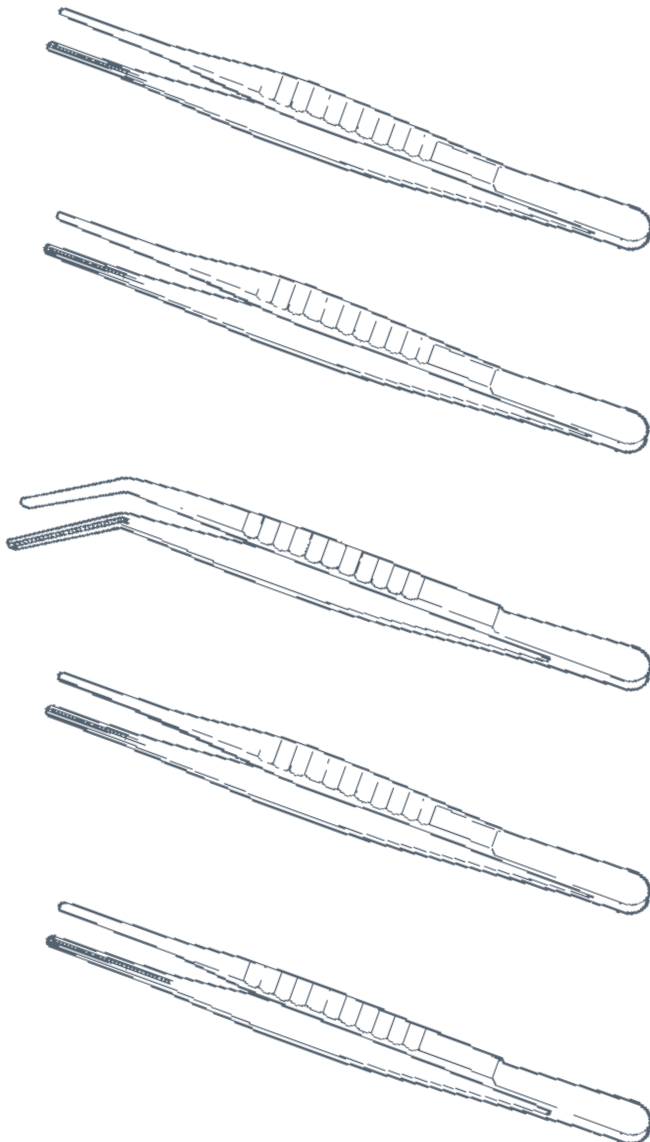



GYN





BIOPSY PUNCH

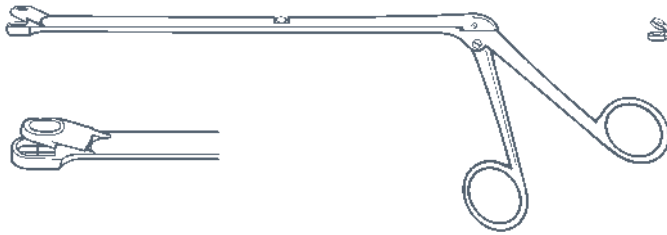

**Eppendorf**

3005/05 200mm effective length

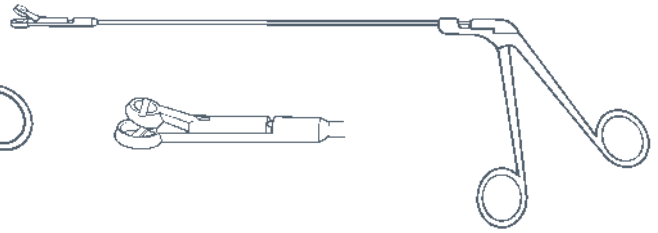

**Leech Wilkinson**

3008/05 200mm effective length

GYN

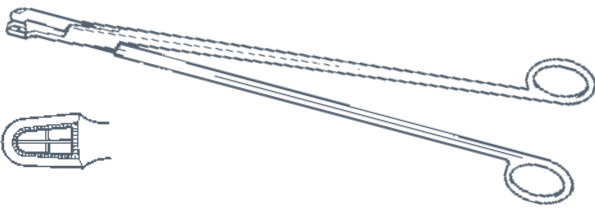

**Schubert**

straight

3011/05 210mm

3011/10 290mm



**Schubert**

angled shank

3012/05 260mm

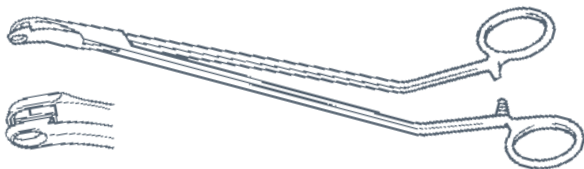

**Van Doren**

curved

3015/05 265mm angled shank

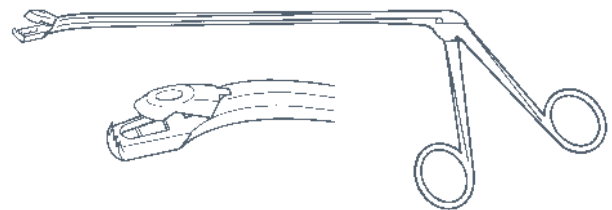

**Wittner**

curved to side

3019/05 230mm effective length



## CANNULA

### Leech Wilkinson

luer fitting, complete with stilette, 265mm

3025/05 cone 10mm to 25mm

3025/10 cone 13mm to 30mm

3025/15 cone 16mm to 30mm



### Spackman Intra Uterine

with adjustable plate for use with  
vulsellum forceps, luer fitting  
(forceps must be ordered separately)

3031/05 360mm



### Female

round, with solid end, plated, 165mm

3038/05 6 Eg

3038/10 7 Eg

3038/15 8 Eg

3038/20 9 Eg

3038/25 10 Eg



### Rotunda

oval, with solid end, plated, 200mm

3041/05 8 Eg

3041/10 10 Eg

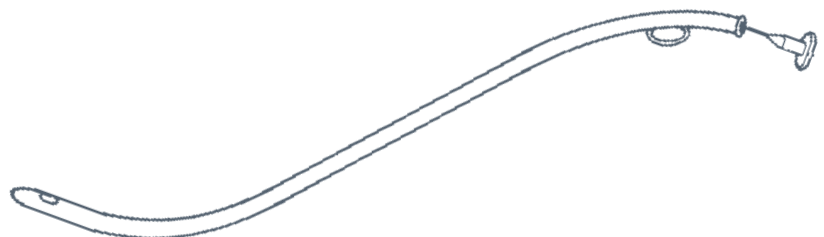



CLAMPS

GYN

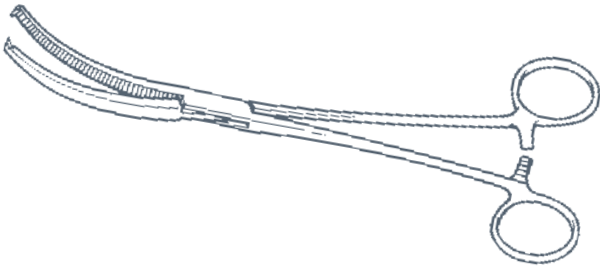

**Berkeley- Bonney Hysterectomy**

curved on flat, 1/2 teeth  
3050/05 200mm

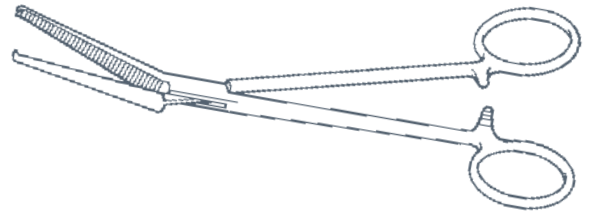

**Bonney Hysterectomy**

angled on flat, 1/2 teeth  
3053/05 195mm

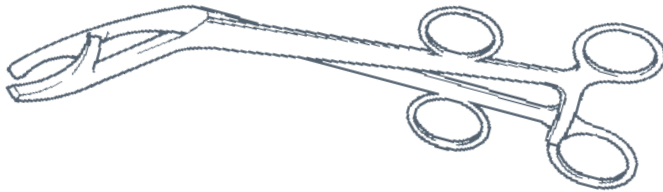

**Bonney Myomectomy**

screw joint  
3056/05 265mm

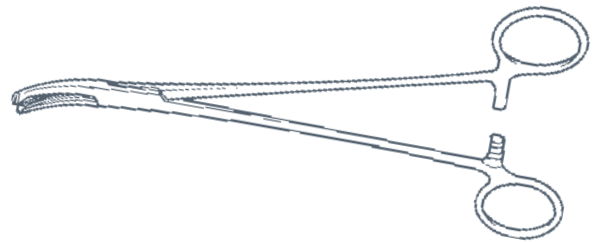

**Faure**

longitudinal serrations, toothed  
3060/05 200mm

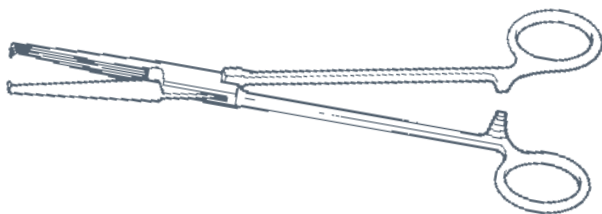
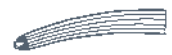

**Gwilliam**

straight, longitudinal serrations,  
1/2 teeth  
3065/05 200mm

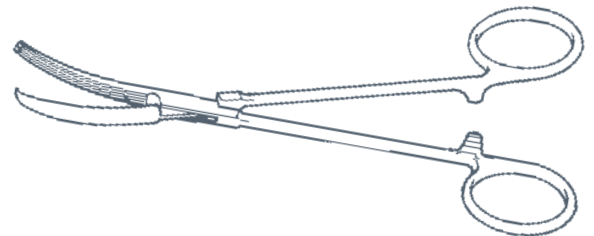
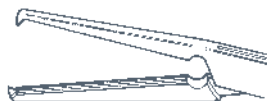

**Gwilliam**

curved on flat, longitudinal serrations,  
1/2 teeth  
3066/05 200mm

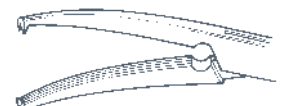



## CLAMPS

### Heaney

curved, single tooth  
3070/10 210mm



curved, double tooth  
3071/10 210mm

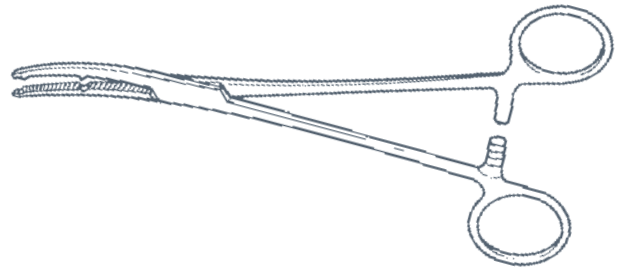

GYN

### Hysterectomy, Atraumatic

straight, 2/3 teeth  
3075/05 220mm  
3075/10 240mm



slight curve, 2/3 teeth  
3076/05 220mm  
3076/10 240mm

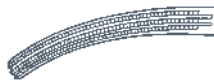

full curve, 2/3 teeth  
3077/05 210mm  
3077/10 230mm

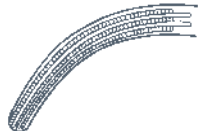

angled, 2/3 teeth  
3078/05 210mm  
3078/10 230mm

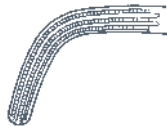

3078/95 set of 8 clamps

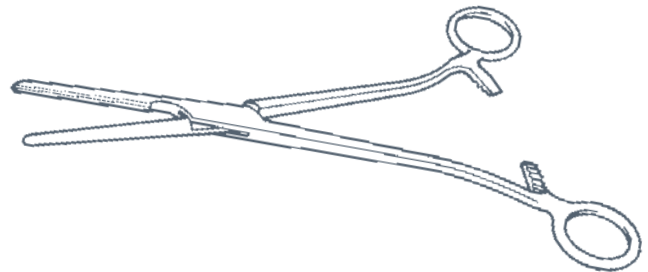

### Maingot

curved on flat, 1/2 teeth  
3085/05 200mm  
3085/10 240mm

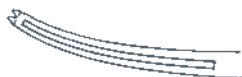

straight, 1/2 teeth  
3086/05 200mm

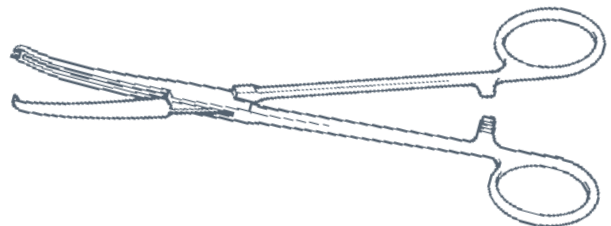





## CURETTES

GYN

**Sharman**

endometrial biopsy  
3125/05 220mm

**Sims Uterine**

single ended  
blunt, pliable shaft, 255mm  
3130/05 6mm

3130/10 10mm

3130/15 13mm

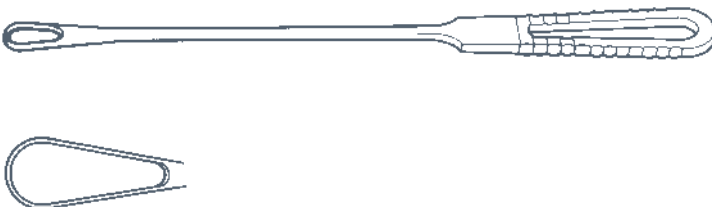
**Sims Uterine**

single ended  
sharp, pliable shaft, 255mm  
3131/05 6mm

3131/10 10mm

3131/15 13mm

**Sims Uterine**

double ended  
blunt/sharp combined  
3132/05 250mm

sharp/sharp combined  
3133/05 250mm



## DILATORS, CERVIX



### Hegar

single ended, 185mm

<b>3160/05</b>	2mm	<b>3160/50</b>	11mm
<b>3160/10</b>	3mm	<b>3160/55</b>	12mm
<b>3160/15</b>	4mm	<b>3160/60</b>	13mm
<b>3160/20</b>	5mm	<b>3160/65</b>	14mm
<b>3160/25</b>	6mm	<b>3160/70</b>	15mm
<b>3160/30</b>	7mm	<b>3160/75</b>	16mm
<b>3160/35</b>	8mm	<b>3160/80</b>	17mm
<b>3160/40</b>	9mm	<b>3160/95</b>	set of 16 sizes
<b>3160/45</b>	10mm		



### Hegar

double ended, 220mm

<b>3161/05</b>	3/4mm
<b>3161/10</b>	5/6mm
<b>3161/15</b>	7/8mm
<b>3161/20</b>	9/10mm
<b>3161/25</b>	11/12mm
<b>3161/30</b>	13/14mm
<b>3161/35</b>	15/16mm
<b>3161/40</b>	17/18mm
<b>3161/95</b>	set of 8 sizes

GYN

## DRESSING FORCEPS



### Bozemann Uterine

**3170/05** grooved jaw, 265mm

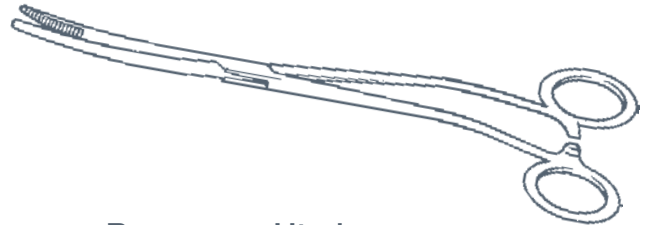

### Bozemann Uterine

**3171/05** serrated jaw, 265mm

## GUIDES

### Pudendal Nerve Block

luer, complete with needle

**3175/05** 140mm



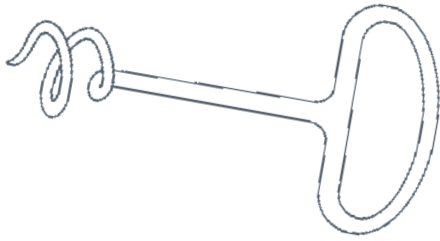

## MYOMA SCREW

**Doyen**

for abdominal use

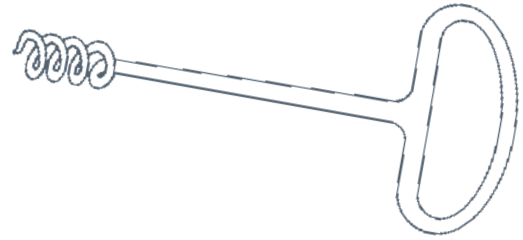
**3180/05** 150mm**Doyen**

for vaginal use

**3181/05** 175mm

GYN

## OBSTETRIC FORCEPS

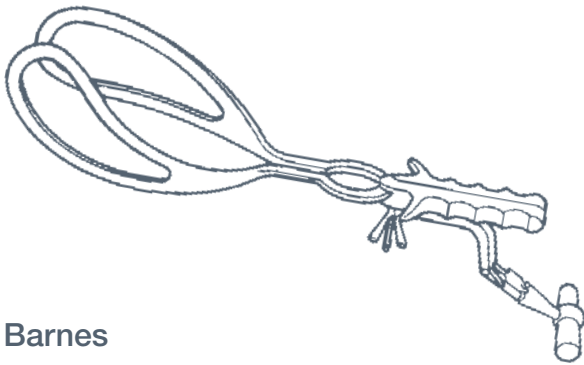
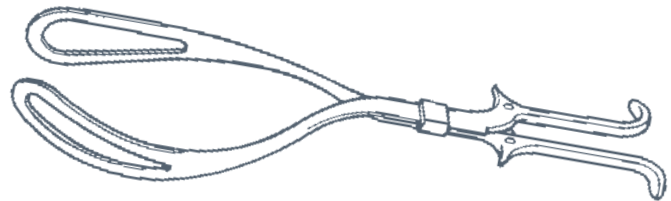
**Barnes**with Simpson handle and Neville axis  
traction rod**3190/05** 410mm**Kielland****3200/05** 410mm**Simpson**

short model

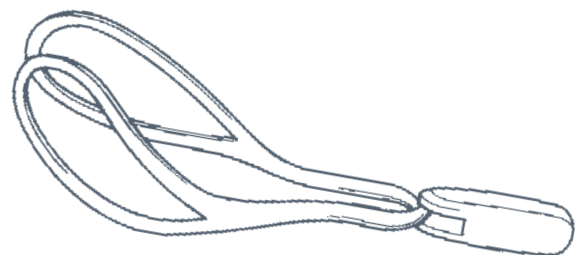
**3205/05** 280mm**Wrigley**

short model

**3215/05** 250mm



# OVUM FORCEPS

## McClintock

curved, screw joint  
3225/05 240mm

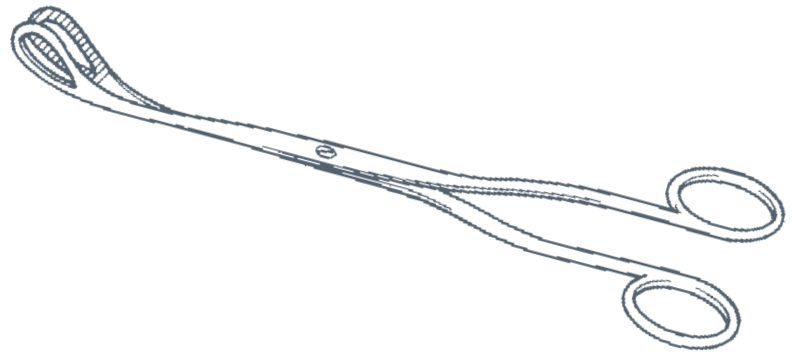

**GYN**

# PERITONEUM FORCEPS

## Goodwin Amniotomy

double curved  
3265/05 250mm

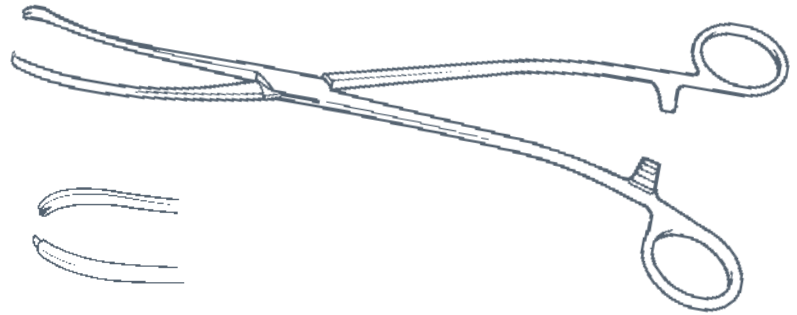

## Green Armytage

straight, screw joint  
3270/05 210mm

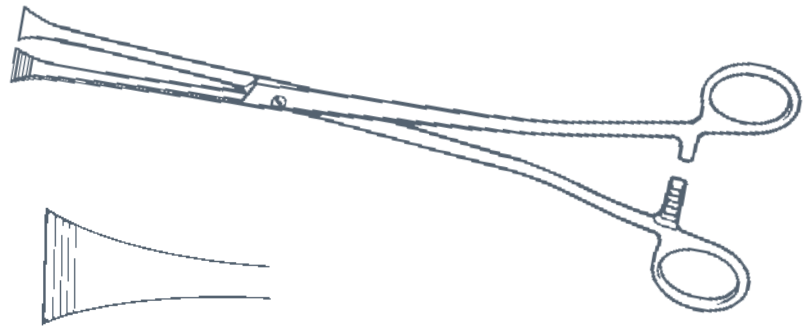

## Green Armytage

angled, screw joint  
3271/05 200mm

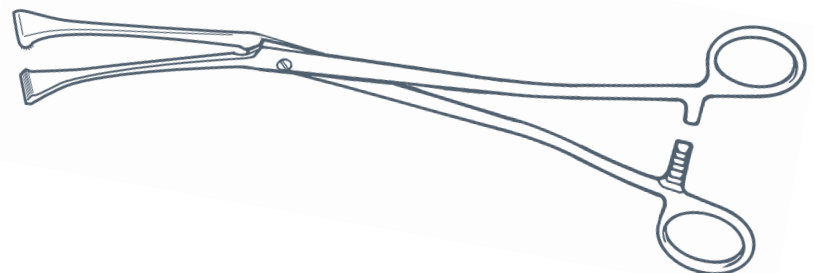

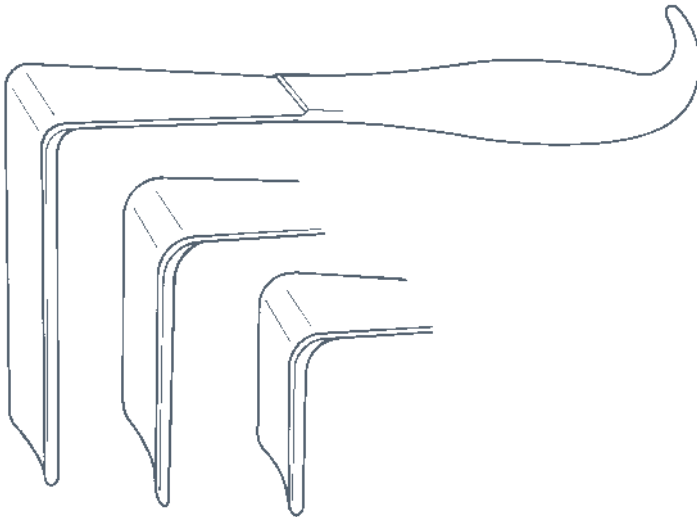

## RETRACTORS

**Doyen (Pozzi)**

3295/05 small, 48mm x 60mm

3295/10 medium, 48mm x 90mm

3295/15 large, 48mm x 124mm

GYN

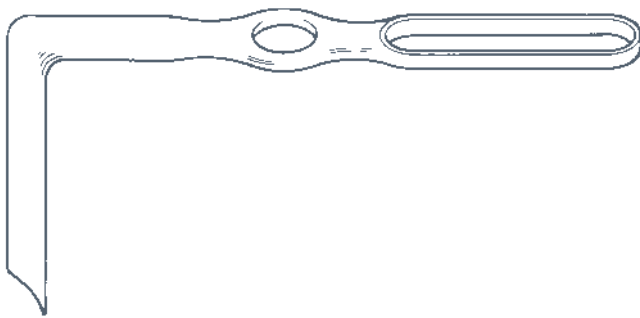
**Landon Vaginal**

3305/05 90mm x 25mm blade

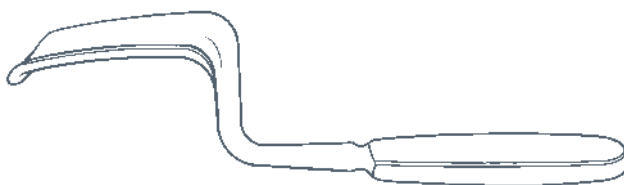
**Wertheim**

3310/05 95mm x 38mm blade

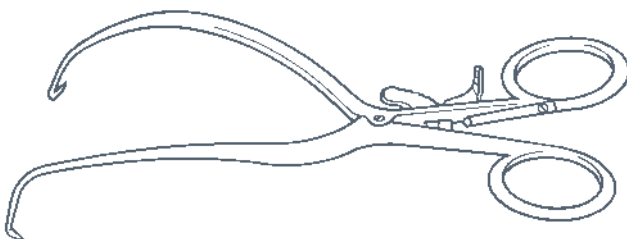
RETRACTORS,  
SELF-RETAINING**Gelpi Vulva**

3315/05 170mm



## SCISSORS

### Barnes (Lawson Tait)

episiotomy

3320/05 140mm

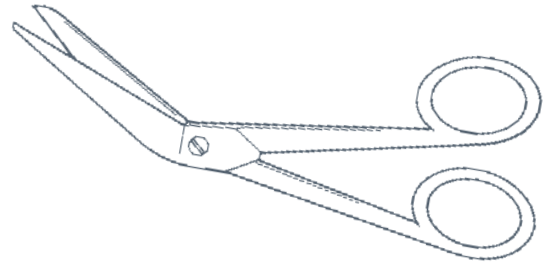

GYN

### Braun-Stadler

episiotomy

3325/05 140mm

3325/10 200mm

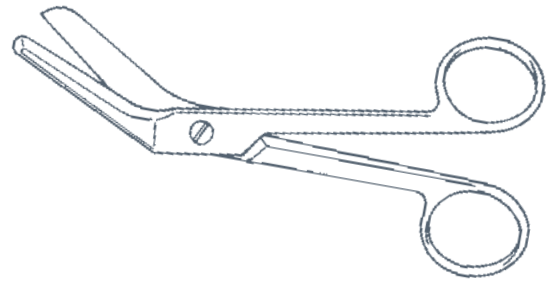

### Chassar Moir

curved, blunt points

3327/25 180mm

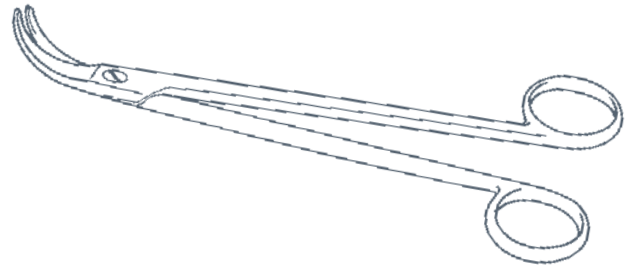

### Chassar Moir

angled on flat, blunt points

3327/50 200mm

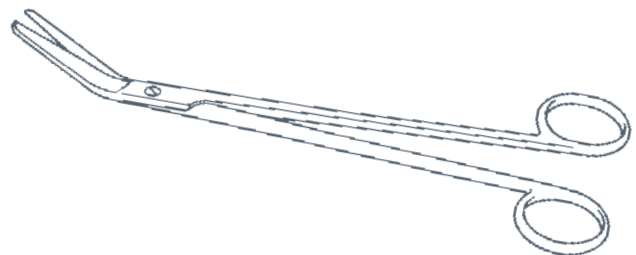

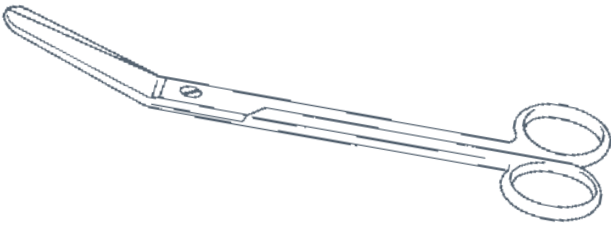

## SCISSORS

**Currie Uterine**

angled on flat  
3329/05 200mm

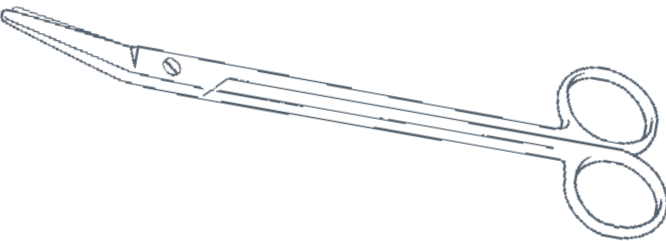
**Monaghan**

angled on flat, heavy pattern  
3331/05 220mm

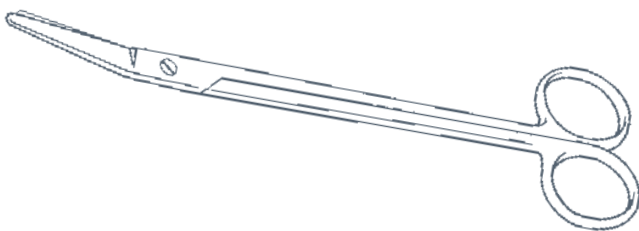
**Monaghan**

angled on flat, light pattern  
3332/05 210mm

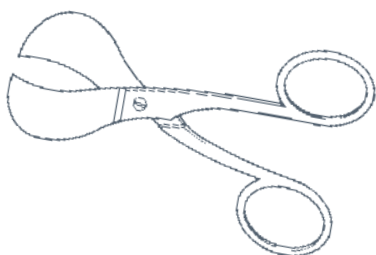
**Umbilical**

American Pattern  
3335/05 100mm



# SCISSORS

## Uterine

straight  
3340/05 230mm

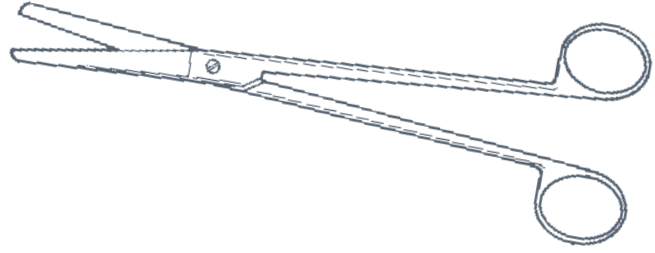

## Uterine

curved  
3341/05 230mm

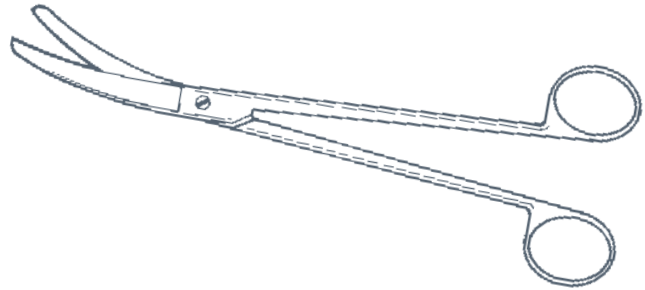

## Uterine

angled  
3342/05 230mm

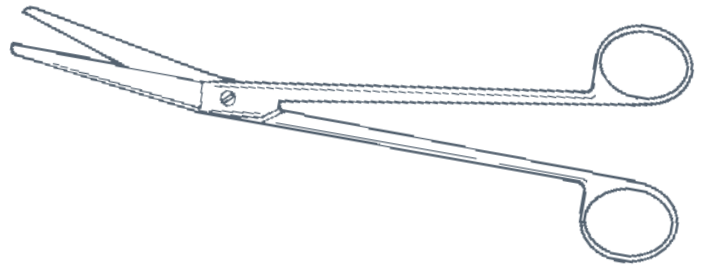

## Vant

episiotomy  
3345/05 240mm

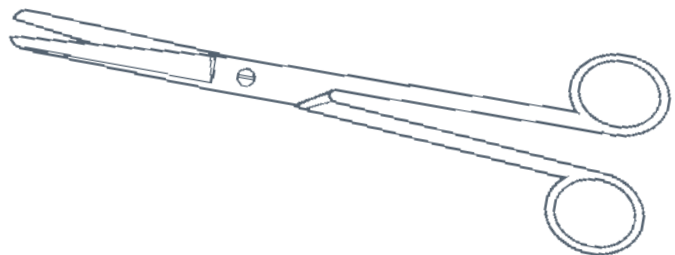

GYN





## SOUNDS

**Galabin Uterine**

malleable, shaft graduated in cms

**3355/05** 290mm**Horrocks Uterine**

malleable, shaft graduated in 2cm intervals

**3360/05** 300mm**Sims Uterine**

malleable

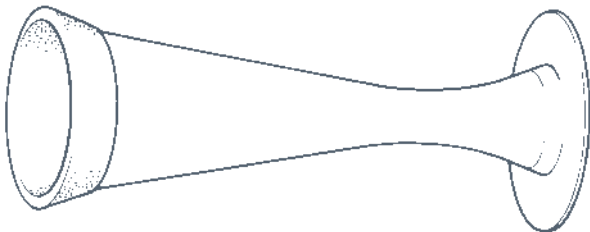
**3370/05** 320mm**Pinard Foetal**

aluminium

**3380/05** 140mm

plastic

**3381/05** 140mm

## STETHOSCOPES

**Gillies****3390/05** 175mm

## SUCTION TUBES

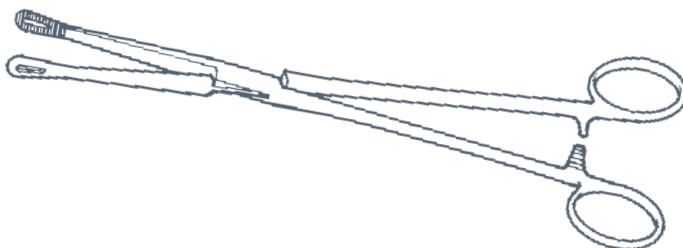

## UTERINE FORCEPS

**Bonney Polypus**

oval

**3400/05** 240mm



## VAGINAL SPECULA

**GYN**

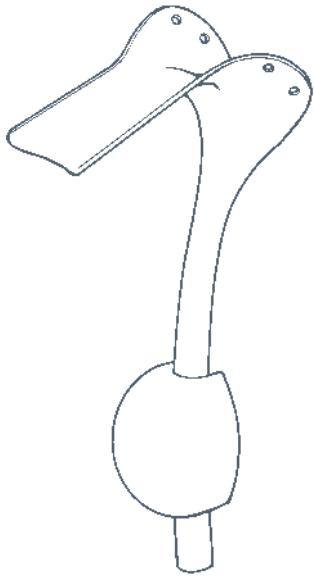

### Auvard

- 3425/05 with detachable weight
- 3426/05 with fixed weight

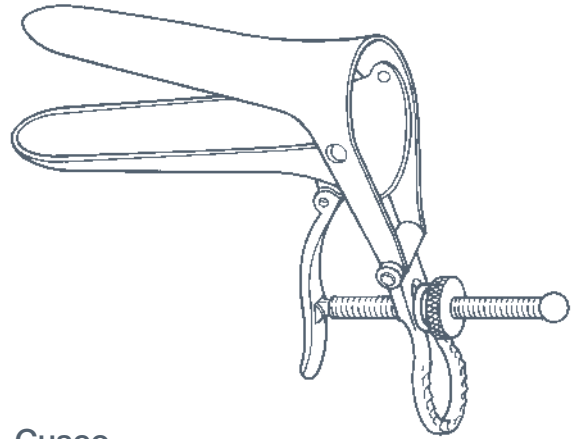

### Cusco

- 3430/05 virgin
- 3430/10 small
- 3430/15 medium
- 3430/20 large

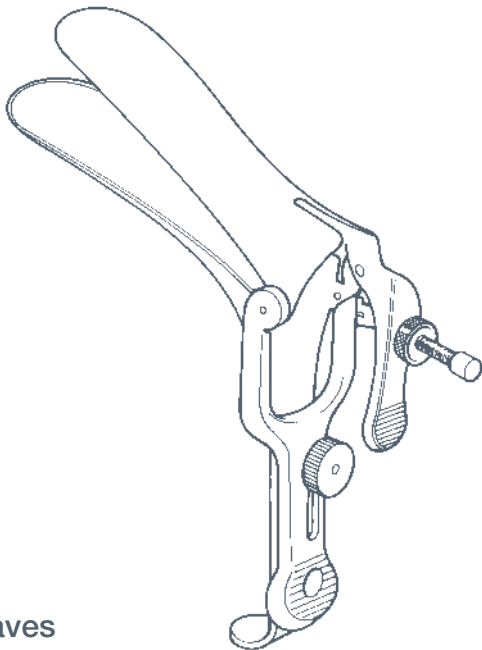

### Graves

- 3435/05 small
- 3435/10 medium
- 3435/15 large

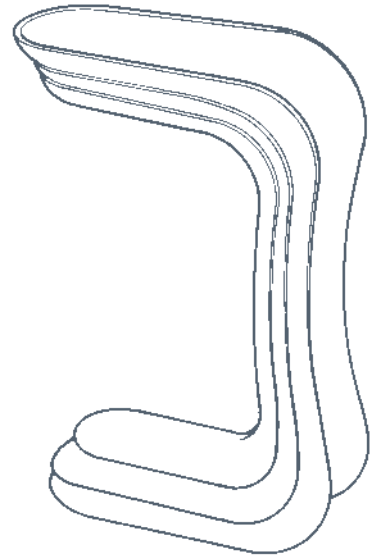

### Sims

- double ended
- 3445/05 small
- 3445/10 medium
- 3445/15 large
- 3445/95 set of 3



VULSELLUM FORCEPS

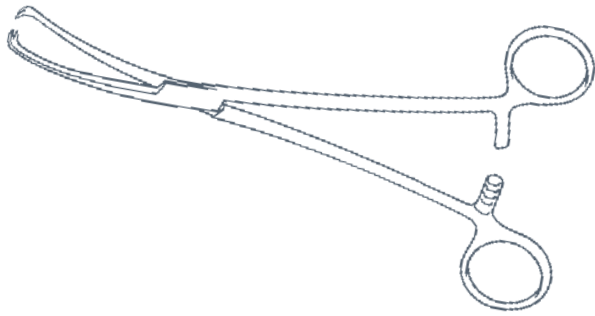

**Lewer**

2/2 teeth  
3455/10 230mm

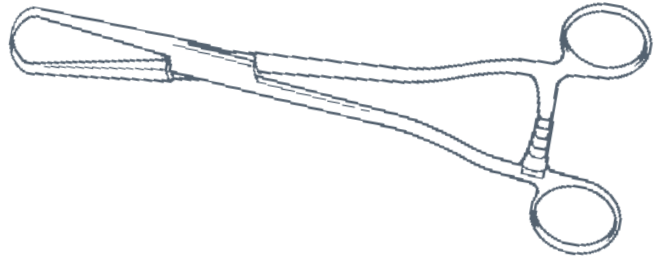

**Luer**

1/1 teeth  
3460/05 230mm

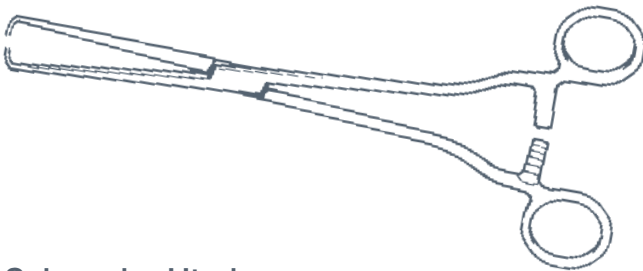

**Schroeder Uterine**

1/1 teeth  
3465/05 225mm

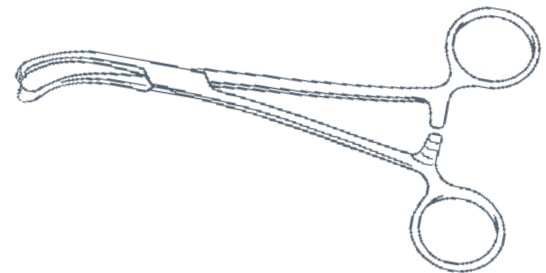

**Teales Uterine**

curved, 3/4 teeth  
3470/05 180mm  
3470/10 230mm



straight, 3/4 teeth  
3471/10 230mm

GYN



URO





## BOUGIES

### Clutton Urethral Sounds



tapered, length 265mm

<b>3505/05</b>	6/10 fg	<b>3505/40</b>	20/24 fg
<b>3505/10</b>	8/12 fg	<b>3505/45</b>	22/26 fg
<b>3505/15</b>	10/14 fg	<b>3505/50</b>	24/28 fg
<b>3505/20</b>	12/16 fg	<b>3505/55</b>	26/30 fg
<b>3505/25</b>	14/18 fg	<b>3505/60</b>	28/32 fg
<b>3505/30</b>	16/20 fg	<b>3505/95</b>	set of 12
<b>3505/35</b>	18/22 fg		

URO

## CATHETER INTRODUCERS



### Foley Balloon

curved

**3550/05** 455mm



### Guyon

curved, 430mm

**3560/05** small tip 2mm diameter

**3560/10** large tip 4mm diameter



# CLAMPS

## Thomson-Walker Pedicle

angled, screw joint  
3580/05 200mm

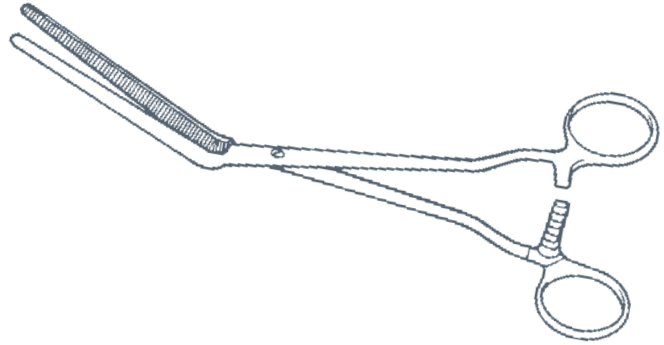

## Thomson-Walker Penile

cross action  
3581/05 115mm

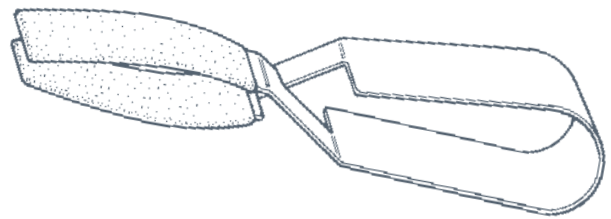

# CLAMPS, ATRAUMATIC

## Herrick Kidney Pedicle

1/2 serrations, double angle  
3590/05 265mm

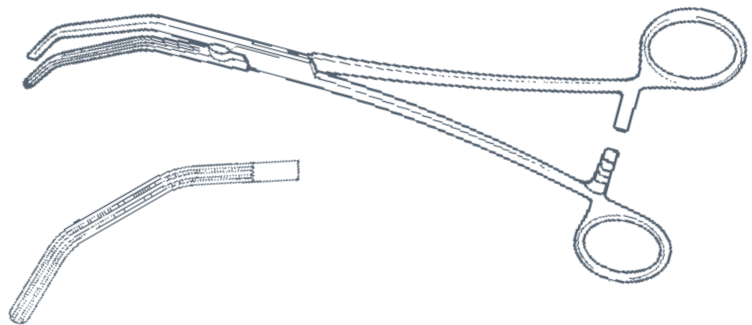

# DISSECTING FORCEPS

## Millins

3/4 teeth  
3610/05 225mm

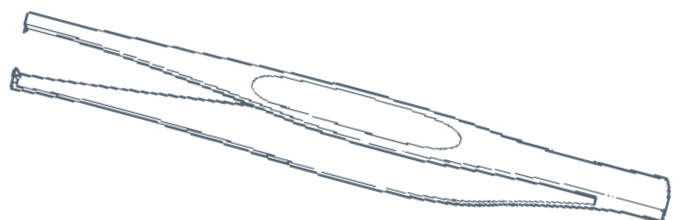

URO



## RETRACTORS

**Millin Bladder**

neck spreader, cross action

3700/25 240mm

## STONE FORCEPS

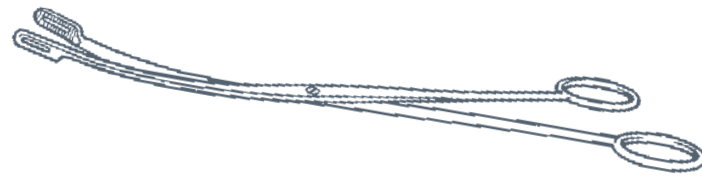
**Randall Renal Calculus**

screw joint, fenestrated jaw

3735/05 shape A, 230mm

**Randall Renal Calculus**

screw joint, fenestrated jaw

3736/05 shape B, 210mm

**Randall Renal Calculus**

screw joint, fenestrated jaw

3737/05 shape C, 195mm

**Randall Renal Calculus**

screw joint, fenestrated jaw

3738/05 shape D, 180mm



PRO







BIOPSY FORCEPS

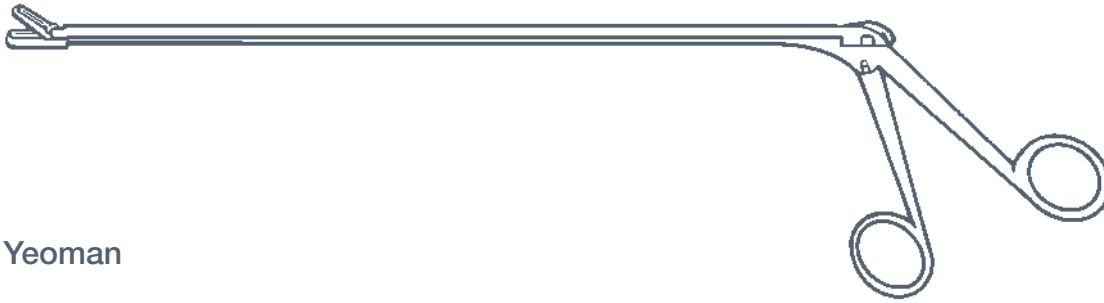

Yeoman

basket-jawed to use through sigmoidoscope

fig. 2

- 3819/05 250mm effective length
- 3819/10 355mm effective length
- 3819/15 430mm effective length



fig. 3

- 3820/05 250mm effective length
- 3820/10 355mm effective length
- 3820/15 430mm effective length

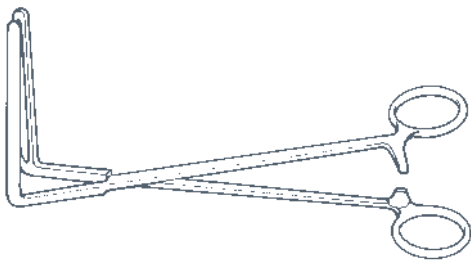

Finch Rectal Excision

with hollowed jaws

- 3830/05 215mm, 75mm blade

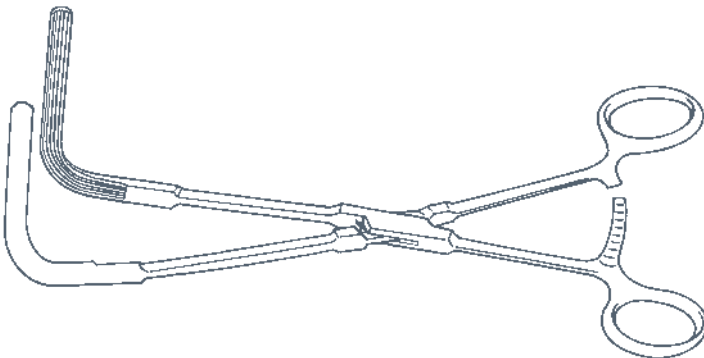

Lloyd-Davies Rectal Excision

longitudinal serrations

- 3833/05 305mm, 70mm blade

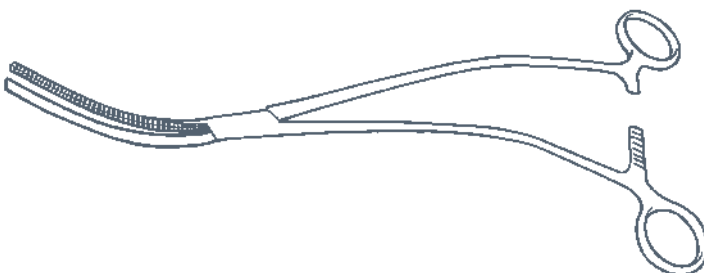

CLAMPS, ATRAUMATIC

Einsell Foss Colon Resection

curved

- 3837/05 305mm

PRO



# CLAMPS, ATRAUMATIC

## Hayes Colon Resection

jaws angled 70°

3840/05 260mm, 80mm jaws

3840/10 280mm, 100mm jaws

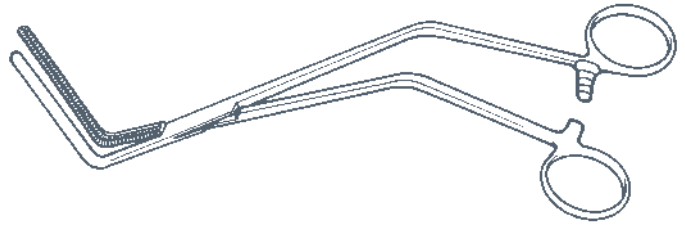

# DILATORS

## St Marks Rectal

plastic

3845/05 small

3845/10 large

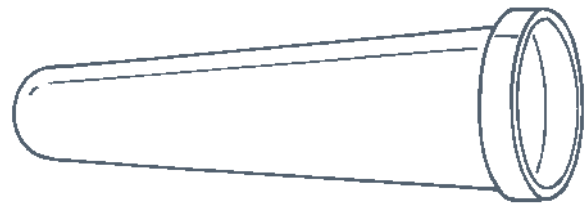

PRO

# DIRECTORS

## Lockhart Mummery Fistula

length 165mm

3850/05 No.1 straight



3850/10 No.2 45° curve



3850/15 No.3 90° curve



3850/20 No.4 Retrograde





## DISSECTING FORCEPS

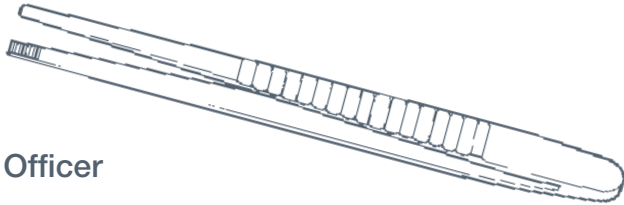

### Officer

serrated

**3855/05** 150mm

**3855/10** 200mm

**3855/15** 250mm

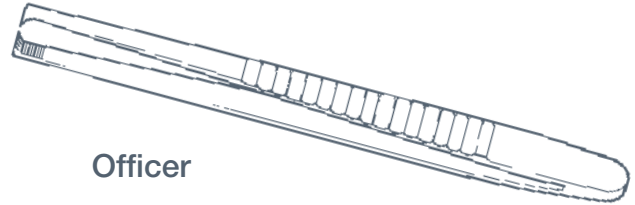

### Officer

2/3 teeth



**3856/05** 150mm

**3856/10** 200mm

4/5 teeth



**3857/05** 150mm

**3857/10** 200mm

**3857/15** 250mm

## HAEMORRHOID LIGATOR SET

PRO

### Barron

comprising ligator, conical loader,  
300 'O' rings and handle

**3860/25** 215mm, complete

**3860/50** spare conical loader

**3860/55** spare rings, pack of 300

**3860/60** spare handle

**3860/65** spare stem

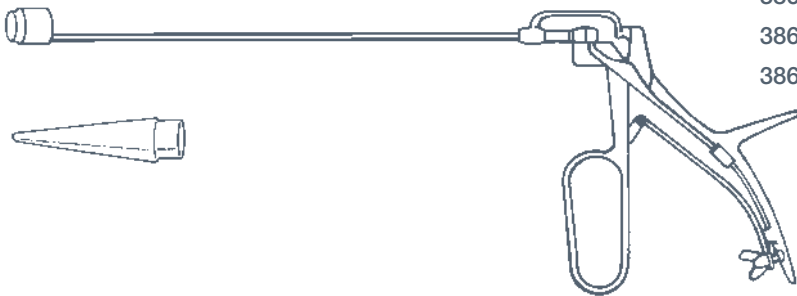

### McGivney

comprising ligator, conical loader,  
300 'O' rings and handle

**3861/25** complete

**3861/50** spare conical loader

**3861/55** spare ligator

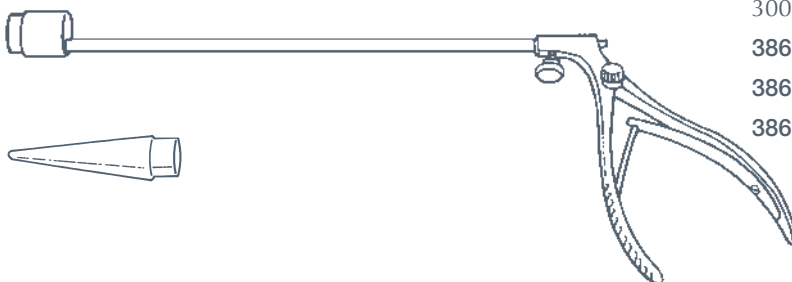



# HAEMORRHOID SEIZING FORCEPS

## St George's Pattern

3/4 teeth  
3863/05 190mm

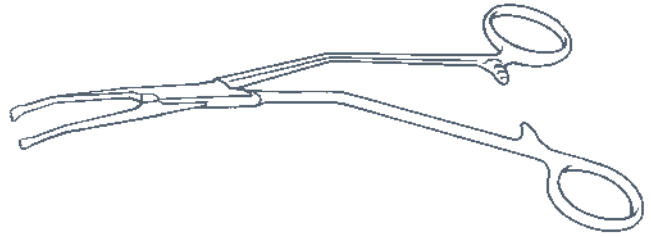

# PROCTOSCOPES

## Kelly

with obturator  
3865/05 22mm x 50mm  
3865/10 22mm x 100mm  
3865/15 22mm x 140mm  
3865/20 22mm x 200mm

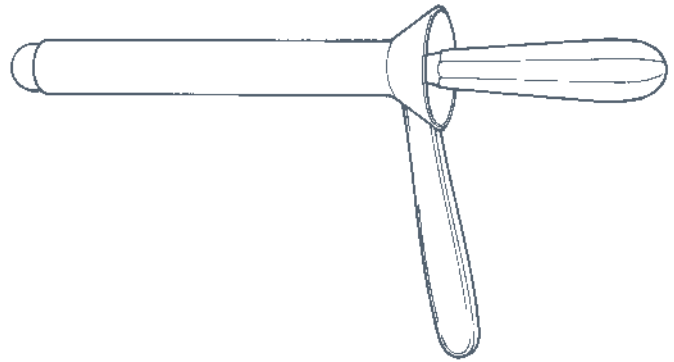

PRO

# RECTAL SPECULA

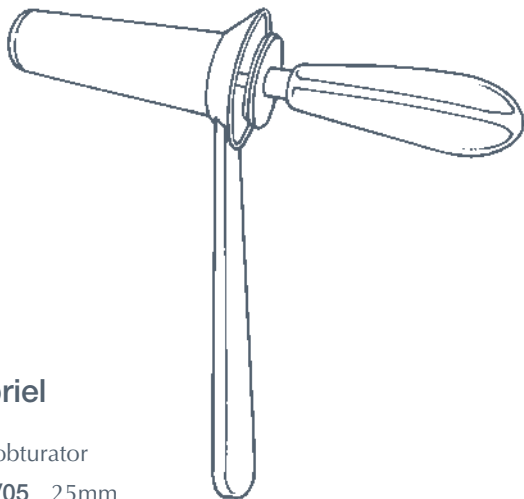

## Gabriel

with obturator  
3869/05 25mm

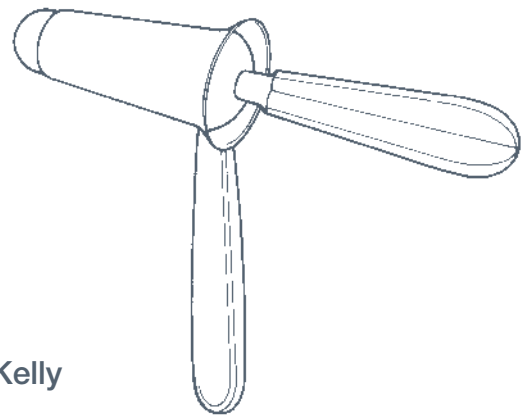

## Kelly

with obturator  
3873/05 21mm diameter  
3873/10 27mm diameter



## RECTAL SPECULA

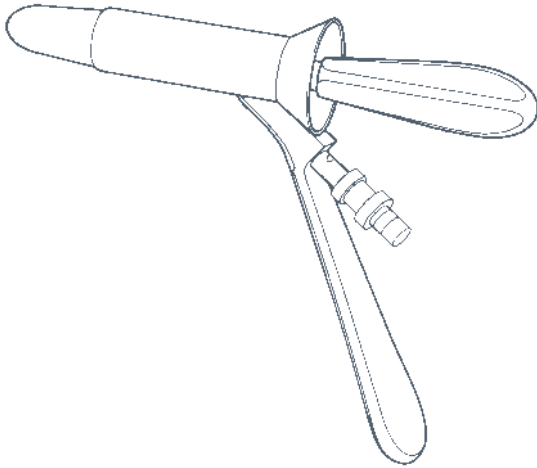

### Naunton Morgan

with obturator

3875/05 17mm diameter

3875/10 20mm diameter

3875/15 24mm diameter

## RETRACTORS

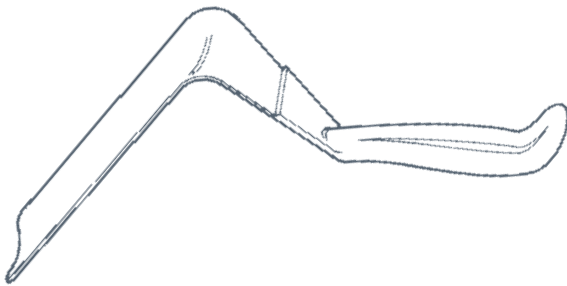

### Lloyd-Davies

short, without tapered end

3895/05 125mm x 55mm

long, with tapered end

3895/10 170mm x 65mm x 50mm

PRO

## RETRACTORS, SELF-RETAINING

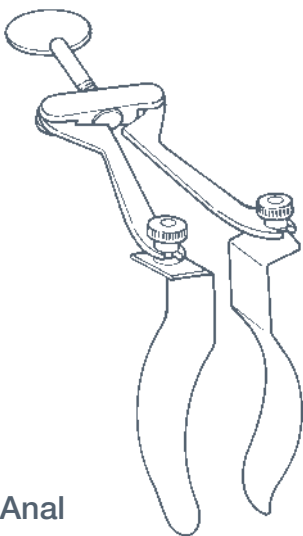

### Park Anal

adult

3900/05 130mm, 95mm blades

child

3900/25 130mm, 70mm blades

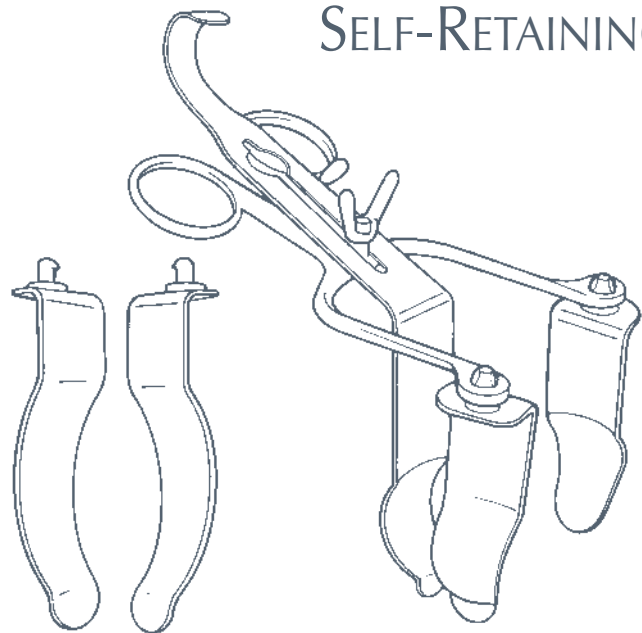

### Park Combined

with 2 sets of interchangeable blades and  
one adjustable centre blade, 140mm

3905/05 complete



# SCISSORS

## Abel Abdominal-Perineal

straight  
3915/05 320mm

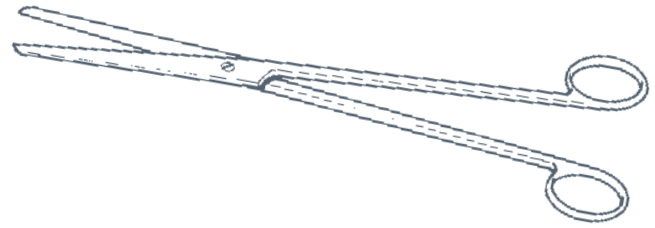

## Goligher

straight  
3920/05 300mm

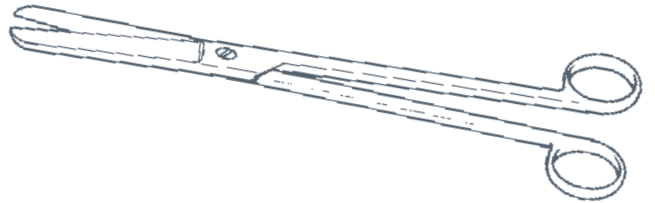

## Goligher

curved  
3921/05 300mm

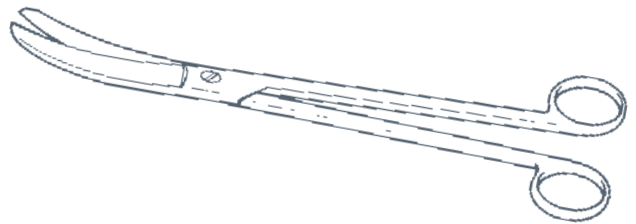

## Lloyd-Davies Rectal

straight, flattened blades, blunt points  
3925/05 265mm

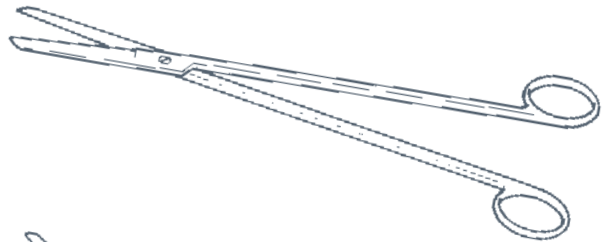

## Lloyd-Davies Rectal

curved on flat, flattened blades, blunt points  
3926/05 265mm

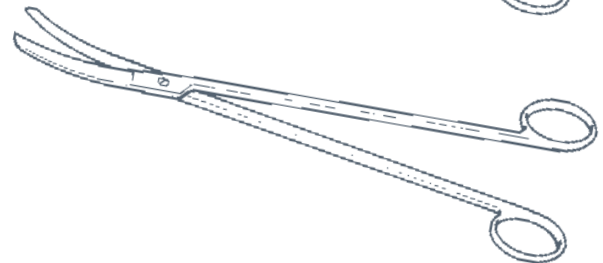

## Parks' Lower Colonic

angled on side, blunt/blunt  
3928/25 170mm, blades curved to right

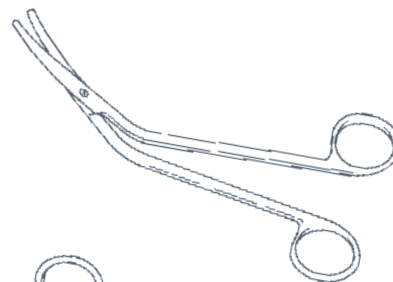

## Parks' Lower Colonic

angled on side, blunt/blunt  
3928/50 170mm, blades curved to left



PRO



## SIGMOIDOSCOPIES

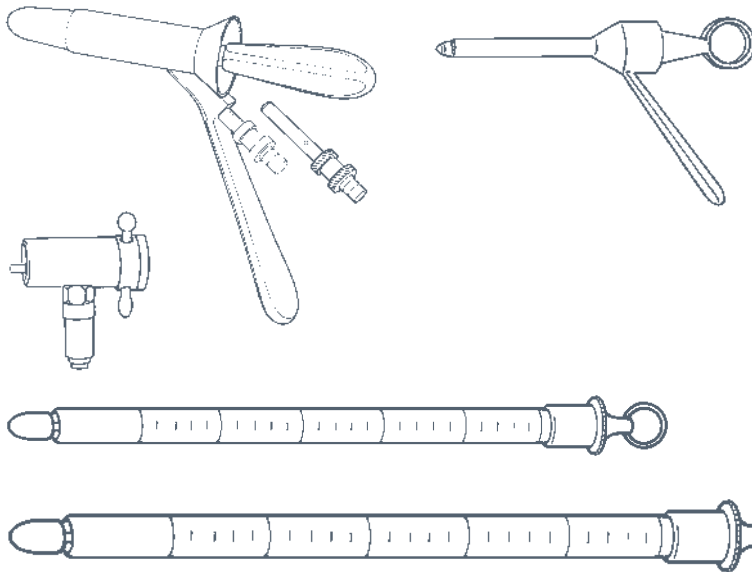

### Lloyd-Davies

major set, comprising adult sigmoidoscope with obturator, 300mm x 20mm, adolescent sigmoidoscope with obturator 250mm x 15mm, child proctoscope with obturator 10mm diameter, Naunton Morgan rectal speculum with obturator 20mm diameter with fibre light carriers and fibre optic illumination head unit  
**3935/50** complete in case



### Lloyd-Davies

set comprising 1 graduated tube with obturator, with fibre optic illumination head unit, complete in case

adolescent  
**3937/05** tube 250mm x 15mm



adult  
**3937/25** tube 300mm x 20mm

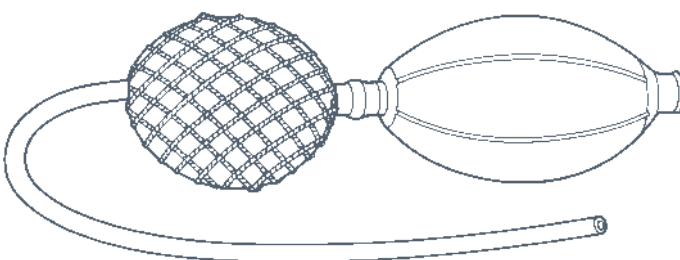

### Inflation Bellows

**3950/05** rubber, double

PRO



DENT





# CHISELS OSSEUS



**Coupland**

4001/01 fig 1



**Coupland**

4001/02 fig 2



**Coupland**

4001/03 fig 3

# ELEVATORS



**Periosteal**

4002/01 fig 1



**Periosteal**

4002/02 fig 9

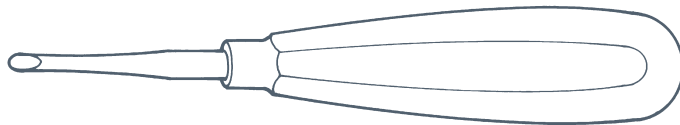

**Apical**

straight

4010/01 fig 26



left

4010/02 fig 27



right

4010/03 fig 28



DENT



# ELEVATORS

## Apical

4010/04 fig 34CD



4010/05 fig 34SCD



4010/06 fig 44CD



4010/07 fig 46CD



4010/08 fig 81CD



DENT

## Coleman

serrated

4010/09 fig 20

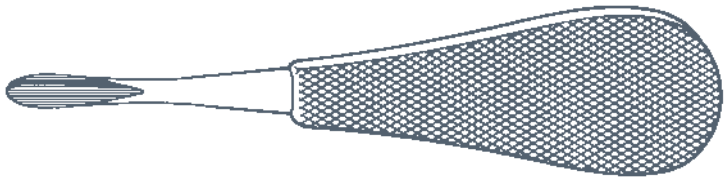

## Hospital

left

4010/12 fig21

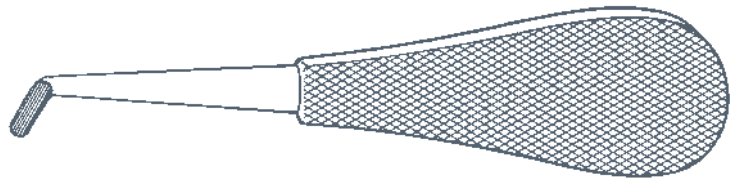

right

4010/13 fig22





ELEVATORS

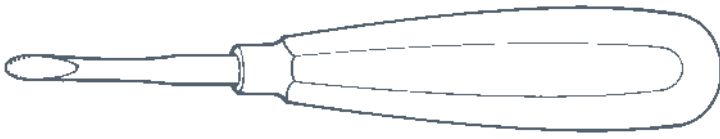

**Lindo Levien**

large  
4010/14 fig LLL



medium  
4010/15 fig LLM



small  
4010/16 fig LLS

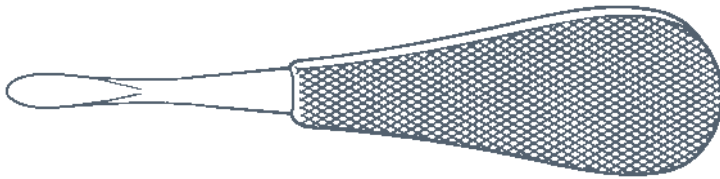

**Reads**

smooth  
4010/17 fig 19



**Warwick James**

4010/18 straight



4010/19 right



4010/20 left





# ELEVATORS

## Winters Root

4010/21 fig 1L



4010/22 fig 1R



4010/23 fig 12L



4010/24 fig 12R

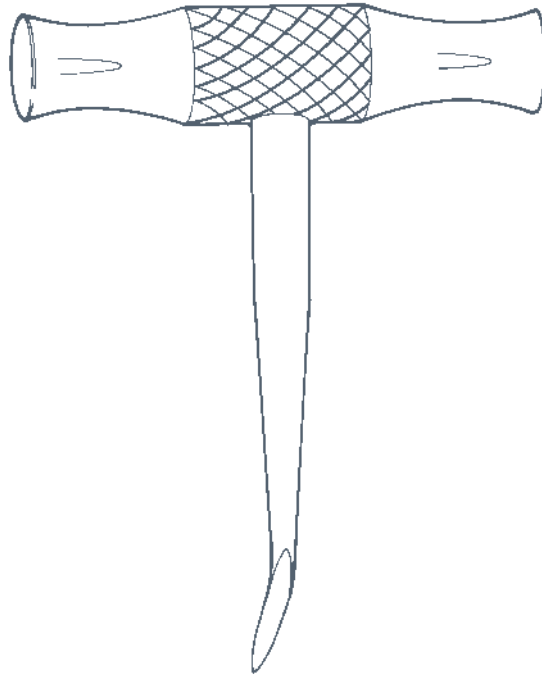

# EXOLEVERS

## Apical

straight fig 78CD  
4020/00

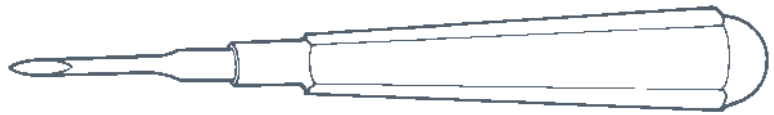

left fig 79CD  
4020/01



right fig 80CD  
4020/02

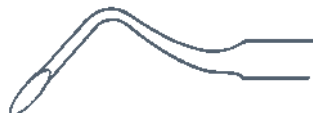

## Apical Clinic

straight fig 81  
4020/03

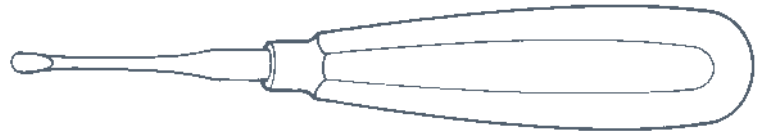

left fig 81  
4020/04



right fig 81  
4020/05

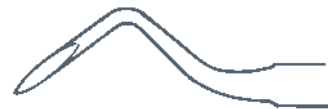

DENT



EXOLEVERS



Cryers

left fig 30  
4020/06



right fig 31  
4020/07

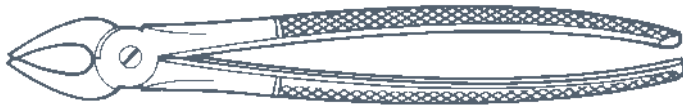

EXTRACTING FORCEPS

Upper Anteriors

4030/01 fig 1



4030/02 fig 2



4030/03 fig 29



4030/04 fig 29S



4030/05 fig 107



4030/06 fig 113 (Martin)



4030/07 fig 165



4030/09 fig 136H (Guys)

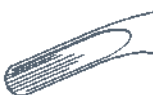

DENT



# EXTRACTING FORCEPS

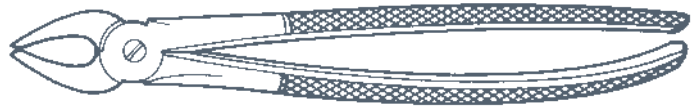

## Upper Premolars and Roots

4031/01 fig 7

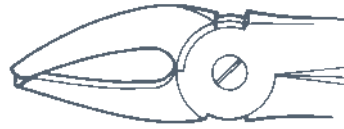

4031/02 fig 30



4031/07 fig 136 (Guys)



DENT

4031/03 fig 41

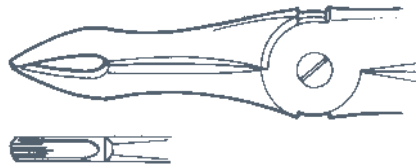

4031/08 fig 44N

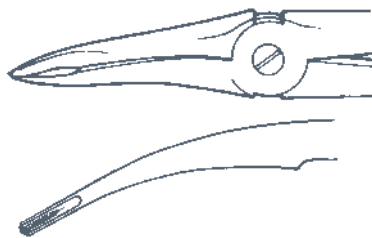

4031/04 fig 44S

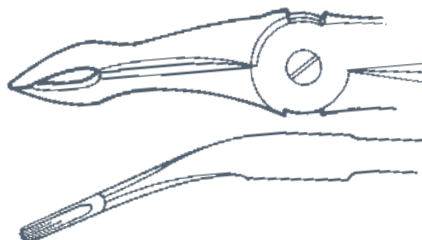



## EXTRACTING FORCEPS

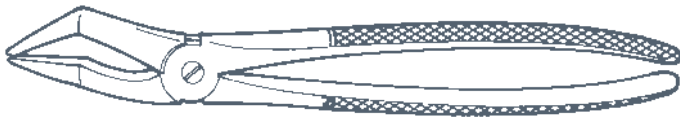

### Upper Roots



4032/00 fig 51



4032/01 fig 52



4032/11 fig 147 (Gibb)

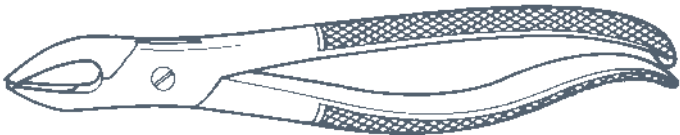

4032/02 fig 76



4032/03 fig 76H



4032/04 fig 76N



4032/05 fig 76S

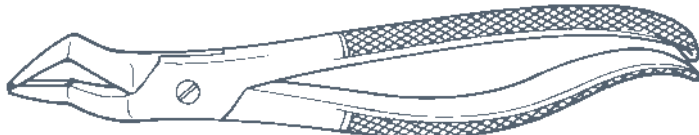

4032/09 fig 104 (Robin)



4032/07 fig 101



4032/08 fig 101A

DENT



# EXTRACTING FORCEPS

## Upper Roots

4032/15 fig 108 (Hill)

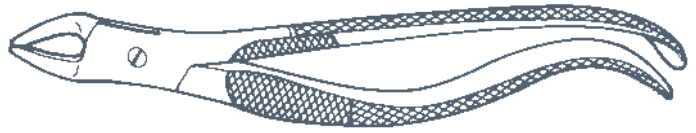

4032/10 fig 110 (Thorne)

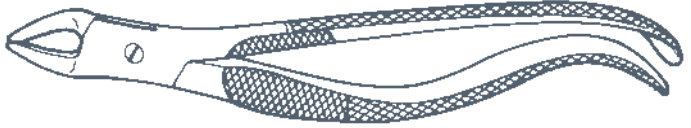

4032/12 fig 112 (Martin)

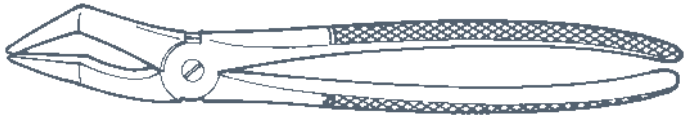

4032/16 fig 139



## Upper Molars

4033/01 fig 17



4033/02 fig 18







# EXTRACTING FORCEPS

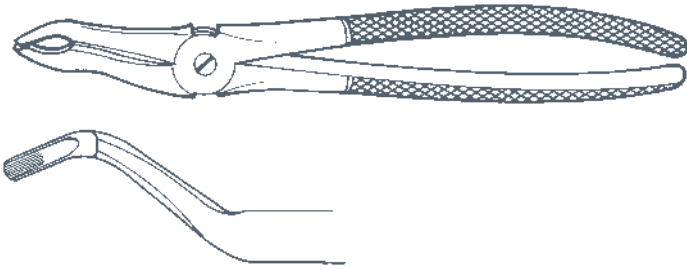

Upper Molars

4033/03 fig 88

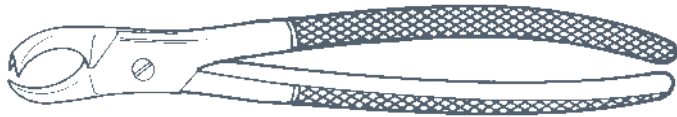

4033/04 fig 89



4033/05 fig 90

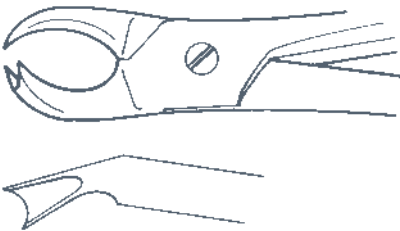

4033/06 fig 92

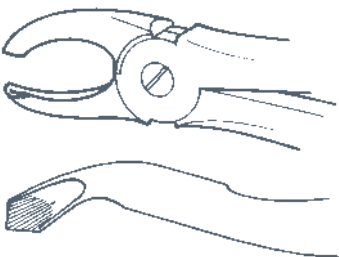

4033/07 fig 93



# EXTRACTING FORCEPS

## Upper Molars

4033/08 fig 94

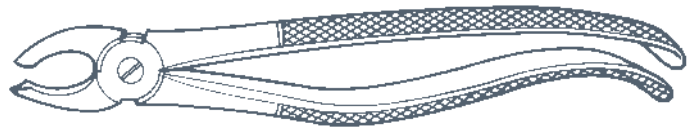

4033/09 fig 95

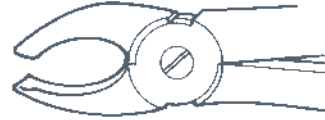

4033/10 fig 96



4033/11 fig 97



DENT

## Upper Wisdom and Roots

4034/01 fig 19

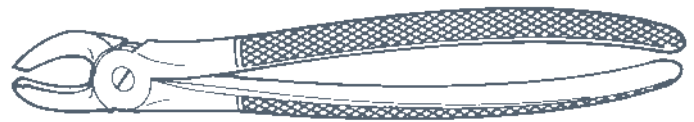

4034/02 fig 67

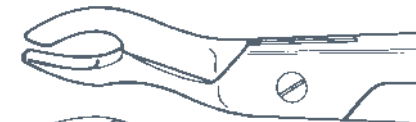



## EXTRACTING FORCEPS

### Lower Centrals and Roots

4035/02 fig 143 (Coleman)

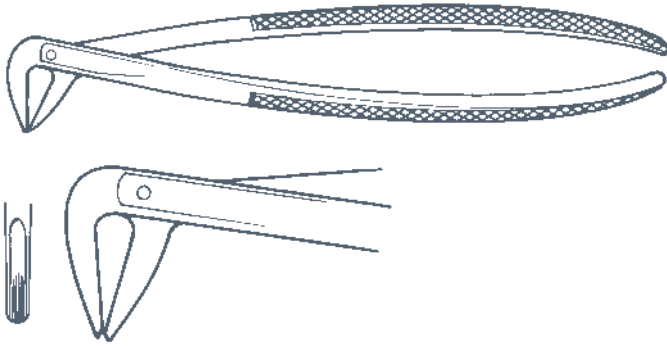

### Lower Incisors, Canines and Premolars

4036/05 fig 4

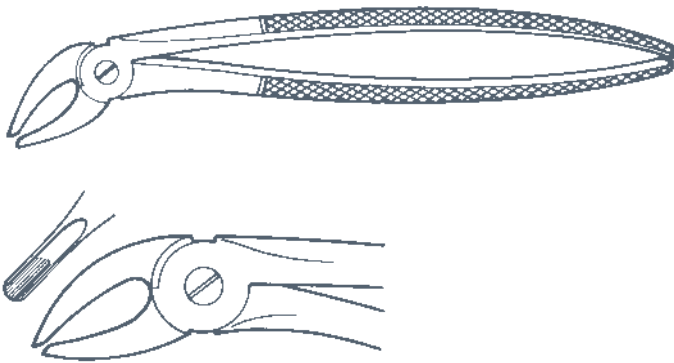

4036/02 fig 13

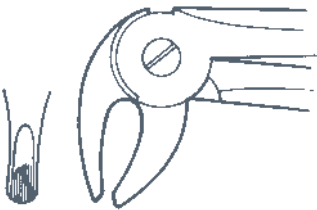

4036/03 fig 75

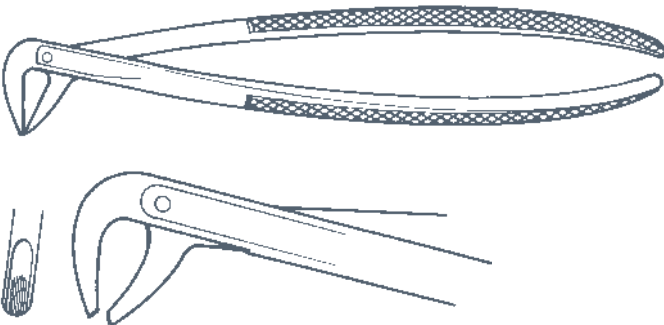

4036/04 fig 75A

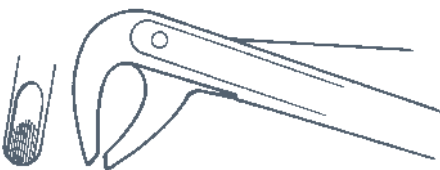



EXTRACTING FORCEPS

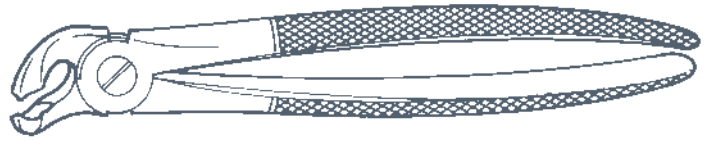

Lower Molars

4037/02 fig 22



4037/03 fig 23

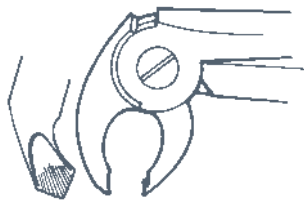

4037/04 fig 24

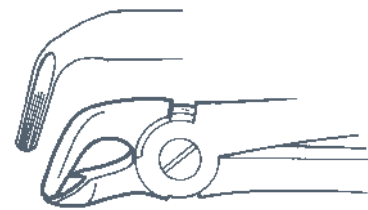

4037/05 fig 31

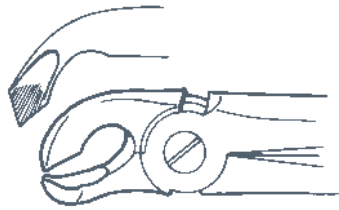

4037/06 fig 32

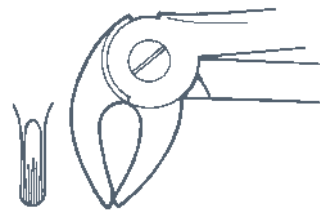

4037/07 fig 33

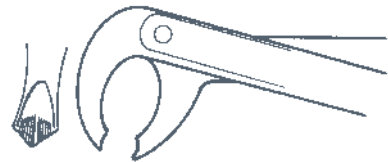
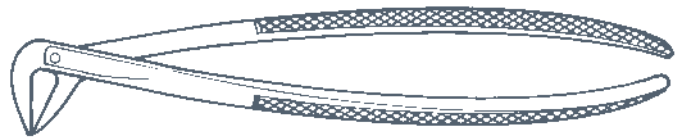

4037/09 fig 73

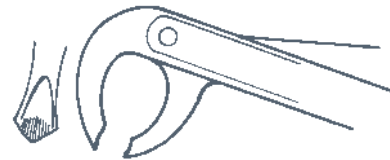

4037/10 fig 73L

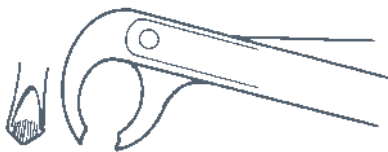

4037/11 fig 73S

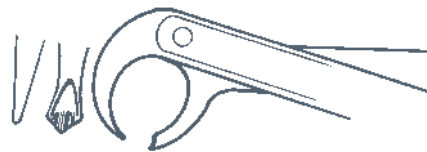

4037/12 fig 99 (Wood)

DENT



## EXTRACTING FORCEPS

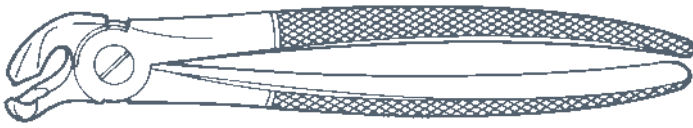

Lower Wisdoms and Molars

4038/01 fig 20

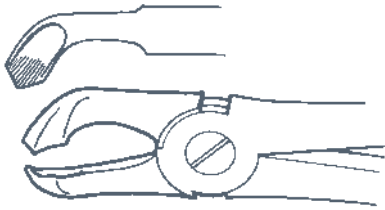
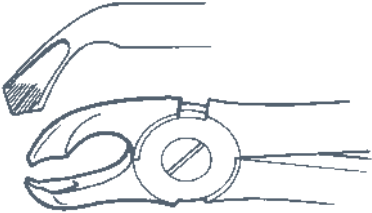

4038/02 fig 79

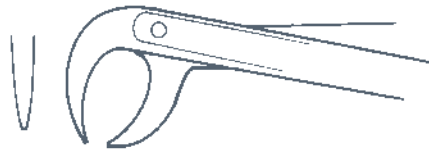

4038/03 fig 86

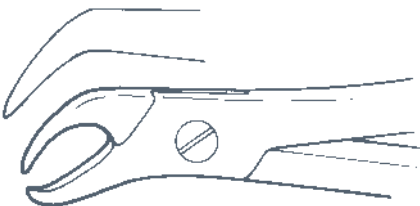
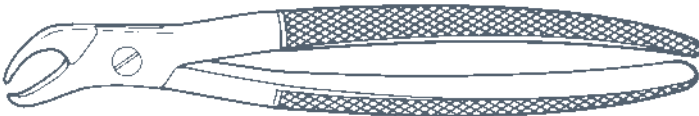

4038/04 fig 87



# EXTRACTING FORCEPS

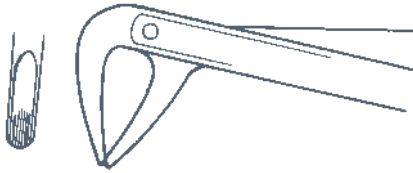

Lower Molars and Roots

4039/01 fig 74

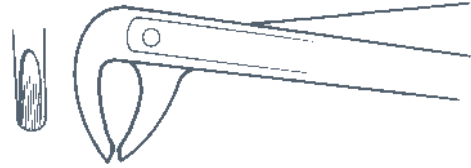

4039/02 fig 74D (Donagan)

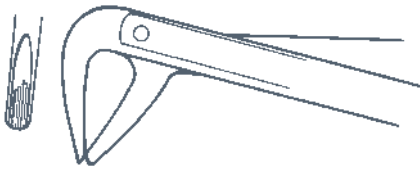

4039/03 fig 74M

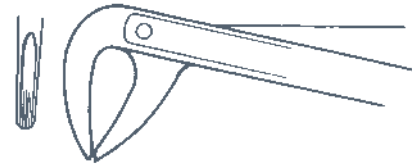

4039/04 fig 74N

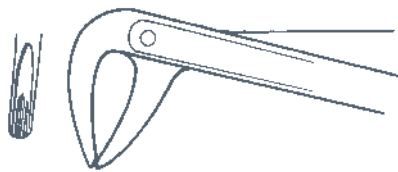

4039/06 fig 114 (Martin)

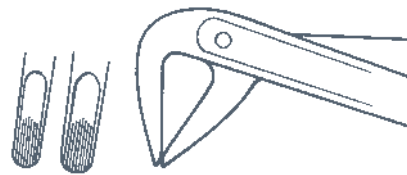

4039/08 fig 137 (Guys)

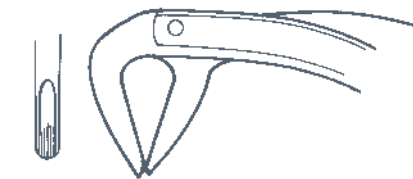

4039/10 fig 144 (Balding)

DENT



# EXTRACTING FORCEPS

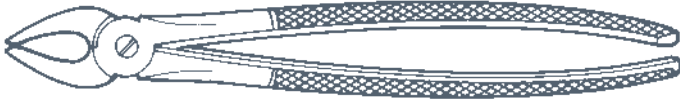

## Children's Patterns



4040/01 fig 37

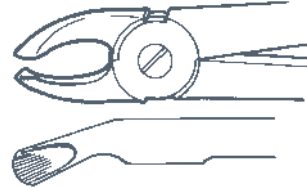

4040/02 fig 39

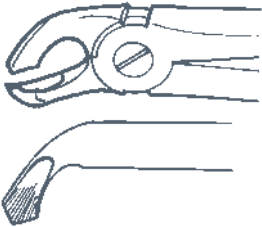

4040/07 fig 40

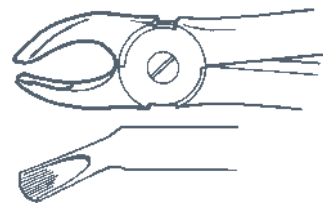

4040/09 fig 157

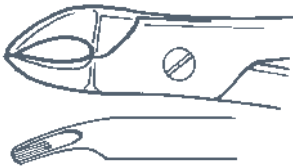

4040/08 fig 138



4040/11 fig 158

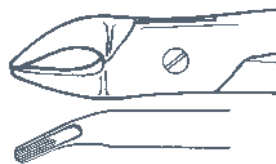

4040/12 fig 159

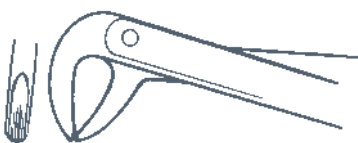
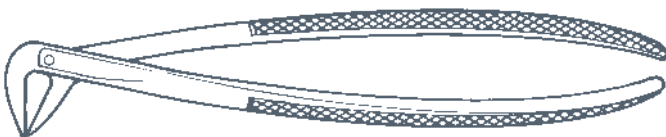

4040/03 fig 123

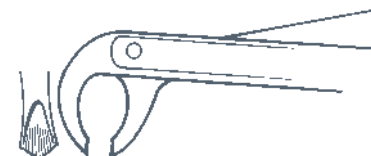

4040/04 fig 160

DENT



# EXTRACTING FORCEPS

## Children's Patterns

4040/05 fig 162

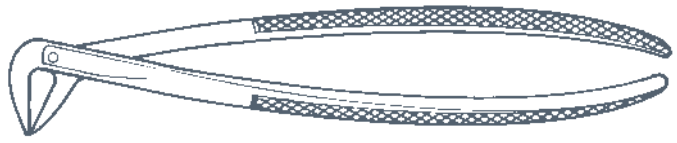

4040/14 fig 161

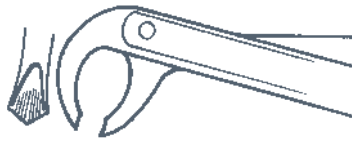

4040/06 fig 163

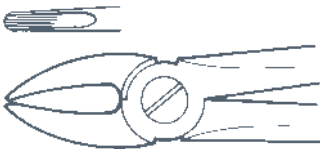

## Rongeurs

4043/01 fig 3

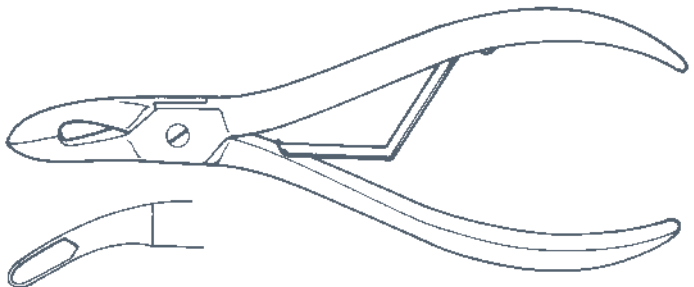

4043/02 fig 4

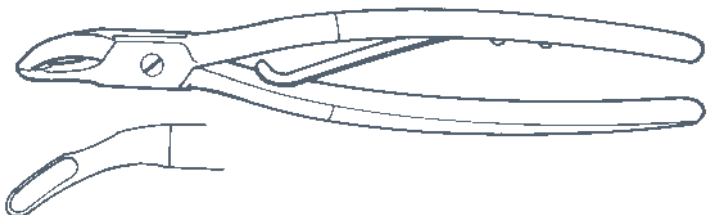





# HAND INSTRUMENTS

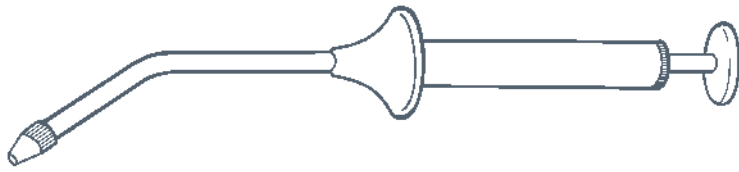

**Amalgam Carrier**

stainless steel  
4047/01 fig 5X



**Amalgam**

double ended  
4048/01 fig G

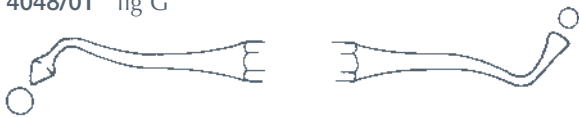

double ended  
4048/02 fig H

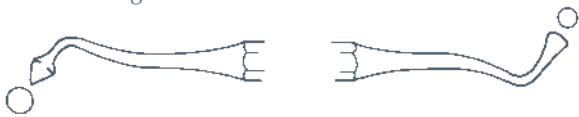

double ended  
4048/03 fig J



double ended  
4048/04 fig O



double ended  
4048/05 fig P



double ended  
4048/06 fig Q



double ended  
4048/07 fig R

**Condenser**

wards, double ended  
4049/01 fig 1

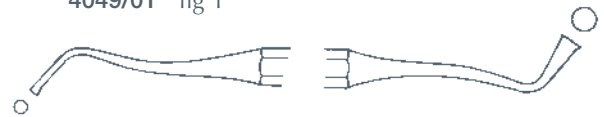

wards, double ended  
4049/02 fig 2



**Plugger**

double ended  
4050/01 fig 0/1  
4050/02 fig 1/2



**Burnisher**

double ended, American pattern  
4051/01 fig 1



double ended, American pattern  
4051/02 fig 1L

DENT



# HAND INSTRUMENTS

## Carver

double ended  
4052/01 fig AF34

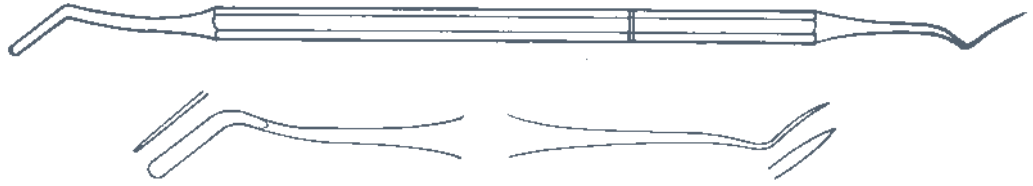

## Carver

double ended  
4052/02 fig 5T

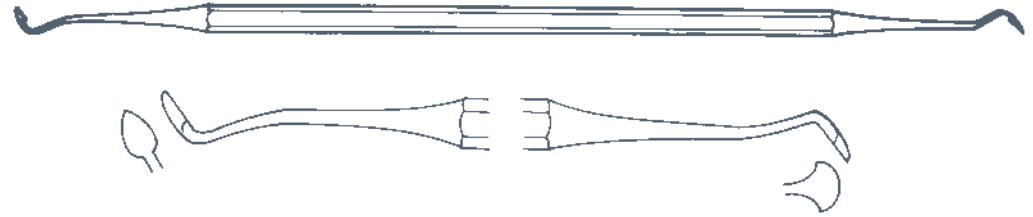

## Clappison

4052/03 fig 4



## Frahm

4052/04 fig 90° R and L



## Hollenbach

4052/05 fig 3  
4052/06 fig 3½



## Hollenbach

4052/07 fig 5



## Carver

Le Cron  
4052/08 double ended



## Osteo Mitchell

4052/09 fig 4



## Wards

4052/10 fig 1



DENT



HAND INSTRUMENTS

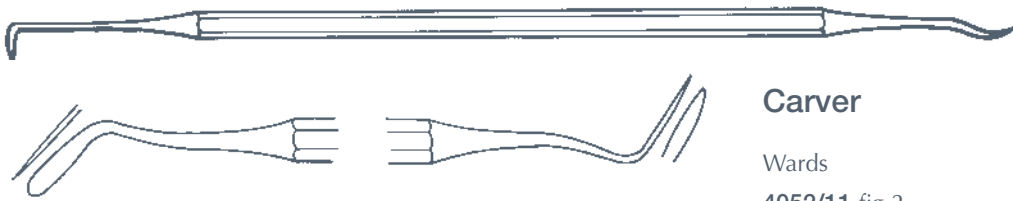

**Carver**

Wards  
4052/11 fig 2



Wax carver and spatula  
4052/13 fig 5



**Blacks**



hoe, single end  
4053/03 fig 28



hoe, single end  
4053/04 fig 29



hoe, single end  
4053/05 fig 34



hoe, single end  
4053/06 fig 35



enamel hatchet, single end  
4054/01 fig 49



4054/02 fig 50



enamel hatchet, single end  
4054/03 fig 51



4054/04 fig 52



enamel hatchet, single end  
4054/05 fig 53



4054/06 fig 54

bin angle chisel, single end  
4055/01 fig 81

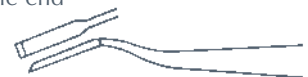

bin angle chisel, single end  
4055/02 fig 82

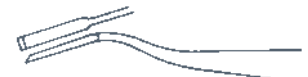

bin angle chisel, single end  
4055/03 fig 82R



bin angle chisel, single end  
4055/04 fig 83



straight chisel, single end  
4056/01 fig 84



4056/02 fig 85



4056/03 fig 86



side hatchet, single end  
4057/01 fig 88



DENT



# HAND INSTRUMENTS



## Blacks

enamel hatchet, double ended  
4058/01 fig 51/52



enamel hatchet, double ended  
4058/02 fig 53/54



gingival margin trimmer, double ended  
4059/01 fig 77/78



gingival margin trimmer, double ended  
4059/02 fig 79/80



gingival margin trimmer, double ended  
4059/03 fig U1/U2

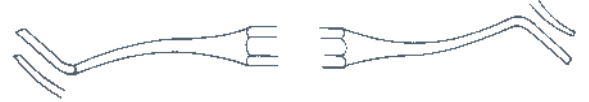

gingival margin trimmer, double ended  
4059/04 fig U3/U4

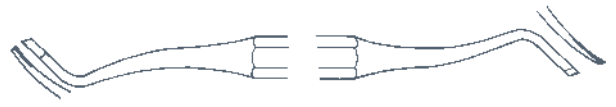

gingival margin trimmer, double ended, tungsten carbide  
4060/01 fig TC77/78



gingival margin trimmer, double ended, tungsten carbide  
4060/02 fig TC79/80

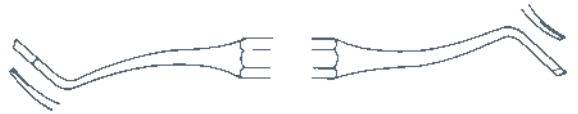

gingival margin trimmer, double ended, tungsten carbide  
4060/03 fig TCU1/U2

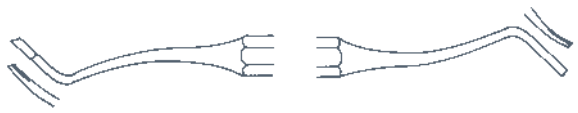

gingival margin trimmer, double ended, tungsten carbide  
4060/04 fig TCU3/U4



## Excavator



4065/01 fig 73/74

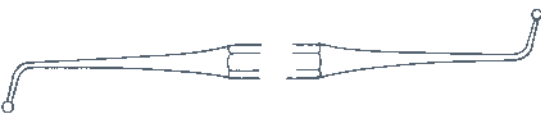

4065/02 fig 119/20

4065/03 fig 121/22

4065/04 fig 123/24



4065/05 fig 125/26



4065/06 fig 127/28



4065/07 fig 129/30



# HAND INSTRUMENTS

DENT



## Excavator



4065/08 fig 131/32



4065/09 fig 133/34



4065/10 fig 153/54

4065/11 fig 155/56

4065/12 fig 157/58



4065/13 fig 243



4065/14 fig 244



4065/15 fig 245



4065/16 fig 246



4065/17 fig 204/5



4065/18 fig 210/11



4065/19 fig 220/21



4065/20 fig G2



4065/21 fig G4



## Plastics

4067/01 fig 1



4067/02 fig 1A



4067/03 fig 1S



4067/04 fig 2



4067/05 fig 3

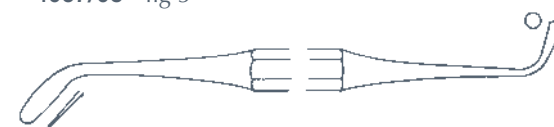

4067/06 fig 4

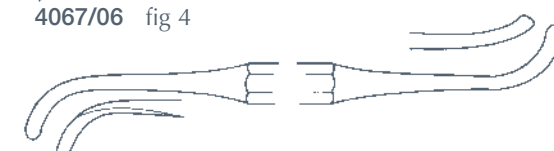

4067/07 fig 5



4067/08 fig 6



# HAND INSTRUMENTS



## Plastics



4067/09 fig 6SH

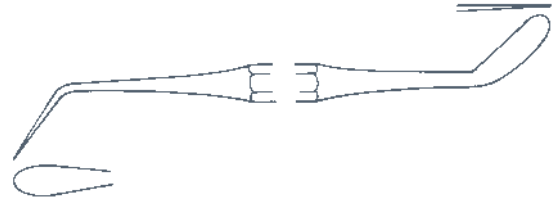

4067/17 fig 22 (Wallis)

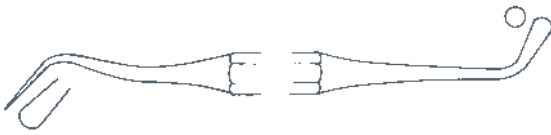

4067/10 fig 7

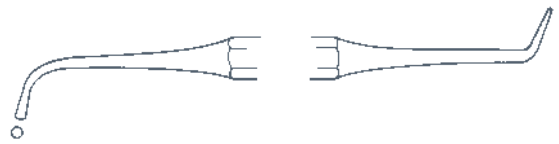

4067/18 fig 49 (Baldwin)



4067/11 fig 11 (Ladmore)

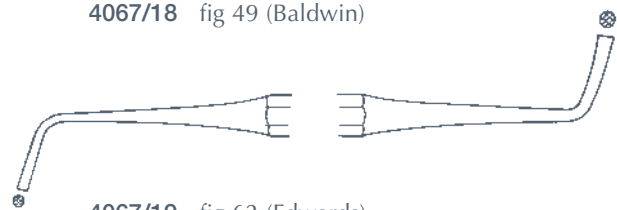

4067/19 fig 62 (Edwards)

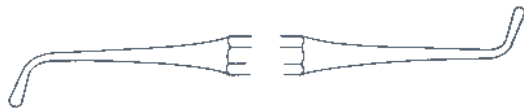

4067/12 fig 12 (Ladmore)



4067/20 fig 63 (Edwards)

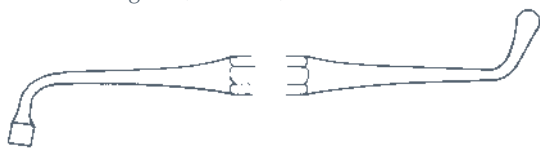

4067/13 fig 16 (Ladmore)



4067/21 fig 151

4067/22 fig 151SM



4067/14 fig 18 (Wallis)



4067/23 fig 153

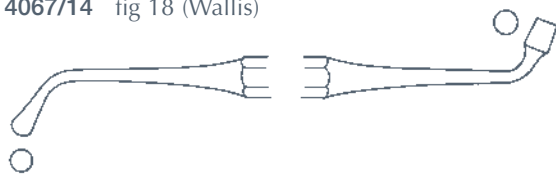

4067/15 fig 20 (Wallis)



4067/24 fig 153A

4067/25 fig 153SM



4067/16 fig 21 (Wallis)

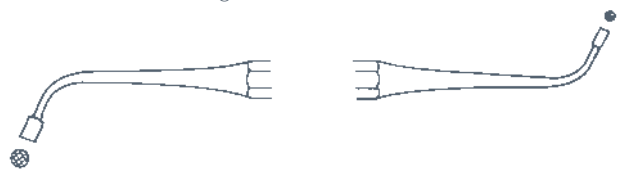

4067/26 fig 154

4067/27 fig 154S

DENT



HAND INSTRUMENTS



Plastics



4067/28 fig 155 (Hopson)



4067/36 fig 183



4067/29 fig 156 (Hopson)

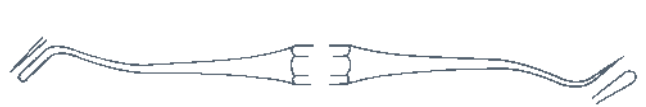

4067/37 fig 185



4067/30 fig 166



4067/38 fig 187



4067/31 fig 178



4067/39 fig 190



4067/32 fig 179



4067/40 fig PF10



4067/33 fig 180

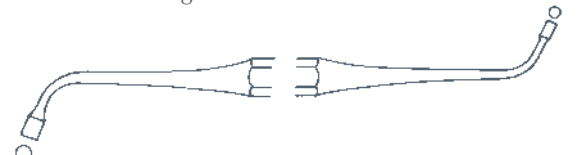

4067/43 fig G (Guys)



4067/34 fig 181

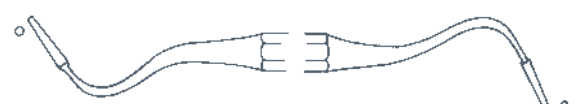

4067/44 fig MOR2 (Mortonson)



4067/35 fig 182

DENT



# HAND INSTRUMENTS

## Probe

4068/01 fig 1



4068/02 fig 2



4068/03 fig 5AM (Explorer)

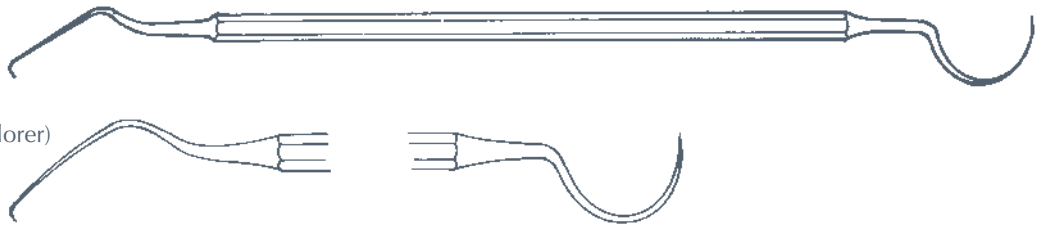

4068/04 fig 6



4068/05 fig 8



4068/06 fig 9



4068/07 fig 11 (Briault)

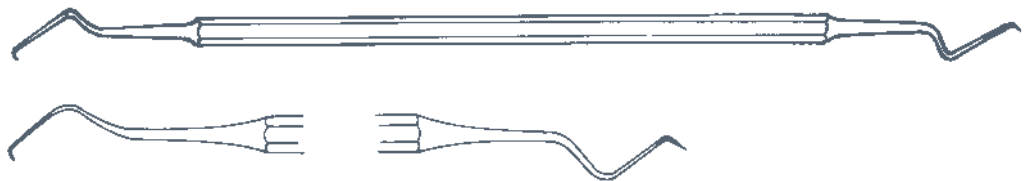

4068/08 fig 13

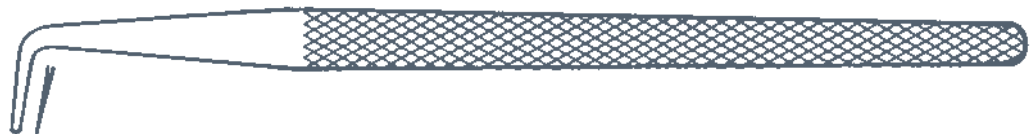

DENT





HAND INSTRUMENTS



Probe

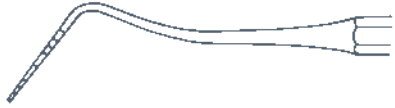

4068/09 fig 14W (Pocket Measuring)



4068/10 fig 37



4068/11 fig 48



4068/12 fig 49



4068/13 fig 54

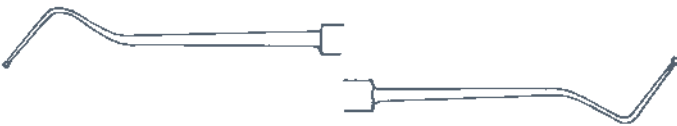

4068/14 Cross Calculus



4068/15 Holst



4068/16 Holst A



4068/17 fig 5/6

DENT



# HAND INSTRUMENTS

## Probe, Finetine

4068/20 fig FT6



4068/21 fig FT8



4068/22 fig FT9



4068/23 fig FT54



4068/24 fig FT5/8

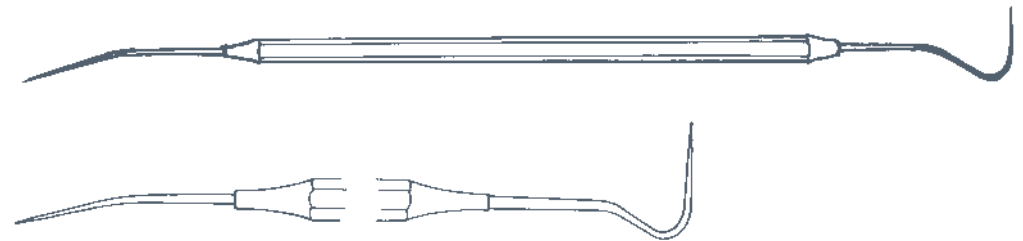

4068/25 fig FT8/9

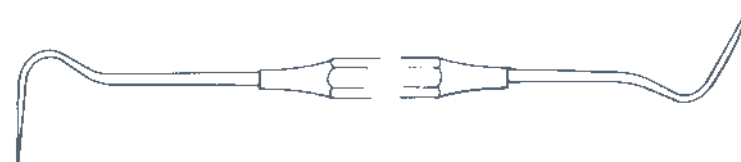

4068/26 fig FT5

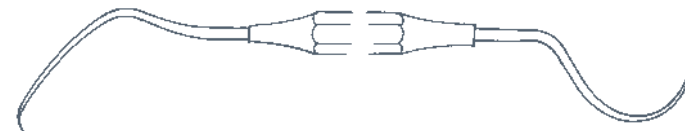

4068/27 fig FT11 (Briault)



4068/28 fig FT12 (Weston)



DENT



HAND INSTRUMENTS



Scalers

Curette, single end  
4069/01 fig 2L



Curette, single end  
4069/02 fig 2R

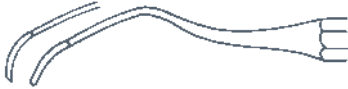

Curette, single end  
4069/03 fig 4L

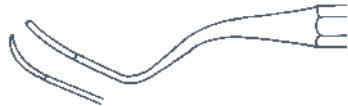

Curette, single end  
4069/04 fig 4R

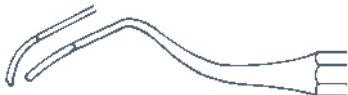

Curette, single end  
4069/05 fig 13

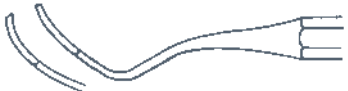

Curette, single end  
4069/06 fig 14

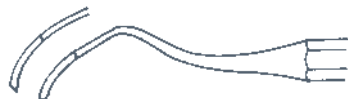

Darby Perry, single end  
4069/07 fig 111



Darby Perry, single end  
4069/08 fig 121



Guys, single end  
4069/09 fig G1



Guys, single end  
4069/10 fig G2



Guys, single end  
4069/11 fig G3



Guys, single end  
4069/12 fig G4



Howe, single end  
4069/13 fig 65



Guys, single end  
4069/14 fig 66

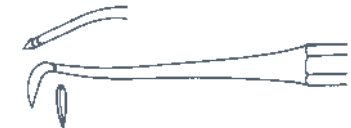

Howe, single end  
4069/15 fig 67



Hygienist, single end  
4069/16 fig H3



Hygienist, single end  
4069/17 fig H4



DENT



## HAND INSTRUMENTS

### Scalers



Hygienist, single end  
4069/18 fig H5



Nilsen, single end  
4069/27 fig 195A



Hygienist, single end  
4069/19 fig H6



Peridontal Hoe,  
single end  
4069/28 fig 4C

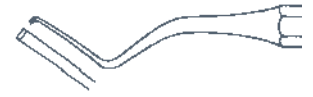

Hygienist, single end  
4069/20 fig H7



Peridontal Hoe,  
single end  
4069/29 fig 7C

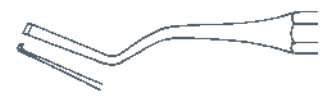

Hygienist, single end  
4069/21 fig H8



Peridontal Hoe,  
single end  
4069/30 fig 8C

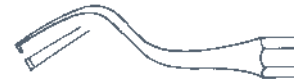

Hygienist, single end  
4069/22 fig H9



Peridontal Hoe,  
single end  
4069/31 fig 9C

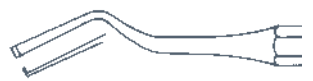

Jaquettes, single end  
4069/23 fig 1



Towner, single end  
4069/32 fig U15



Jaquettes, single end  
4069/24 fig 2



Williams, single end  
4069/33 fig 42



Jaquettes, single end  
4069/25 fig 3



Younger Good,  
single end  
4069/34 fig 72



Nilsens, single end  
4069/26 fig 195



Younger Good,  
single end  
4069/35 fig 73





HAND INSTRUMENTS



**Scalers**

Cumine, double ended  
4071/01 fig 152

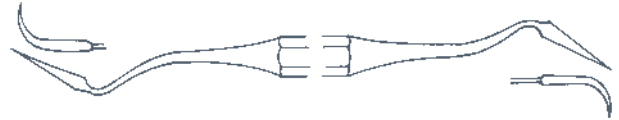

Scaler, double ended  
4071/04 fig 6AF



Cumine, double ended  
4071/02 fig 152A



Shepherd, double ended  
4071/05 fig 197



Probe/Scaler, double ended  
4071/03 fig 4



Shepherd, double ended  
4071/06 fig 198



**Spatulas**

Weston  
4073/01 fig 3



double ended  
4073/02 fig 8

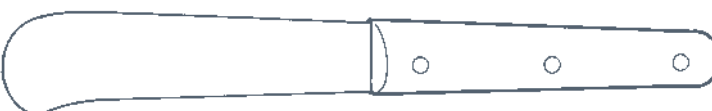

plaster mixer  
4073/03 fig 8X

DENT



# DENTAL FILES

## Millers

double ended  
4062/01 fig 52



# DENTAL KNIVES

## Blakes Universal

4063/01 balanced grip

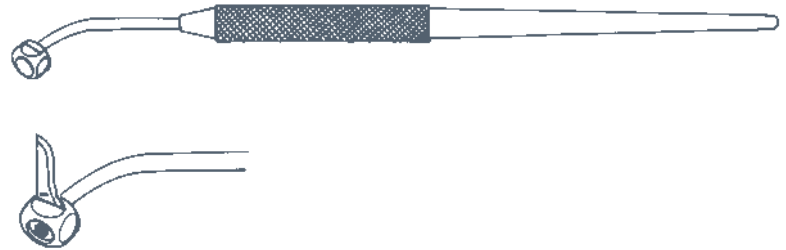

## Plaster

4106/29 wood handle



## Wax

wood handle  
4052/14 large  
4052/15 small



# DENTAL MIRRORS

## Plain

stainless steel mount, rear surface

- 4066/01 size 3, 20mm
- 4066/02 size 4, 22mm
- 4066/03 size 5, 24mm
- 4066/04 size 6, 26mm

stainless steel mount, front surface

- 4066/20 size 4, 22mm
- 4066/21 size 5, 24mm

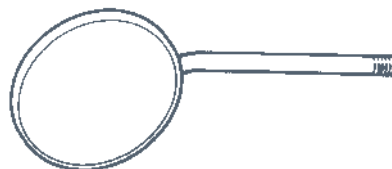



## DENTAL MIRRORS

### Handle



stainless steel, round  
4066/25 smooth



stainless steel  
4066/26 serrated

## DENTAL PLIERS

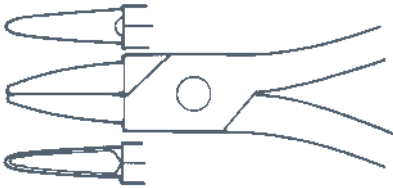
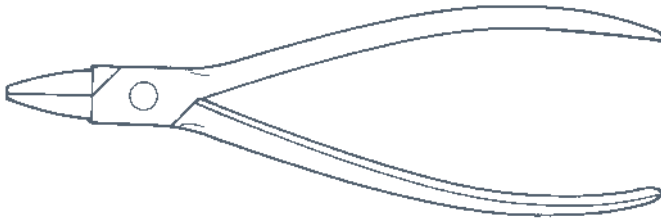

### Marthew

plate  
4080/01 fig 26

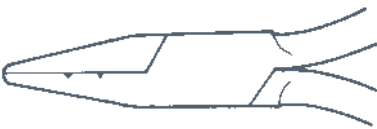

### Schroeder

pointed  
4080/02 fig 42M



### Universal

wire bending  
4080/03 fig 57

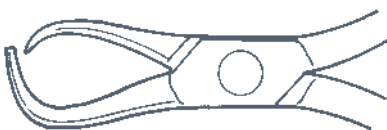

### Pullen

band removing  
4080/04 fig 58



# DENTAL PLIERS

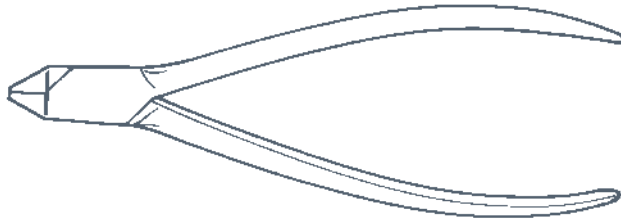

## Adams

universal wire bending, tungsten carbide  
4080/07 fig 64TC

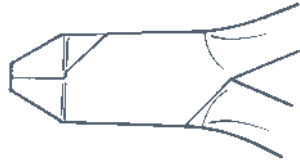

## Johnson

contouring  
4080/13 fig 114



## Adams

arch and spring bending, tungsten carbide  
4080/09 fig 65TC

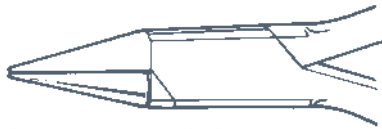

## Ligature Cutters

4080/16 fig 150M

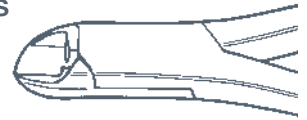

## Flat Nose

4080/11 fig 102M

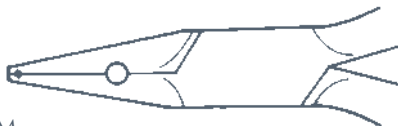

## Band Removing

anterior  
4080/17 fig 345

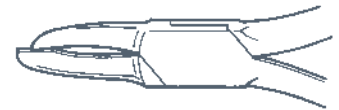

posterior  
4080/18 fig 347



## Howe

4080/12 fig 110

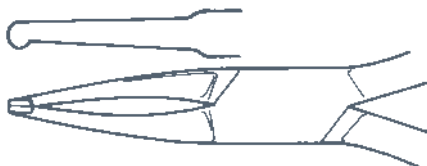

DENT





DENTAL SCISSORS

**Gum**

open shank, straight 115mm  
4082/01 fig 1



open shank, curved 115mm  
4082/02 fig 2

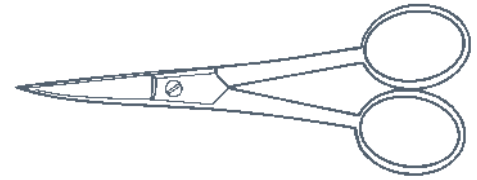

**Gum**

closed shank, straight 115mm  
4082/04 fig 4



closed shank, curved 115mm  
4082/05 fig 5

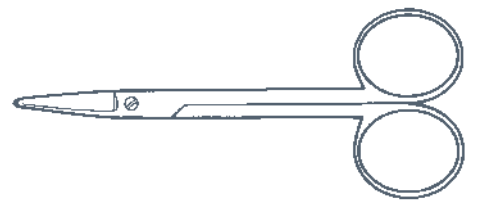

**Crown and Collar**

Bee Bee, curved, 110mm  
4082/09 fig 9



Bee Bee, straight, 110mm  
4082/12 fig 12

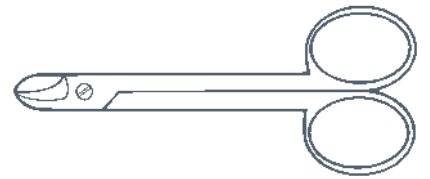

**Students**

150mm  
4082/13 fig 13

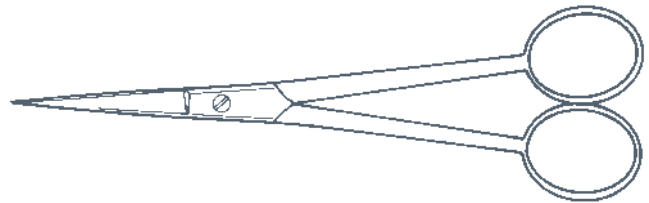

**Dressing**

125mm  
4082/14 fig 14

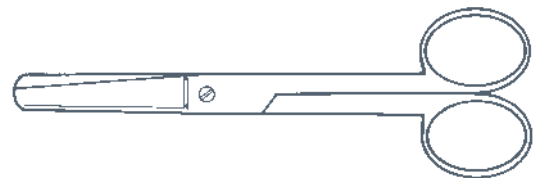

**Surgical**

115mm  
4082/19 fig 19





## DENTAL TWEEZERS

### Perry Dressing

125mm

4083/01 fig 6



### College Dressing

plain jaws, 150mm

4083/02 fig 8

serrated, 150mm

4083/03 fig 8S



### Plugging

150mm

4083/04 fig 11



### Guttman

160mm

4083/05 fig 13



### Dressing

160mm

4083/06 fig 17S



### Furnace

4083/07 200mm

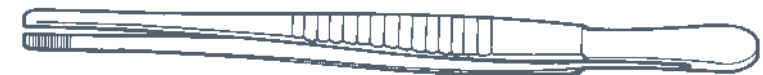

### Self-Locking

4083/08 160mm





## MATRIX CLAMP

### Siqveland

complete with 12 stainless steel bands

4110/01 wide

4110/11 narrow

spare bands, pack of 12

4110/02 wide

4110/12 narrow



## DENTAL SYRINGES

### Chip

4102/48 No 2

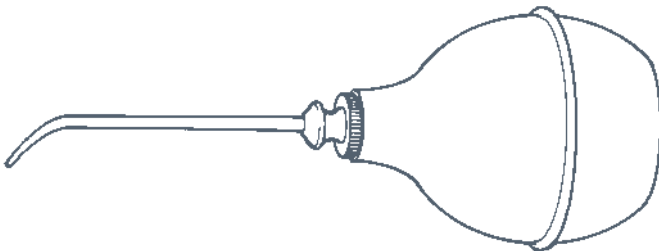

### Cartridge

4111/01 1.8cc

4111/11 2.2cc

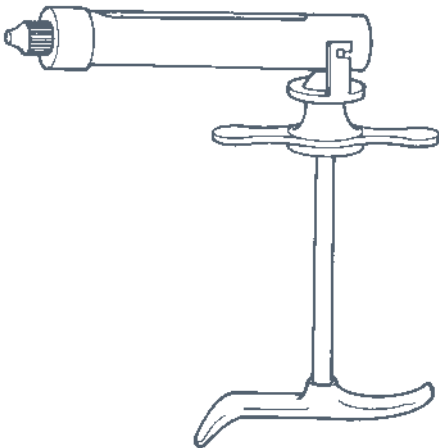

### Aspirating

4111/02 1.8cc

4111/12 2.2cc

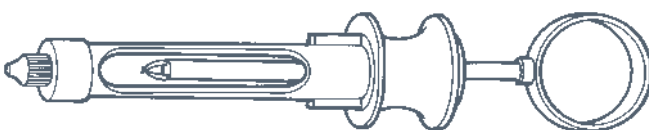



CHIR

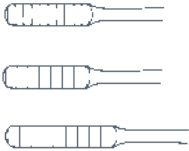

## CHIROPODY INSTRUMENTS

**Blacks File**

5001/00 fine

5001/01 medium

5001/02 tungsten carbide

**Probe, Swan Neck**

5002/01 flat, medium

5002/02 flat, small

5002/03 cupped

**Beaver Blade Holder**

5003/01 hexagonal



5003/02 round

**Nail Chisel**

stainless steel



5005/01



## CHIROPODY KNIVES



5004/03 fig 49

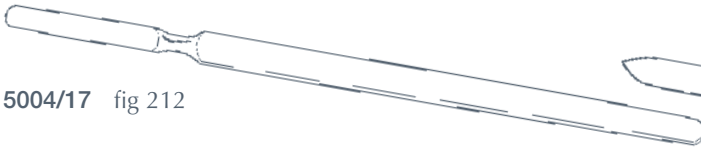

5004/17 fig 212

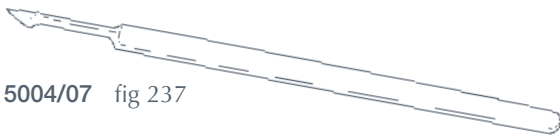

5004/07 fig 237

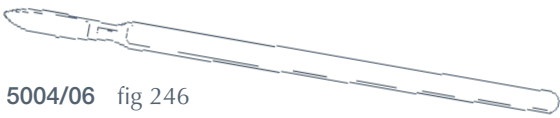

5004/06 fig 246



5004/15 fig 249

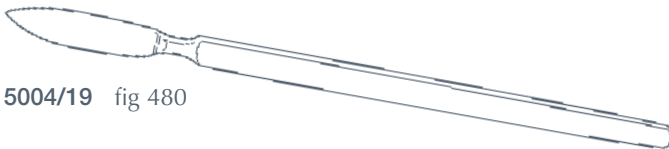

5004/19 fig 480

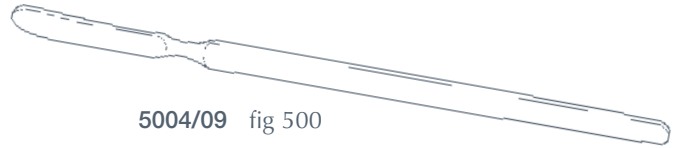

5004/09 fig 500



5004/18 fig 221

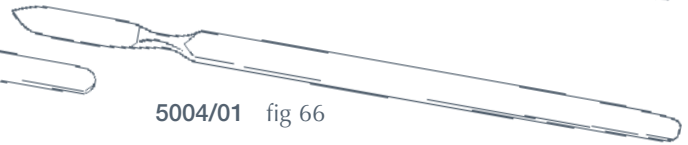

5004/01 fig 66

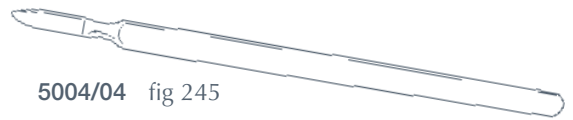

5004/04 fig 245

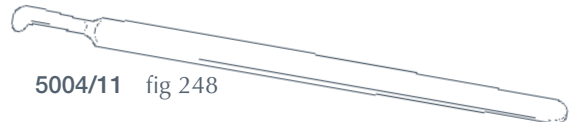

5004/11 fig 248



5004/52 fig 414

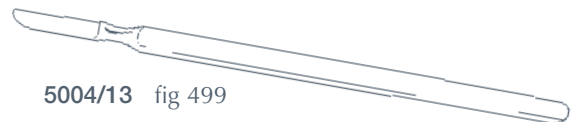

5004/13 fig 499

CHIR

## NIPPERS

### Concave

stainless steel with catch

5006/01 140mm



stainless steel without catch

5006/02 140mm

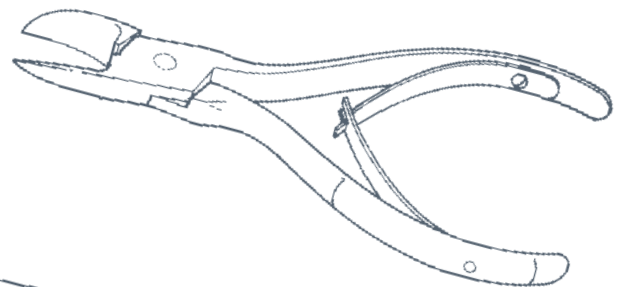

### Flat

stainless steel with catch

5007/01 140mm



stainless steel without catch

5007/02 140mm

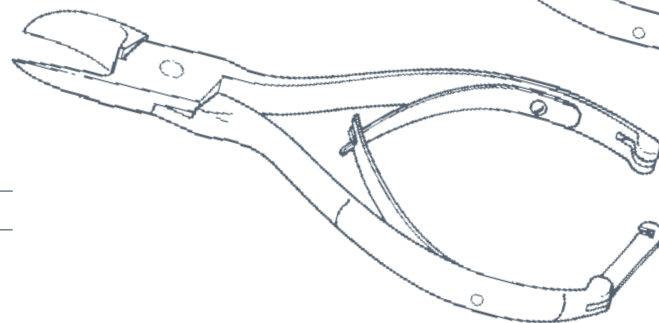



## NIPPERS

### Thwaites

for ingrowing nails

5008/01 130mm

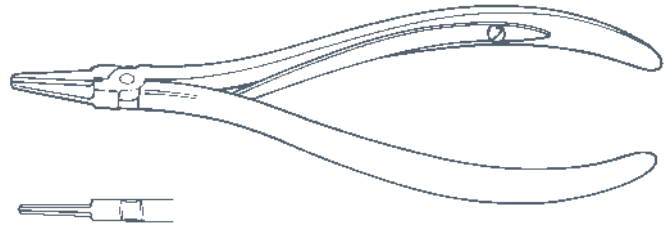

## SURGICAL SCISSORS

### Chiropody

short strong blades specifically designed to cut felt with ease

straight, blunt/blunt

5042/20 150mm

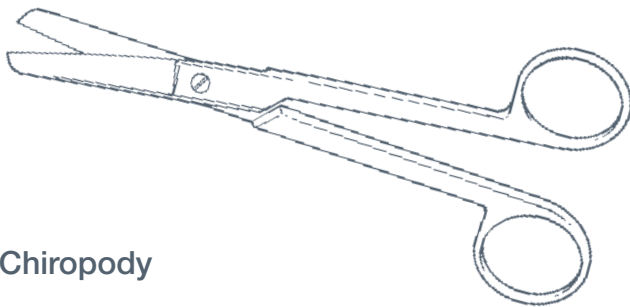

straight, blunt/sharp

5043/20 150mm

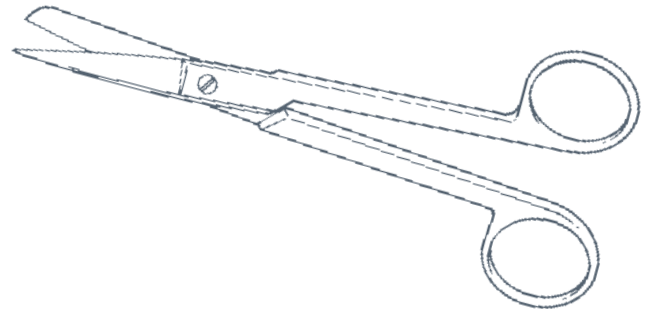

straight, sharp/sharp

5044/20 150mm

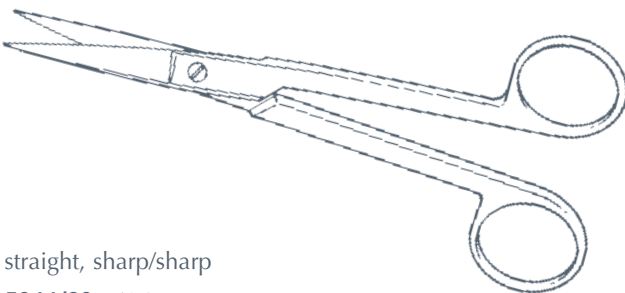

curved, blunt/blunt

5045/20 150mm

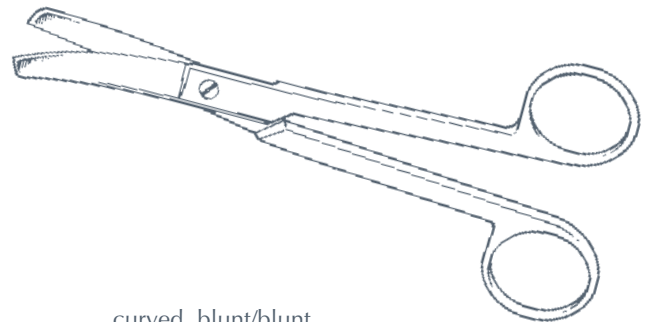

### Chiropody

curved, blunt/sharp

5046/20 150mm

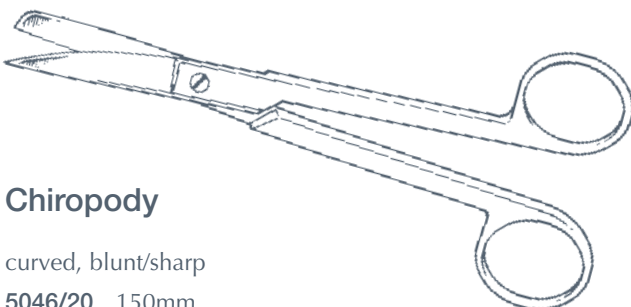

curved, sharp/sharp

5047/20 150mm

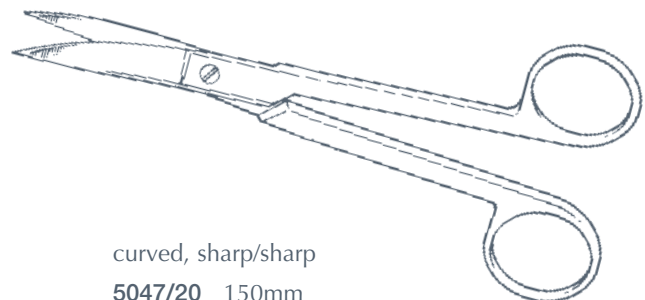



NEU





ARTERY FORCEPS

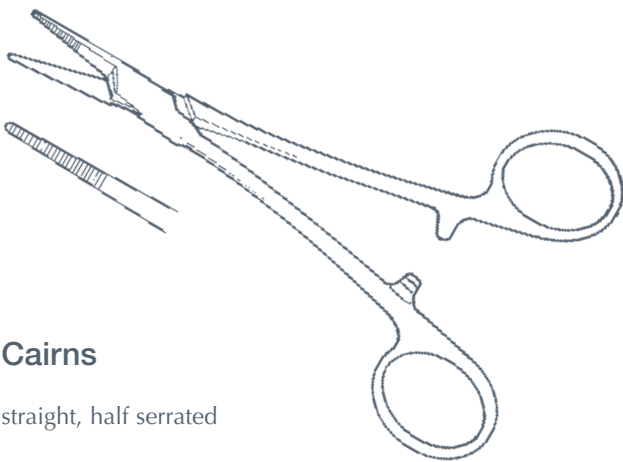

**Cairns**

straight, half serrated

5105/05 145mm

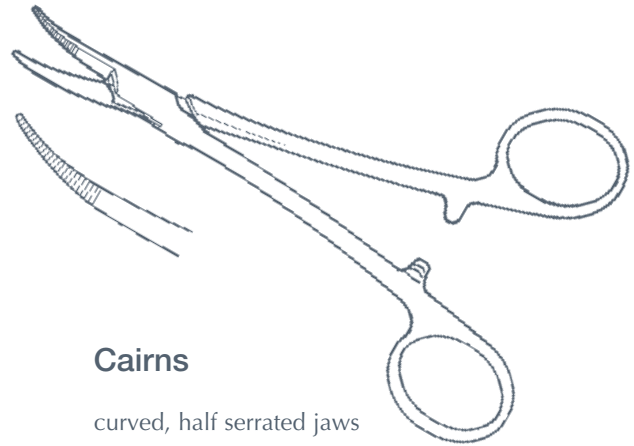

**Cairns**

curved, half serrated jaws

5106/05 145mm

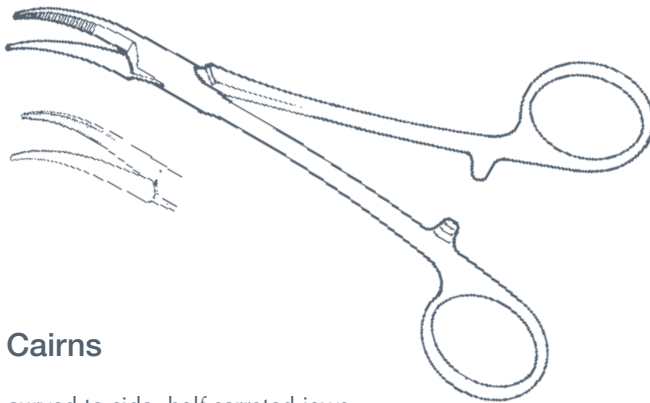

**Cairns**

curved to side, half serrated jaws

5107/05 145mm

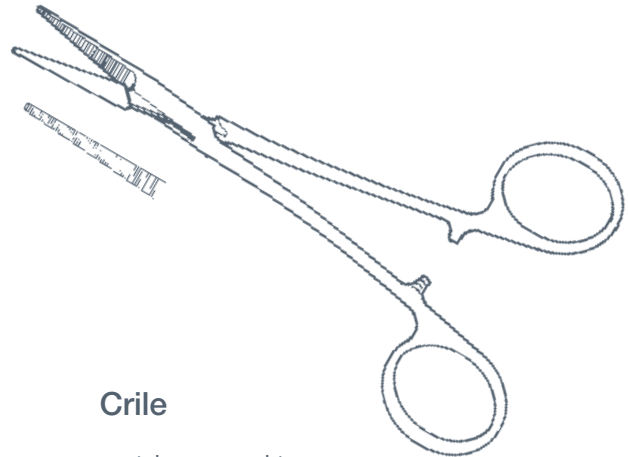

**Crile**

straight, serrated jaws

5115/05 140mm

5115/10 160mm

5115/15 180mm

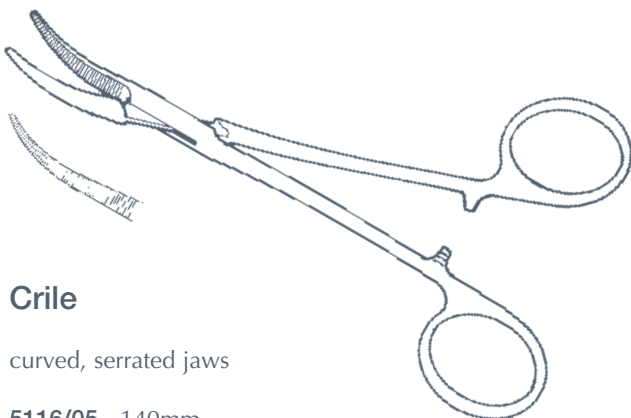

**Crile**

curved, serrated jaws

5116/05 140mm

5116/10 160mm

5116/15 180mm

NEU



## ARTERY FORCEPS

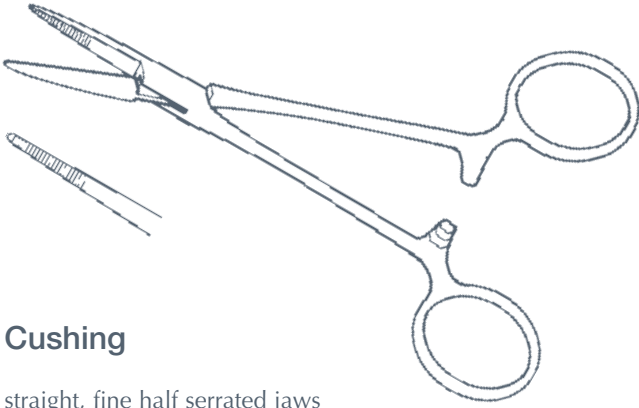

### Cushing

straight, fine half serrated jaws

5125/05 145mm

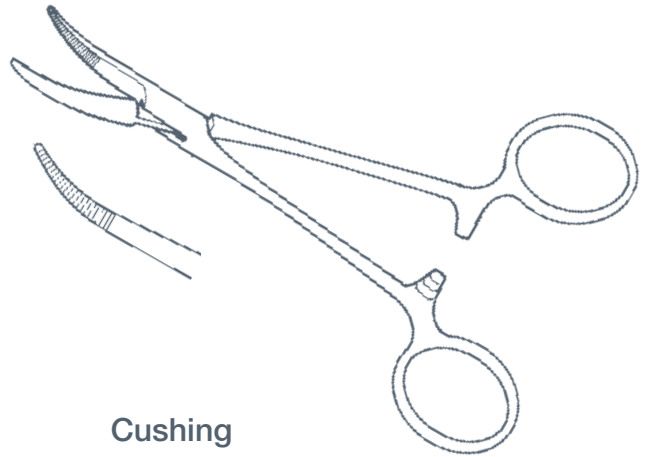

### Cushing

curved, fine half serrated jaws

5126/05 145mm

### Cushing

curved to side, fine half serrated jaws

5127/05 145mm

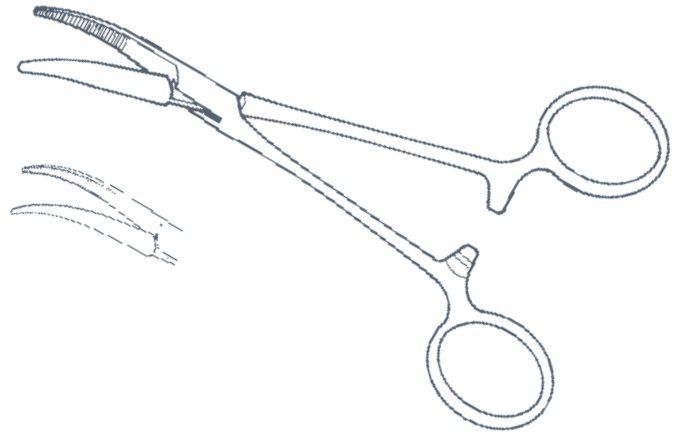

NEU

## BRACE

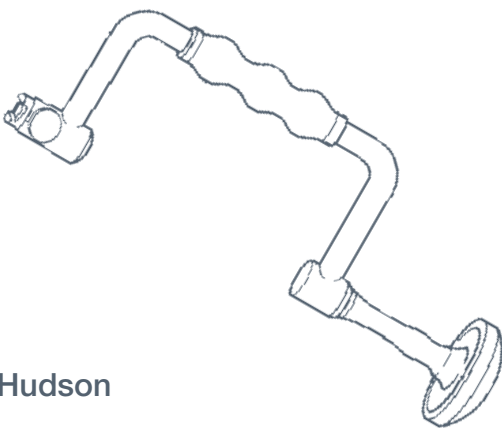

### Hudson

5135/05 universal fitting

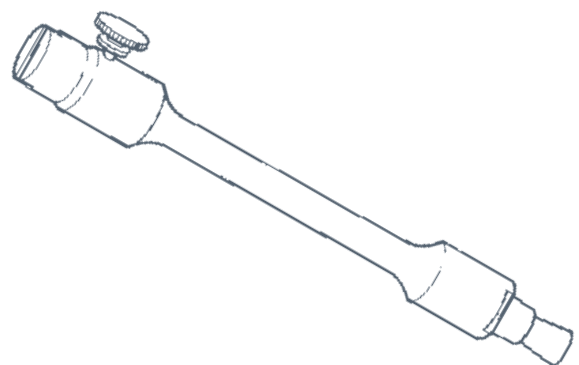

### Hudson

5140/05 for use with Hudson Brace



BURS



**Hudson Conical**

- 5150/05 9mm
- 5150/10 11mm
- 5150/15 13mm
- 5150/25 16mm



**Hudson Spherical**

- 5155/10 9mm
- 5155/15 11mm
- 5155/25 13mm
- 5155/30 16mm
- 5155/35 19mm
- 5155/40 22mm



**Hudson Perforator**

- 5160/03 8mm
- 5160/05 10mm
- 5160/10 12mm
- 5160/20 15mm



**Spiral Undercut**

- 5165/05 100mm x 12mm



**Cone Ventricular**

graduated in cms, luer fitting, with stilette

- 5185/05 1.22mm diameter
- 5185/10 1.63mm diameter
- 5185/15 2.03mm diameter



**Jefferson Ventricular**

graduated in cms, luer fitting, with stilette

- 5195/05 60mm
- 5195/10 80mm
- 5195/15 100mm

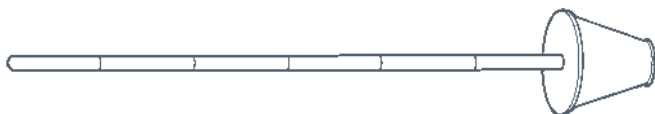

CANNULA

NEU



### CLIP FORCEPS

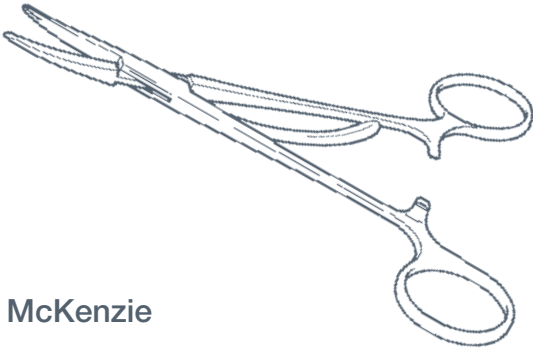

**McKenzie**

curved, applying

5205/10 140mm

5205/15 175mm



**Raney**

applying

5210/05 160mm

### CURETTES

#### American Spinal

straight, tufnol handle, 250mm

5230/05 2.0mm x 4mm

5230/10 2.5mm x 4.5mm

5230/15 2.75mm x 5mm

5230/20 3.0mm x 5.5mm

5230/25 3.25mm x 6mm

5230/30 4.0mm x 7mm

5230/35 6.0mm x 9.5mm

5230/40 7.0mm x 14mm

5230/45 9.0mm x 17mm

angled, tufnol handle, 250mm

5231/05 2.0mm x 4mm

5231/10 2.5mm x 4.5mm

5231/15 2.75mm x 5mm

5231/20 3.0mm x 5.5mm

5231/25 3.25mm x 6mm

5231/30 4.0mm x 7mm

5231/35 6.0mm x 9.5mm

5231/40 7.0mm x 14mm

5231/45 9.0mm x 17mm



NEU

### DISSECTING FORCEPS

**Adson Bayonet**

serrated, fine

5240/05 190mm

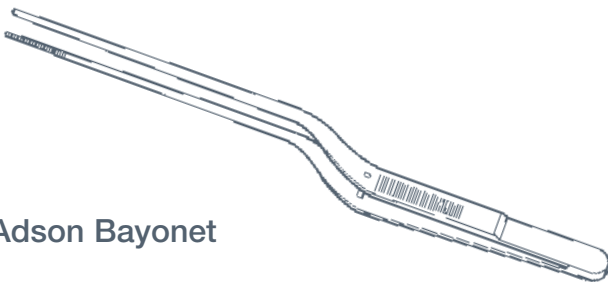

**Adson Bayonet**

1/2 teeth

5241/05 190mm

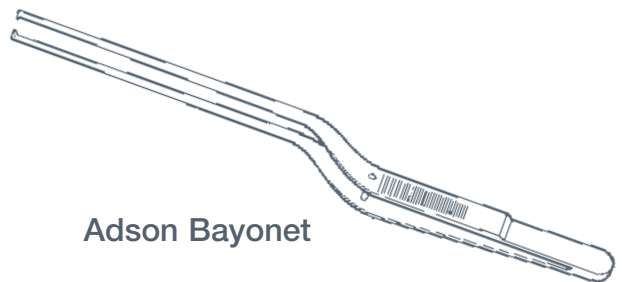



## DISSECTING FORCEPS

**Cairns**

delicate, 2/3 teeth

**5245/05** 165mm**5245/10** 215mm**Dott (Cairns)**

fine, 1/2 teeth

**5250/05** 175mm**Jefferson**

fine, 1/2 teeth

**5255/05** 175mm**Pennybacker**

3/4 teeth

**5260/05** 165mm

## DISSECTORS

**Pennybacker**

double ended

**5275/05** 225mm**Swedish**

double ended, light model

**5280/05** 175mm

NEU



# DRESSING FORCEPS

## Cairns (Dott)

fine serrated jaws  
5290/05 180mm



## Cairns

medium serrated jaws  
5290/10 215mm



## Jefferson

serrated jaws  
5295/05 180mm



# DURAL HOOKS

## Adson

blunt  
5305/05 190mm



## Adson

fine, sharp  
5306/05 190mm



## Cairns

fine, sharp  
5310/05 125mm



## Cairns

sharp  
5311/05 125mm





## ELEVATORS

**Adson Periosteal**

straight

**5335/05** 165mm x 7mm wide**Adson Periosteal**

curved

**5336/05** 165mm x 5mm wide**5336/10** 165mm x 7mm wide**Cobb****5340/05** 275mm x 10mm**5340/10** 275mm x 13mm**5340/15** 275mm x 19mm**Pennybacker**

curved, sharp

**5345/05** 160mm x 6mm wide

## GOUGES

NEU

**Capener**

cranked, tufnol handle, length 235mm

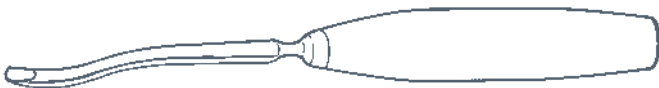
**5355/05** 6mm**5355/10** 8mm**5355/15** 11mm**5355/20** 16mm



## RETRACTORS

### Cairns Strip

malleable, copper

- 5470/05 200mm x 6mm
- 5470/10 200mm x 8mm
- 5470/15 200mm x 10mm
- 5470/20 200mm x 11mm
- 5470/25 200mm x 13mm
- 5470/30 200mm x 16mm
- 5470/35 200mm x 19mm
- 5470/40 200mm x 25mm



### Charnley Laminectomy

set of 2, one with central hook and one with 2 blunt hooks together with spain weight (1.47kg) and chain

- 5475/05 65mm x 175mm

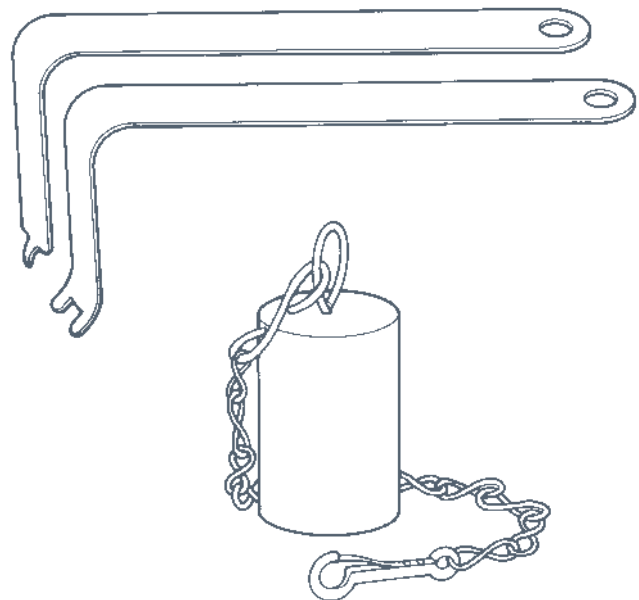





## RETRACTORS

**Cushing**

5480/05 190mm

5480/10 280mm

**Dandy**

straight

5485/05 200mm

**Hibbs**

200mm

5495/05 10mm x 38mm blades

5495/10 16mm x 54mm blades

5495/15 25mm x 70mm blades

**Love**

nerve root

5500/05 straight

5501/05 angled

5502/05 right angled

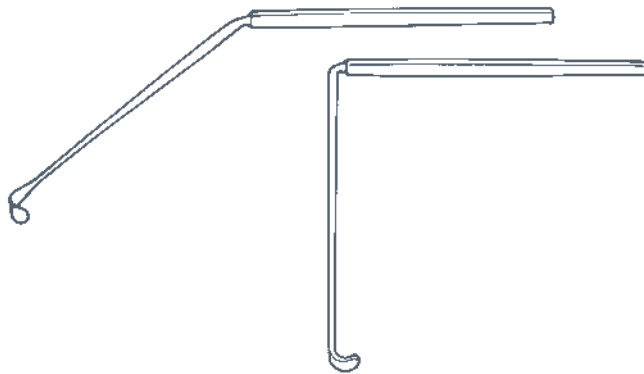
**O'Connell**

double ended

5510/05 215mm



# RETRACTORS, SELF RETAINING

## Cone

blunt, 3/4 prong

5525/05 125mm

5525/10 160mm

5525/15 200mm

5525/20 260mm

sharp, 3/4 prong

5526/05 125mm

5526/10 160mm

5526/15 200mm

5526/20 260mm

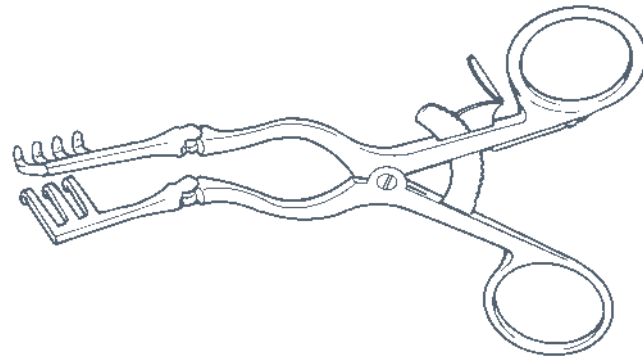

## Harvey-Jackson

hinged arms, 305mm

5550/05 38mm x 44mm blades

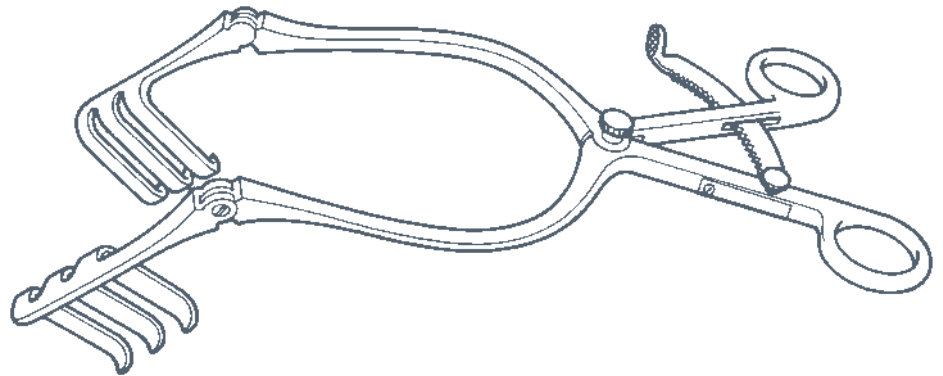

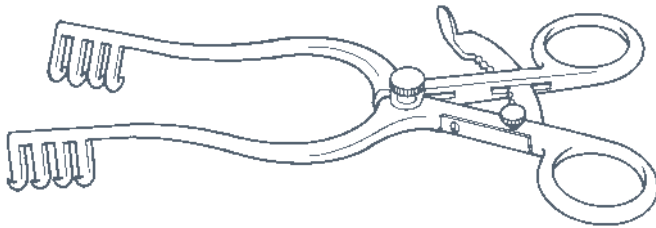
RETRACTORS,  
SELF RETAINING**Henderson**

blunt  
5560/05 135mm

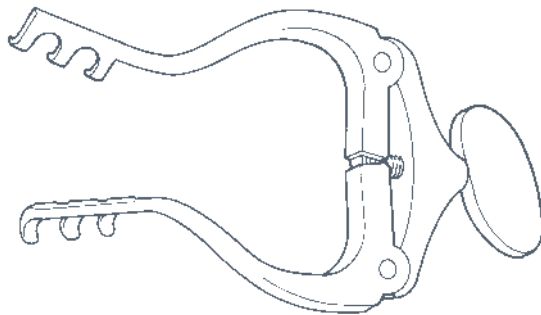
**Jansen**

blunt  
5565/05 112mm

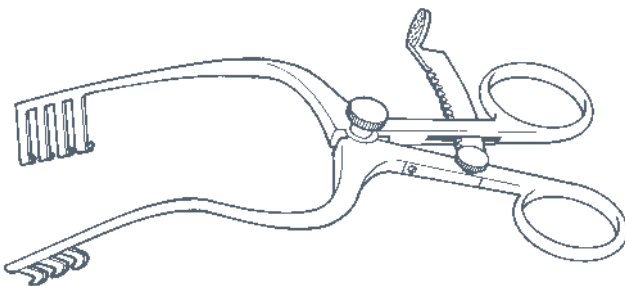
**Jefferson**

curved, blunt, 3/4 prong  
5575/05 140mm

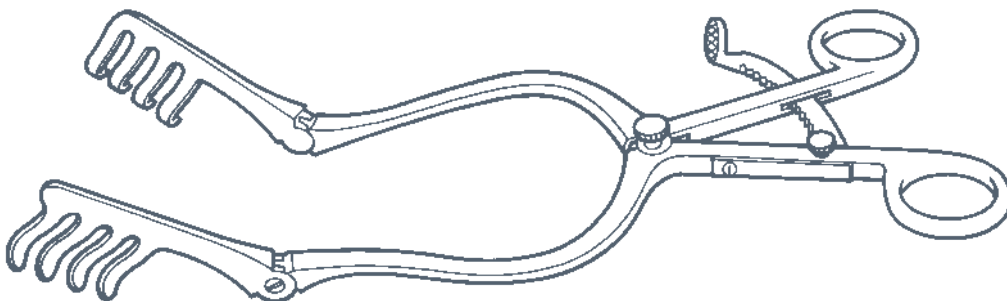
**Mayo-Adson Laminectomy**

hinged arms  
5580/05 290mm

NEU



# RONGEURS

## Beck

130mm effective length  
5625/05 2mm bite

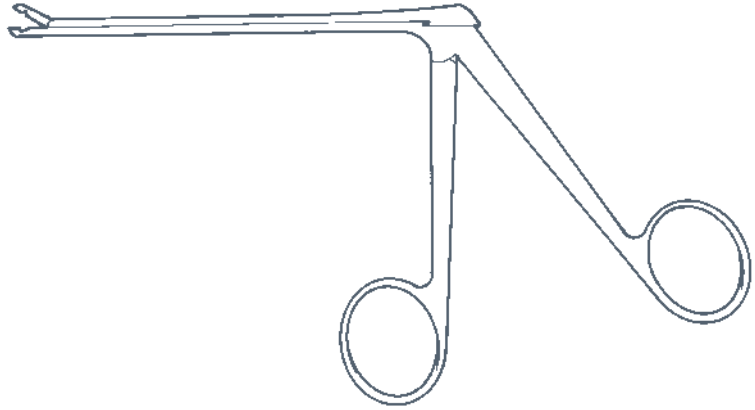

## Cushing

straight, 130mm effective length  
5630/05 4mm bite  
5630/10 5mm bite  
5630/15 7mm bite

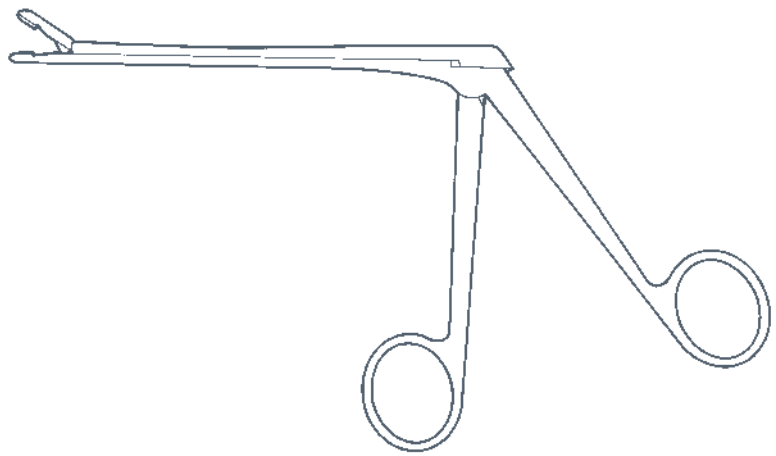

## Cushing

angled upward, 130mm effective length  
5631/05 3mm bite  
5631/10 4mm bite  
5631/15 5mm bite

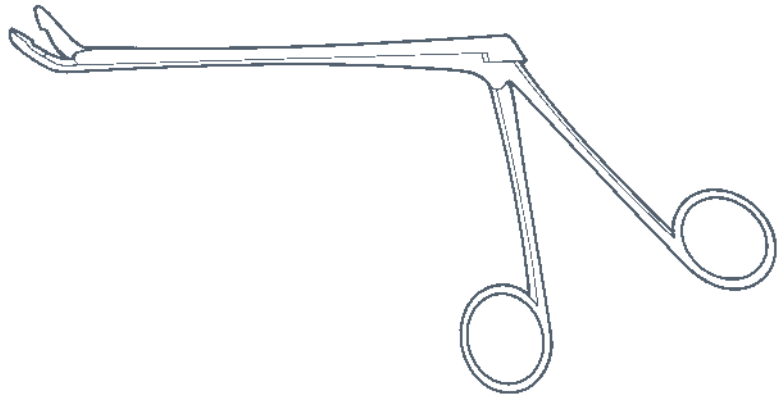

## Cushing

angled downward, 130mm effective length  
5632/05 3mm bite  
5632/10 4mm bite

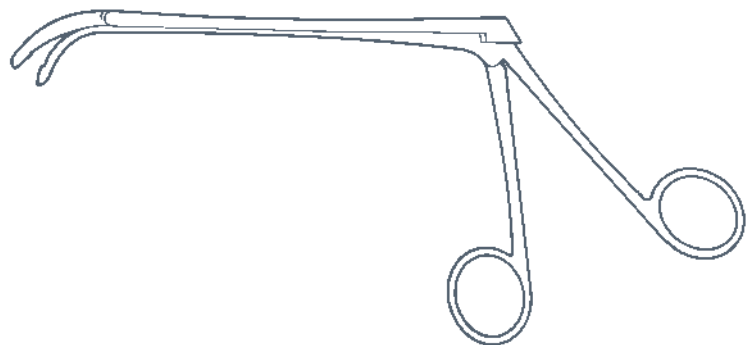

NEU



## RONGEURS

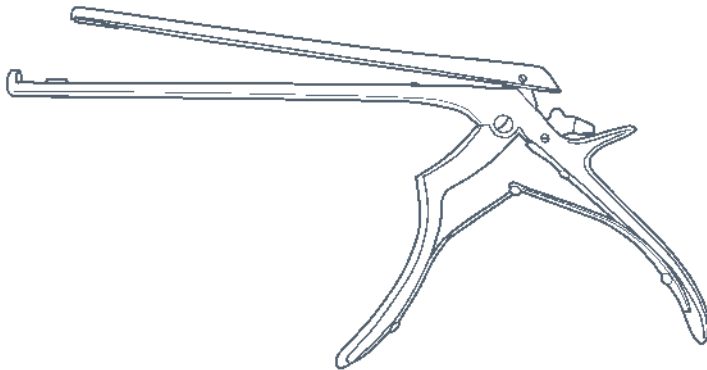

### Ferris-Smith-Kerrison

one piece hinge system allows ease of disassembly, cleaning and reassembly

upward cutting, 180mm effective length

**5637/05** 1mm bite

**5637/10** 2mm bite

**5637/15** 3mm bite

**5637/20** 4mm bite

**5637/25** 5mm bite

**5637/30** 6mm bite

40° upward cutting, 180mm effective length

**5638/05** 1mm bite

**5638/10** 2mm bite

**5638/15** 3mm bite

**5638/20** 4mm bite

**5638/25** 5mm bite

**5638/30** 6mm bite

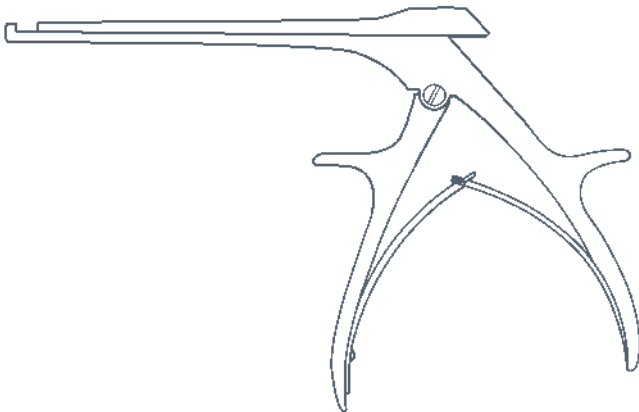

### Kerrison

upward cutting, 180mm effective length

**5671/05** 2mm bite

**5671/10** 3mm bite

40° upward cutting, 180mm effective length

**5673/05** 3mm bite

**5673/10** 4mm bite

**5673/15** 5mm bite

NEU

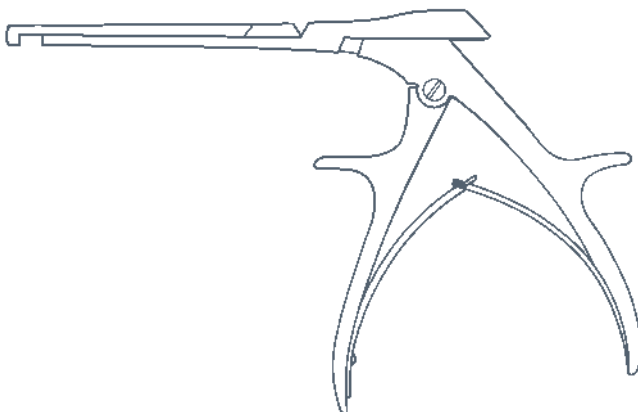

### Kerrison

downward cutting, 180mm effective length

**5675/05** 2mm bite

**5675/10** 3mm bite

40° downward cutting, 180mm effective length

**5677/05** 3mm bite

**5677/10** 4mm bite

**5677/15** 5mm bite



# RONGEURS

## Love-Grunwald

straight, 180mm effective length

5685/05 3mm bite

curved upward, 180mm effective length

5686/05 3mm bite

curved downward, 180mm effective length

5687/05 3mm bite

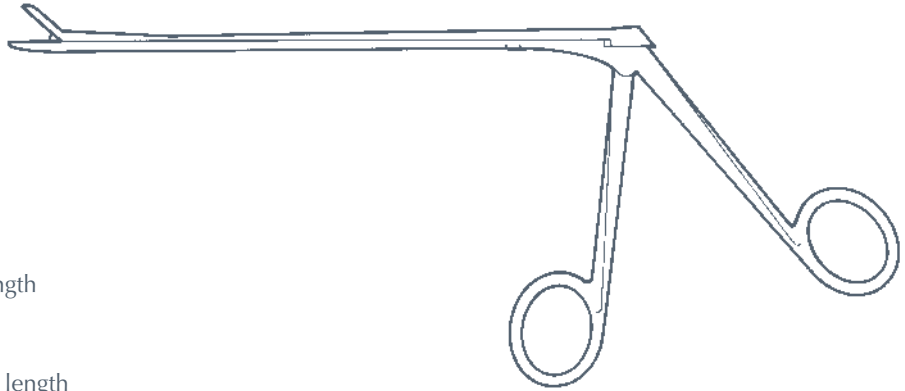

## Northfield

curved upward, 130mm effective length

5690/05 4mm bite

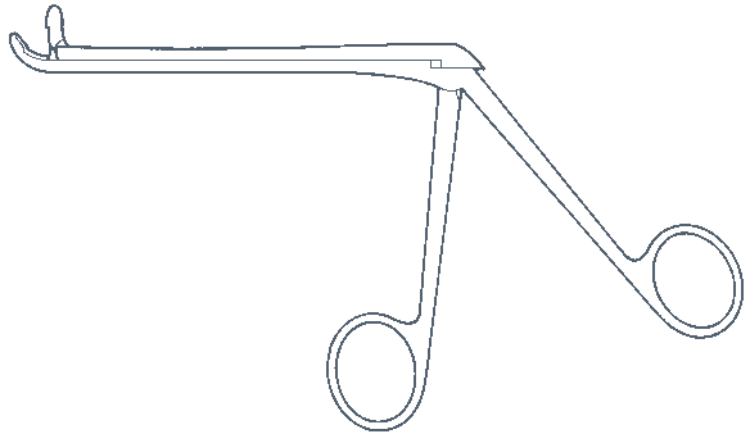

NEU

## Pennybacker

straight, 115mm effective length

5695/05 3mm bite

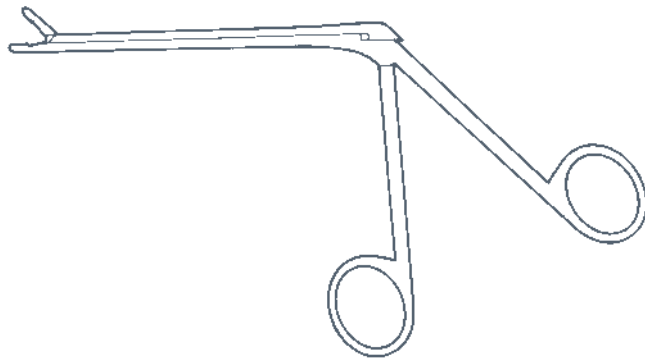

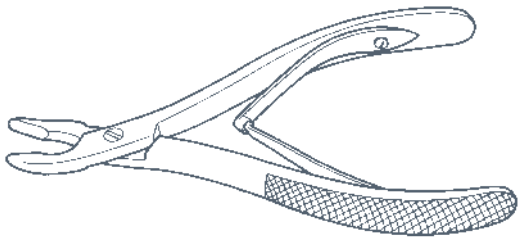

## RONGEURS

**Glasgow**

curved on flat, screw joint, 145mm  
5715/05 4mm bite

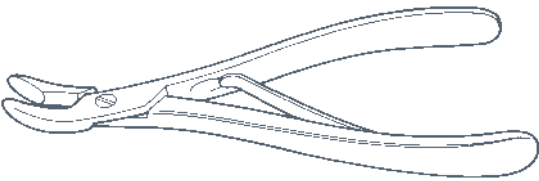
**Jansen**

small curve, screw joint, 150mm  
5720/05 8mm bite

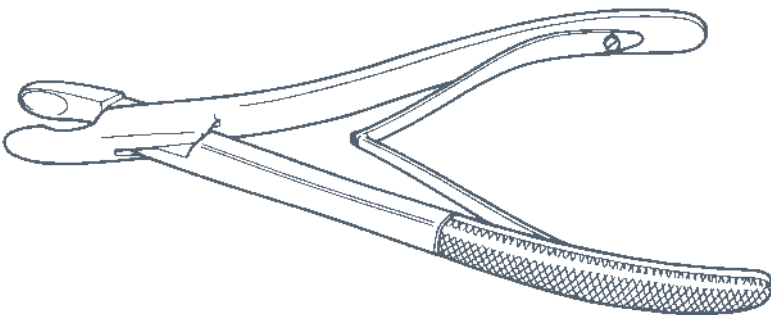
**Northfield**

straight, 200mm  
5725/05 10mm bite

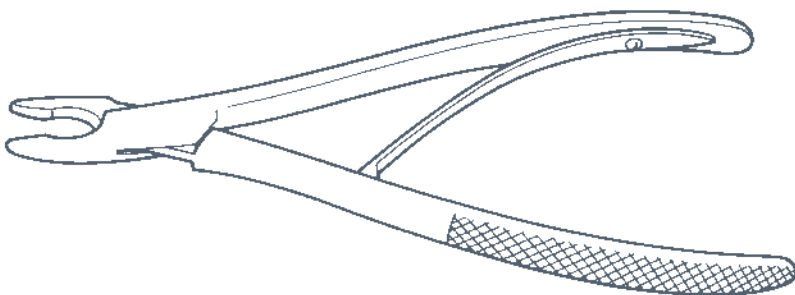
**Pennybacker**

straight, fine jaw, 200mm  
5730/05 4mm bite



# RONGEURS

## Ruskin

curved on flat, compound action, 185mm  
5735/05 6mm bite

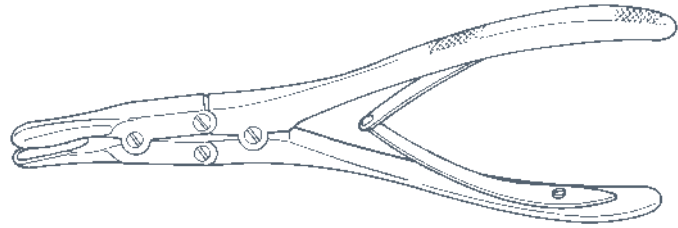

## Trotter

angled to side, screw joint, 200mm  
5745/05 10mm bite

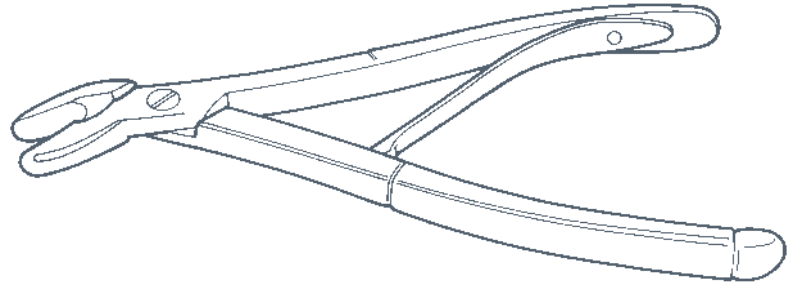

## Van Havre (Sargent)

curved on flat, compound action, 225mm  
5755/05 10mm bite

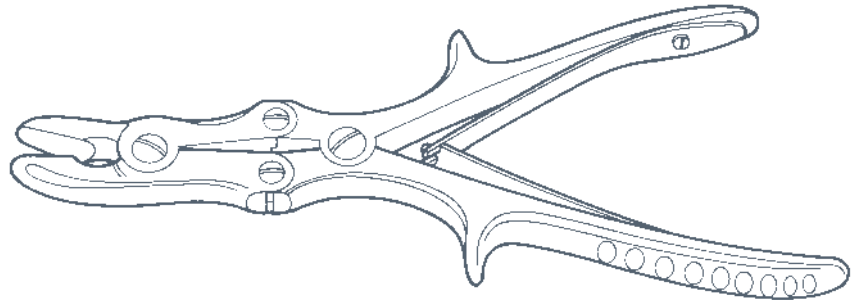

# SAWS

## De Martel Gigli Guide

5780/05 305mm



## Gigli

5785/05 305mm

5785/10 500mm

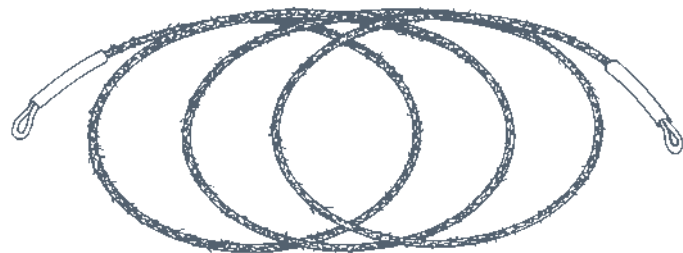

## Gigli Handle

pair

5790/05 50mm

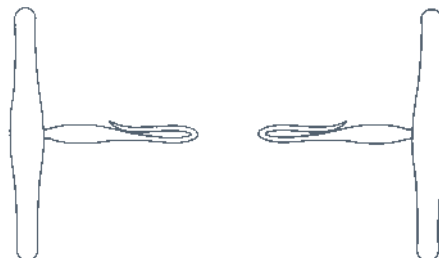

NEU



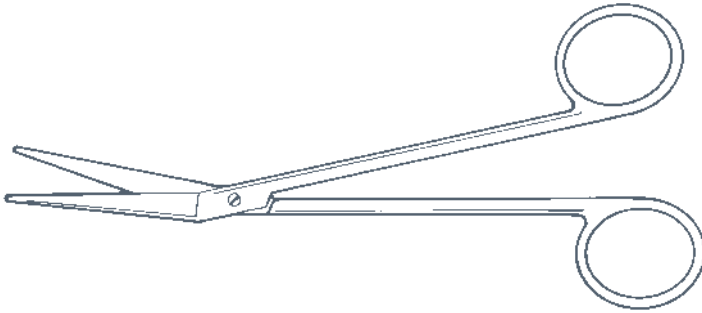

## SCISSORS

**Cairns**

angled on flat  
5800/05 175mm

**McKissock**

dural, straight  
5825/05 145mm

**McKissock**

dural, curved  
5826/05 145mm

## SHEARS

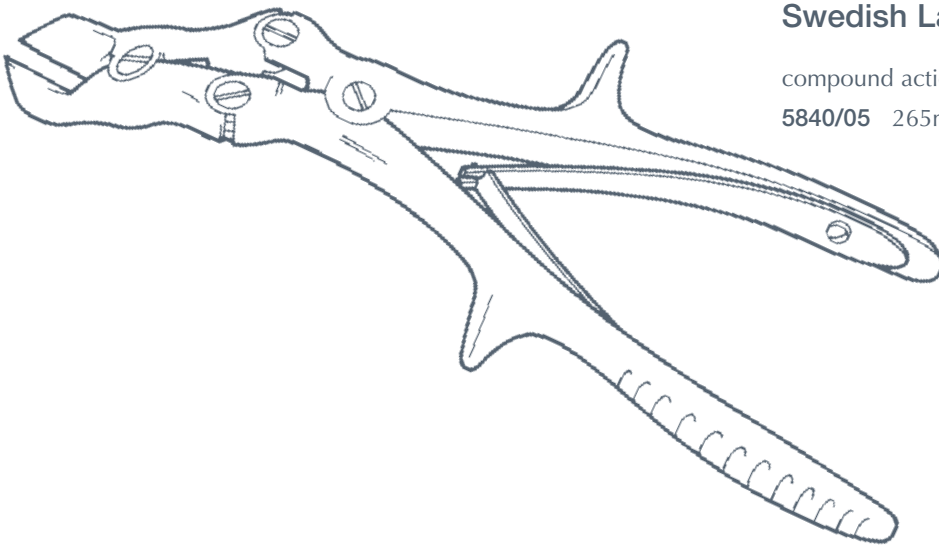
**Swedish Laminectomy**

compound action  
5840/05 265mm

NEU

## SUCTION TUBES

**Adson Frazier**

angled, 175mm  
5880/05 7fg, 2.3mm  
5880/10 8fg, 2.7mm  
5880/15 9fg, 3.0mm



ORTH

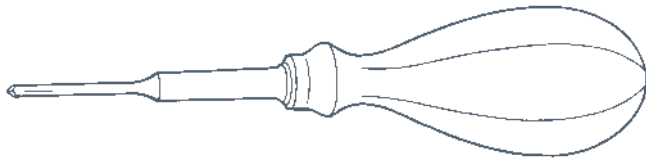

## AWLS

**Bone**

straight with eye

6075/05 2.0mm diameter, 125mm

6075/10 2.4mm diameter, 130mm

6075/15 2.8mm diameter, 145mm

6075/20 3.2mm diameter, 160mm

6075/25 3.6mm diameter, 165mm

6075/30 4.0mm diameter, 175mm

## BONE CURETTES

**Charnley**

6085/05 small, 300mm

6085/10 large, 375mm

**Stanley Boyd**

double ended

6090/05 small, 150mm

6090/10 medium, 200mm

6090/15 large, 250mm

**Volkman**

double ended, 220mm

6095/05 small

6095/10 medium

6095/15 large

**Volkman**

single ended, oval, 180mm

6096/05 No.1

6096/10 No.2

6096/15 No.3

6096/20 No.4

6096/25 No.5

6096/30 No.6



# BONE CUTTING

## FORCEPS

### Horsley

compound action, straight

6100/05 270mm

compound action, angled

6101/05 270mm

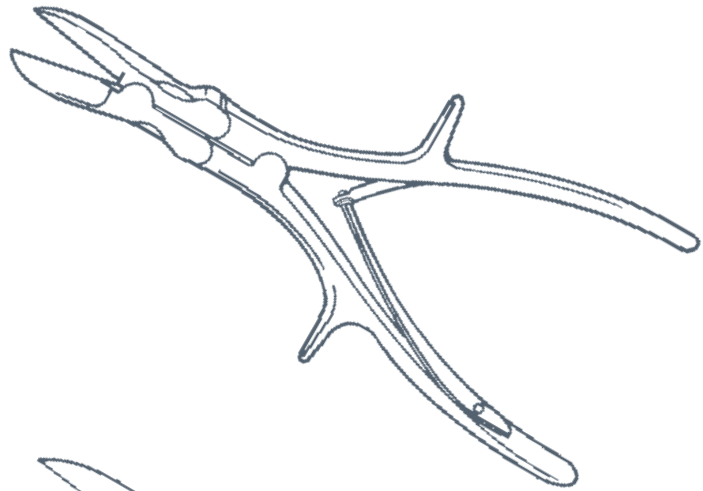

### Liston

straight

6105/05 150mm

6105/10 180mm

6105/15 200mm

6105/20 230mm

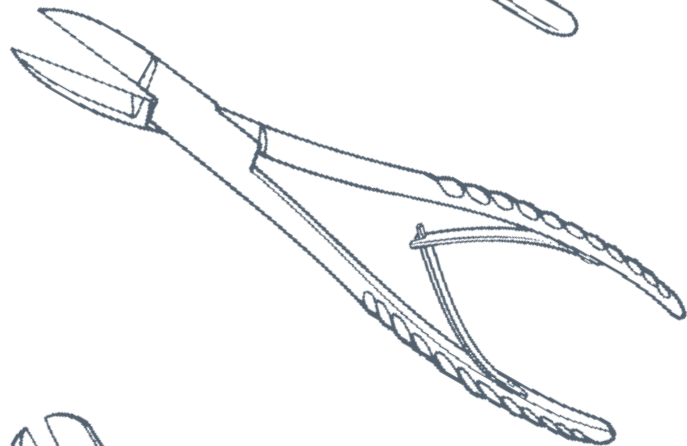

### Liston

curved

6106/05 150mm

6106/10 180mm

6106/15 200mm

6106/20 230mm

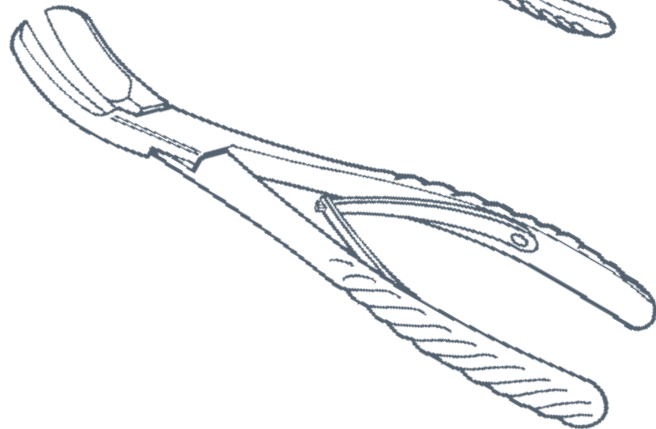

### Liston

angled

6107/05 150mm

6107/10 180mm

6107/15 200mm

6107/20 230mm

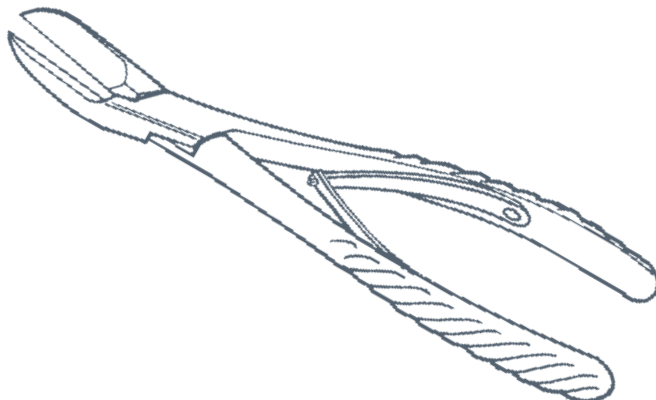



BONE CUTTING  
FORCEPS

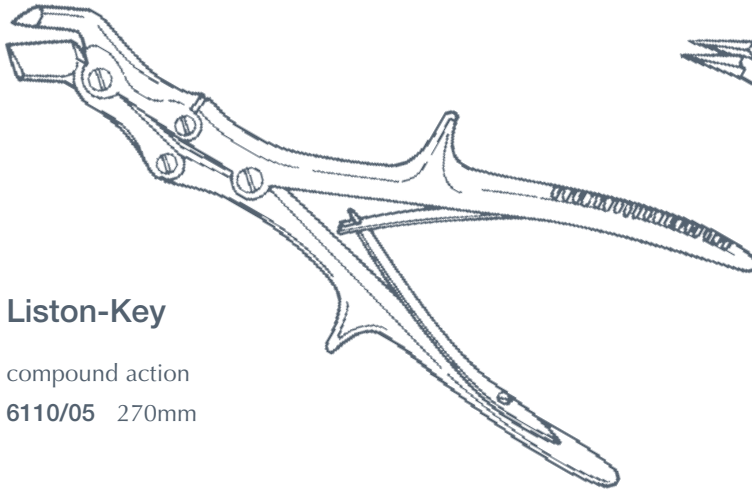

**Liston-Key**

compound action  
6110/05 270mm



**McIndoe**

compound action  
6115/05 190mm

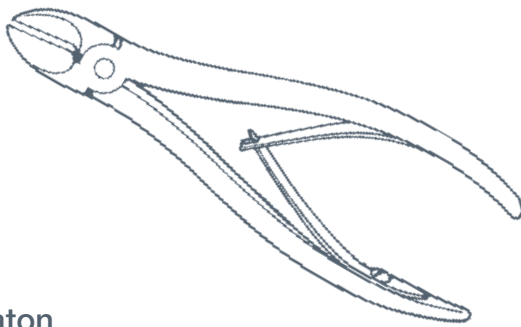

**Paton**

6120/05 140mm

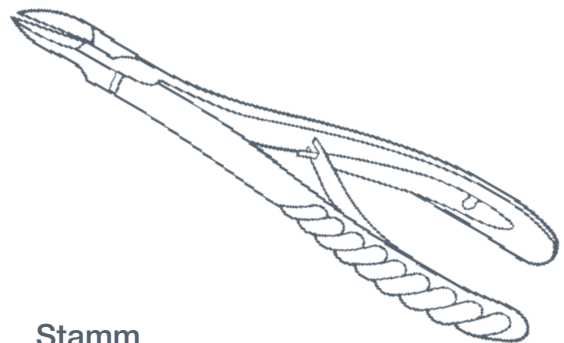

**Stamm**

6125/05 140mm

BONE HOLDING  
CLAMPS

ORTH

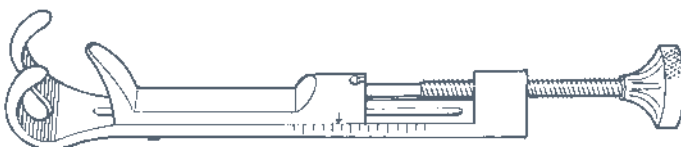

**Lowman**

6130/05 120mm  
6130/10 175mm  
6130/15 200mm  
6130/20 220mm



# BONE HOLDING FORCEPS

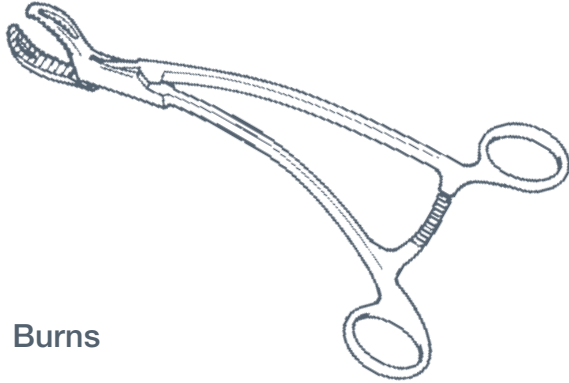

**Burns**

6135/05 190mm

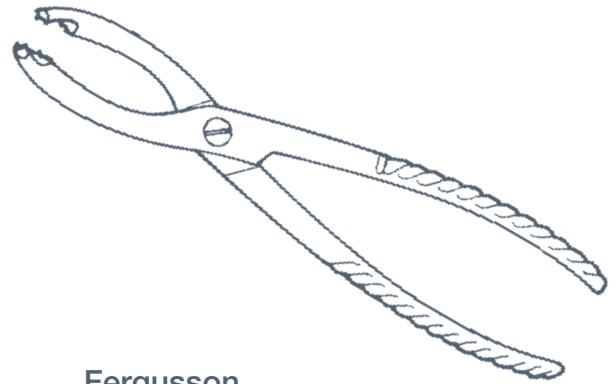

**Fergusson**

screw joint  
6140/05 150mm  
6140/10 200mm

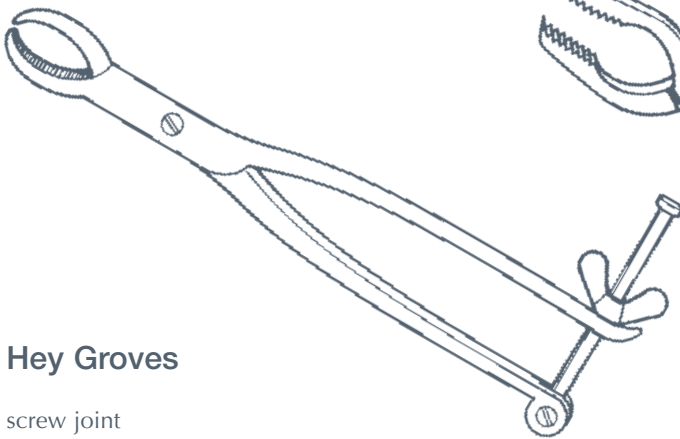

**Hey Groves**

screw joint  
6145/05 200mm  
6145/10 255mm  
6145/15 305mm

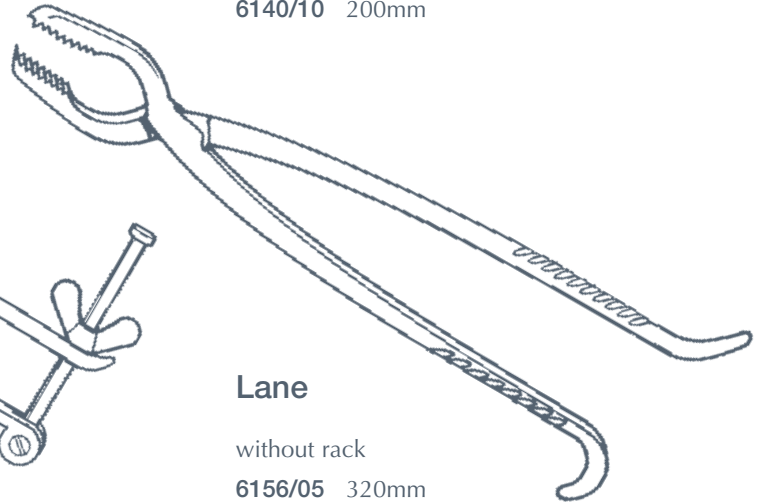

**Lane**

without rack  
6156/05 320mm  
6156/10 450mm

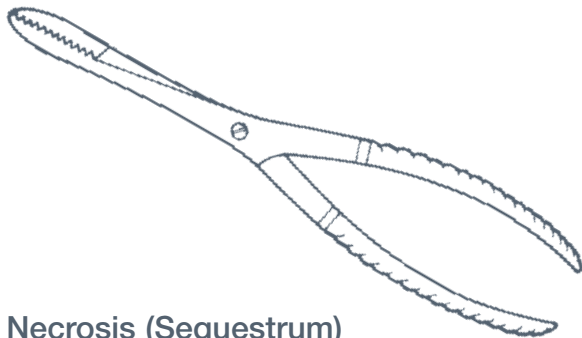

**Necrosis (Sequestrum)**

straight, screw joint  
6165/05 190mm  
6165/10 200mm

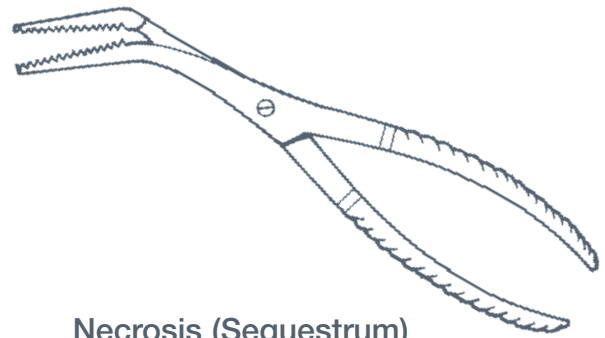

**Necrosis (Sequestrum)**

angled, screw joint  
6166/05 190mm  
6166/10 200mm



## BONE HOLDING FORCEPS

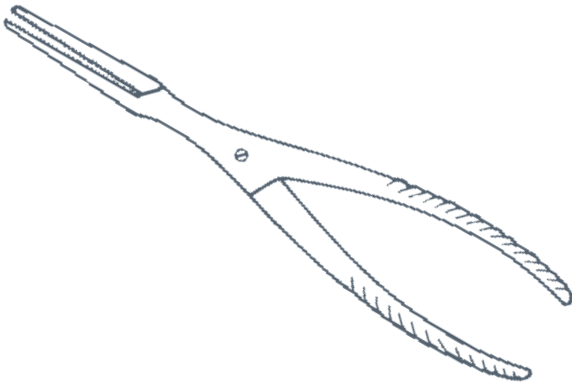

### Necrosis (Sequestrum)

long fine jaws, screw joint

6167/10 200mm

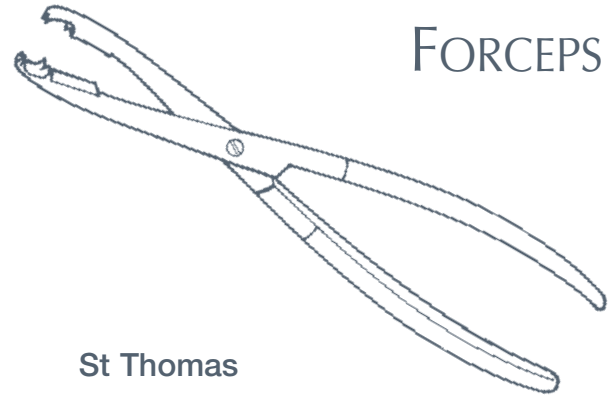

### St Thomas

screw joint

6170/05 175mm

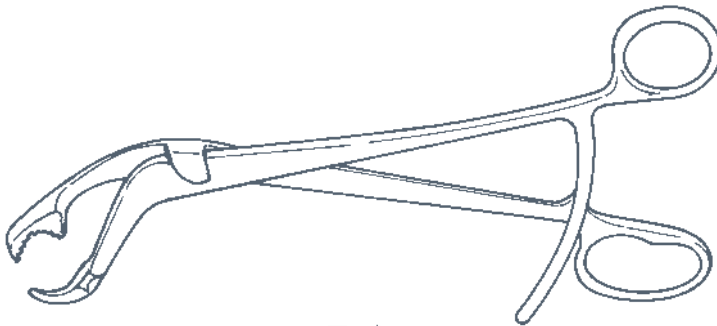

### Verbrugge

6180/05 250mm, 9.5mm jaw

6180/10 260mm, 10.5mm jaw

6180/15 270mm, 12mm jaw

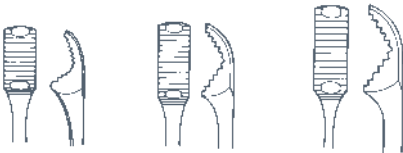

## BONE HOOKS



### Langenbeck

6183/05 195mm



### Kocher

6184/05 220mm



## BONE LEVERS

### Bankhart

6185/05 300mm



### Bennett

6190/05 240mm

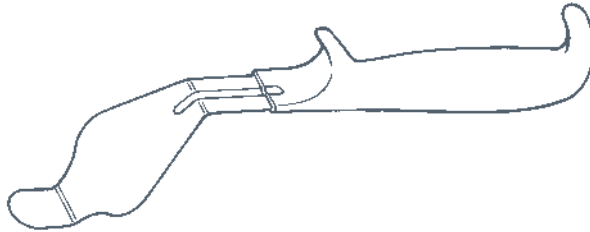

### Charnley

curved blade

6192/05 220mm



### Fagge

6193/05 275mm



### Lane

heavy, solid handle

6195/05 355mm



### Lane

ring handle

6196/05 265mm



### Lane

serrated end

6197/05 260mm



### Murphy Skid

6200/05 330mm



### Trethowan

ring handle

6205/05 215mm







## BURS

## Paton



155mm

6290/05 3.5mm diameter

6290/10 4.5mm diameter

6290/15 5.0mm diameter

## CHISELS

## Capener



tufinol handle, length 250mm

6305/05 10mm

6305/10 12mm

6305/15 15mm

6305/20 20mm

6305/25 25mm

6305/30 30mm

6305/95 set of 6

## Smith Petersen



length 200mm

6320/05 6mm

6320/10 10mm

6320/15 13mm

6320/20 15mm

6320/25 20mm

6320/30 25mm

6320/35 30mm

## Swedish



length 200mm

6325/03 6mm

6325/05 10mm

6325/08 13mm

6325/10 15mm

6325/15 20mm

6325/20 25mm

6325/25 30mm



# DISSECTING FORCEPS

## Jackson Burrows

serrated, 1/2 teeth  
6330/25 140mm



## Jackson Burrows

with tongue and groove in jaw  
6330/50 140mm



# ELEVATORS

## Bristow

sharp  
6335/05 230mm



## Cobb

periosteal  
6340/05 200mm



## Spinal

305mm  
6345/05 18mm wide



# FILES

## Bone Rasp/File

combined  
6350/05 220mm



## Tubby

6355/05 305mm





## GOUGES

**Smith-Petersen**

straight, length 200mm

6375/05 10mm

6375/10 15mm

6375/15 20mm

6375/20 25mm

**Swedish**

straight, length 200mm

6380/03 6mm

6380/05 10mm

6380/08 13mm

6380/10 15mm

6380/15 20mm

6380/20 25mm

6380/25 30mm

**Tufnol Handle**

straight, length 230mm

6385/05 10mm

6385/10 15mm

6385/15 20mm

6385/20 25mm

6385/25 30mm



## HAND DRILLS

**Pistol Grip**

with Jacobs chuck and key

6395/05 complete

6395/10 Jacobs chuck key

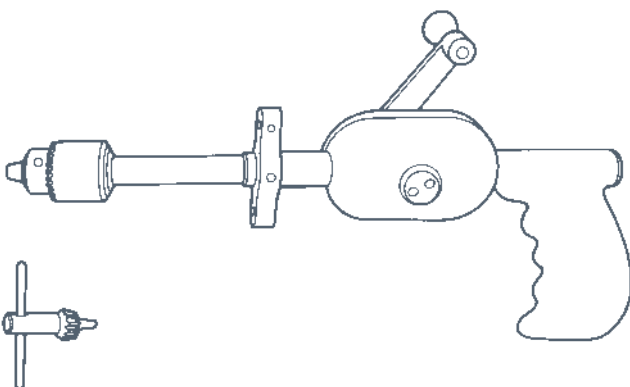



# HAND DRILLS

## Ralk

complete with chuck  
6400/05 opens to 6.35mm

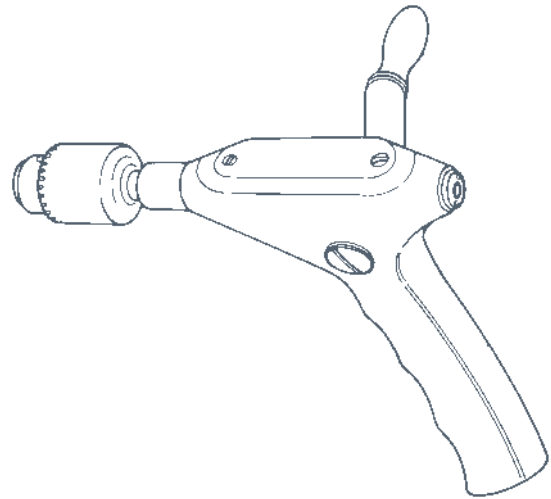

# HAND SPLINT

## Lead

6410/05 adult, 370mm x 310mm  
6410/10 child, 275mm x 160mm

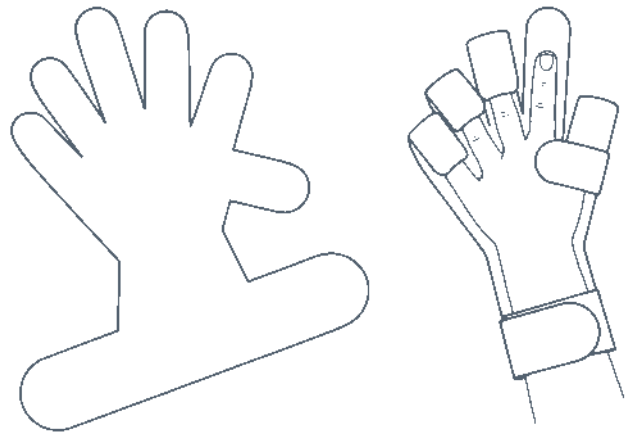

# KNIVES

## Adams Tenotomy

6450/05 fig 1, 145mm



## Adams Tenotomy

6450/10 fig 2, 140mm



## Adams Tenotomy

6450/15 fig 3, 140mm





## KNIVES

**Adams Tenotomy**

6450/20 fig 4, 135mm

**Guy's Tenotomy**

6455/05 140mm

**Jones Tenotomy**

6460/05 135mm

**Monro Menisectomy**

6470/05 175mm

**Parker Tenotomy**

6475/05 fig 1, 13mm blade

6475/10 fig 2, 20mm blade

6475/15 fig 3, 13mm blade

6475/20 fig 4, 15mm blade

**Smillie Menisectomy**

6480/25 straight, 175mm

**Smillie Menisectomy**

6480/50 curved to left, 175mm

**Smillie Menisectomy**

6480/75 curved to right, 175mm



# KNIVES

## Tenotomy

blunt

6485/25 30mm blade



## Tenotomy

sharp

6485/50 30mm blade



## Tubby Tenotomy

6490/05 135mm



# MALLETS

## Hajek

220mm, 27mm diameter

6510/05 140grms

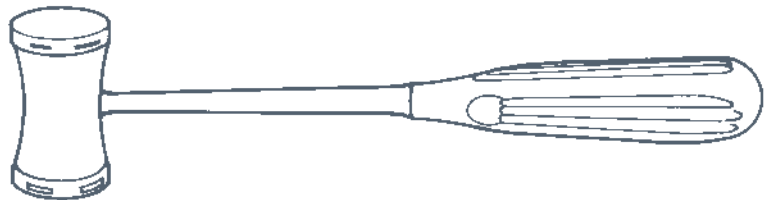

## Heath

copper head, electro plated

6515/05 18oz

6515/10 28oz

6515/15 32oz

6515/20 36oz

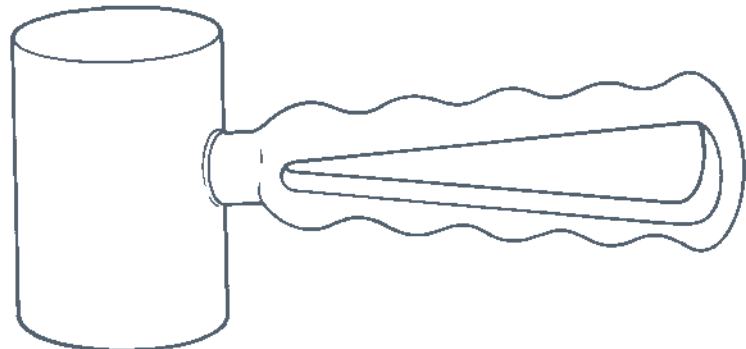

ORTH

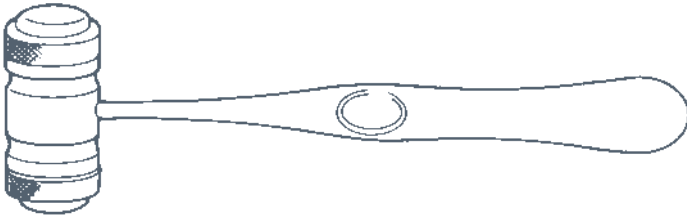

## MALLETS

**Mead**

170mm, 26mm diameter, with interchangeable faces

6520/05 320grms

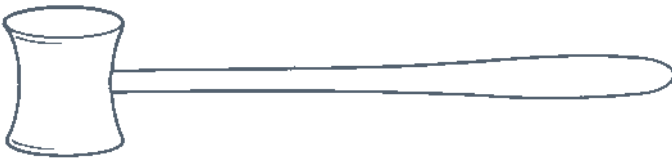
**Stainless Steel**

6525/05 8oz

## OSTEOTOMES

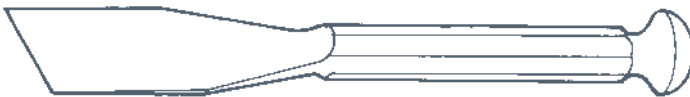
**Albee**

length 190mm

6585/05 38mm

6585/10 50mm

**Capener**

straight, tufnol handle, 250mm

6590/05 10mm

6590/10 12mm

6590/15 15mm

6590/20 20mm

6590/25 25mm

6590/30 30mm

6590/95 set of 6



# OSTEOTOMES

## Capener

curved, tufnol handle, 250mm

6595/05 10mm

6595/10 12mm

6595/15 15mm

6595/20 20mm

6595/25 25mm

6595/30 30mm

6595/95 set of 6



## Smith-Petersen

straight, 200mm

6600/05 10mm

6600/10 15mm

6600/15 20mm

6600/20 25mm

6600/25 30mm



## Smith-Petersen

curved, 200mm

6601/05 10mm

6601/10 15mm

6601/15 20mm

6601/20 25mm

6601/25 30mm



## Swedish

straight, 200mm

6605/03 6mm

6605/05 10mm

6605/08 13mm

6605/10 15mm

6605/15 20mm

6605/20 25mm

6605/25 30mm





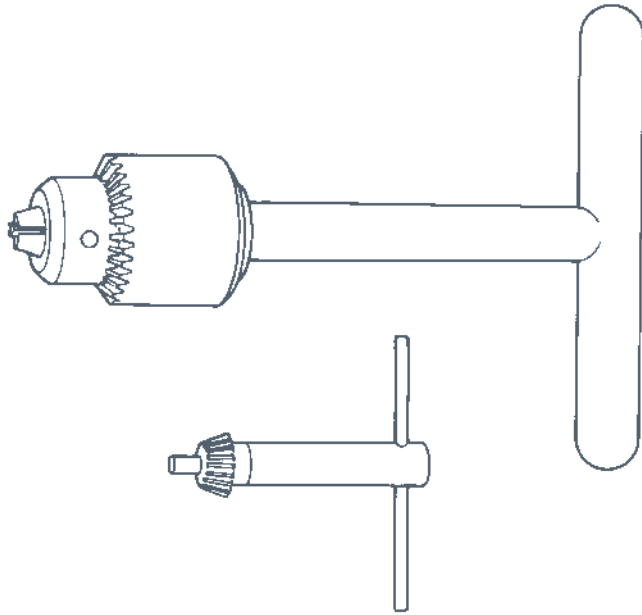

## PIN INTRODUCER

### Steinmann

complete with Jacobs chuck and key

6615/05 140mm

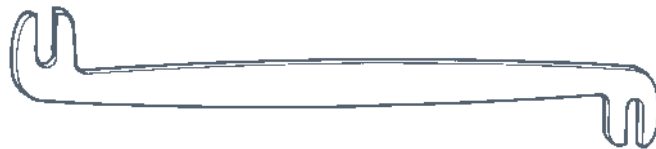

## PLATE BENDER

### Lane

6618/05 2 required in use

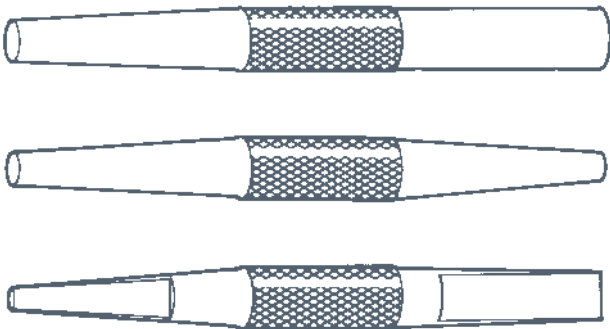

## PUNCHES

### McGoey

double ended

6640/05 fig 1, 19mm x 13mm

6640/10 fig 2, 10mm x 6mm

6640/15 fig 3, 13mm x 6mm



## RASPATORIES

### St Thomas

Length 180mm

6658/25 pointed

6658/50 round



# RASPS

## Putti

flat both ends  
6685/25 270mm



## Putti

rounded one end  
6685/50 300mm



# RETRACTORS

## Charnley

6688/05 215mm, 50mm x 6mm blade



## Charnley Initial Incision

6690/05 305mm

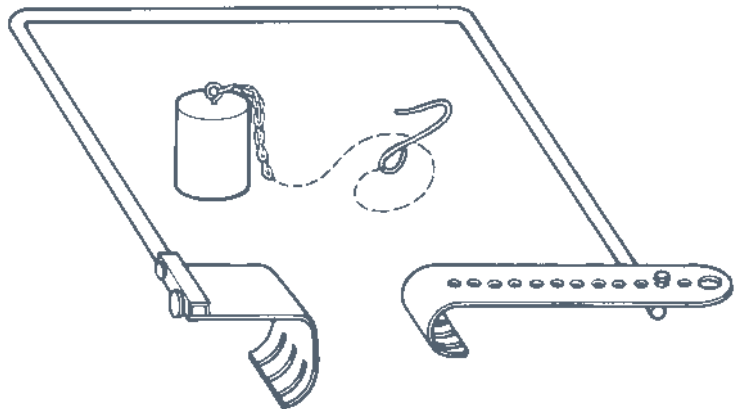

## Hohmann-Muller Spike

- 6695/05 8mm
- 6695/10 18mm
- 6695/15 43mm
- 6695/20 70mm

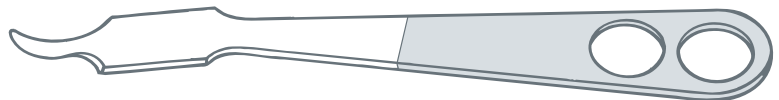

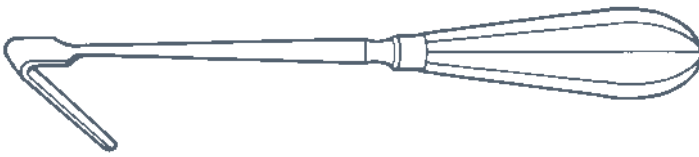

## RETRACTORS

**Jackson Burrows**

broad, angled  
6700/25 220mm

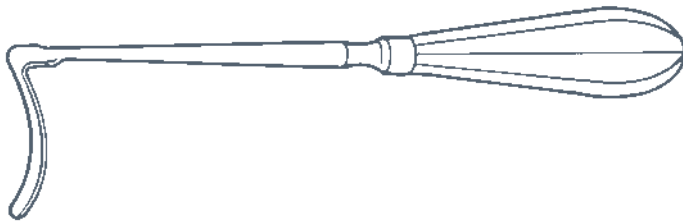
**Jackson Burrows**

narrow, curved  
6700/50 220mm

**Smillie Hook**

angled, 145mm  
6708/05 32mm x 19mm blade

**Smillie Hook**

angled, 145mm  
6708/10 41mm x 19mm blade

**Smillie Hook**

angled, 145mm  
6708/15 57mm x 19mm blade

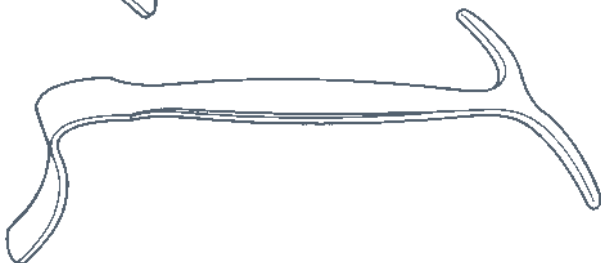
**Smillie Hook**

right angled, curved, 145mm  
6709/05 10mm blade

**Smillie Hook**

set of 2  
6710/05 145mm



# RETRACTORS, SELF RETAINING

## Jackson Burrows

6715/05 175mm

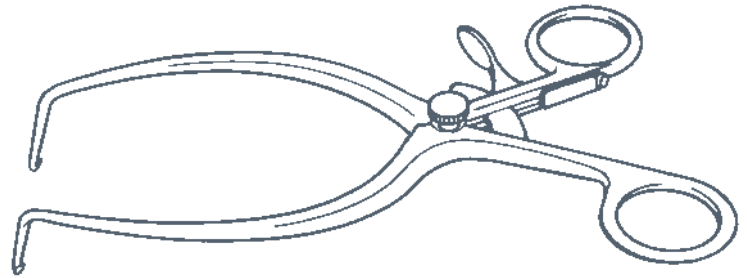

# RONGEURS

## Jansen

curved, compound action

6720/05 180mm

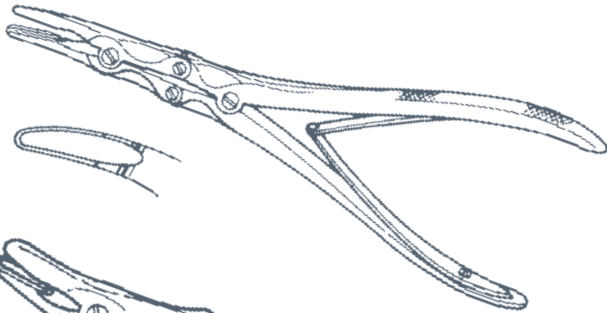

## Leksell

compound action

6725/05 230mm, 4mm jaw

6725/10 230mm, 6mm jaw

6725/15 230mm, 8mm jaw



## Lempert

straight

6730/10 190mm

curved

6731/05 160mm

6731/10 190mm

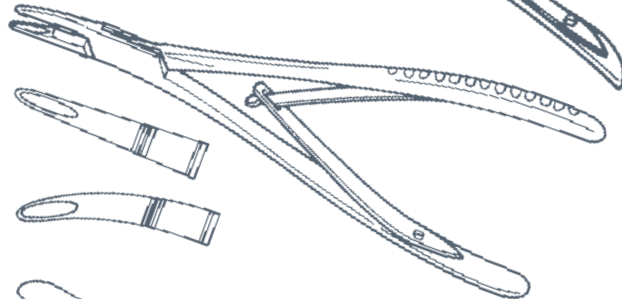

## Luer

straight, large

6735/25 170mm

curved, large

6735/50 170mm

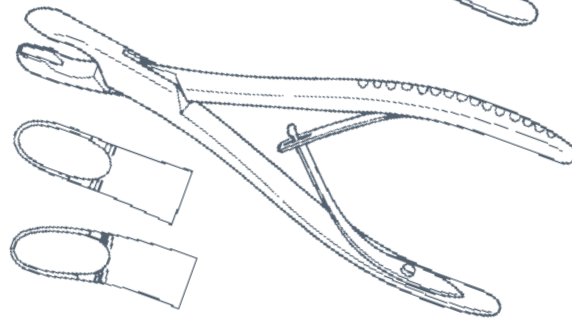

## Luer

curved, small

6736/05 150mm

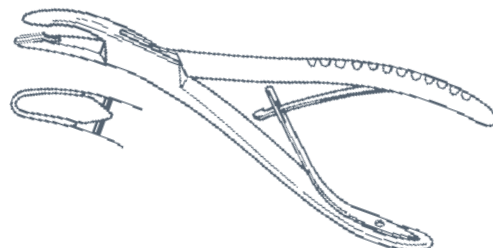



RUGINES

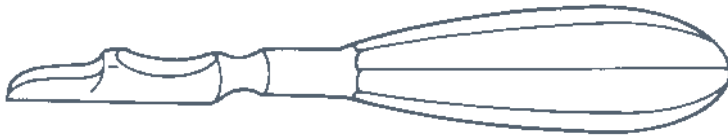

**Farabeuf**

straight, hollow handle  
6740/25 160mm

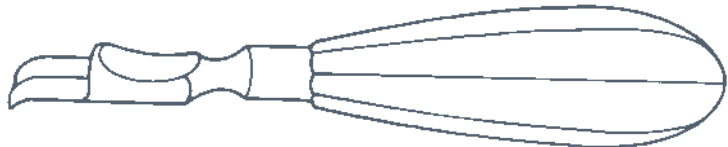

**Farabeuf**

curved, hollow handle  
6740/50 160mm



**Farabeuf**

straight, flat handle  
6741/25 150mm



**Farabeuf**

curved, flat handle  
6741/50 150mm

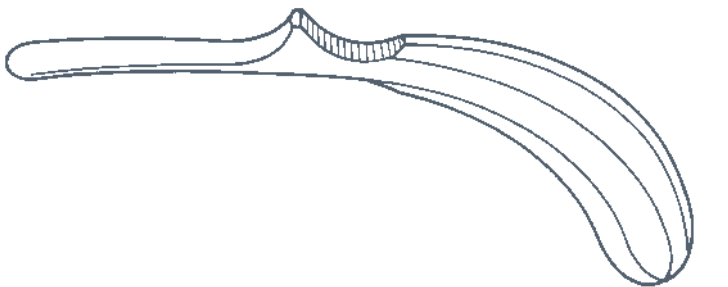

**Jones**

pistol handle, fan shape  
6745/05 185mm

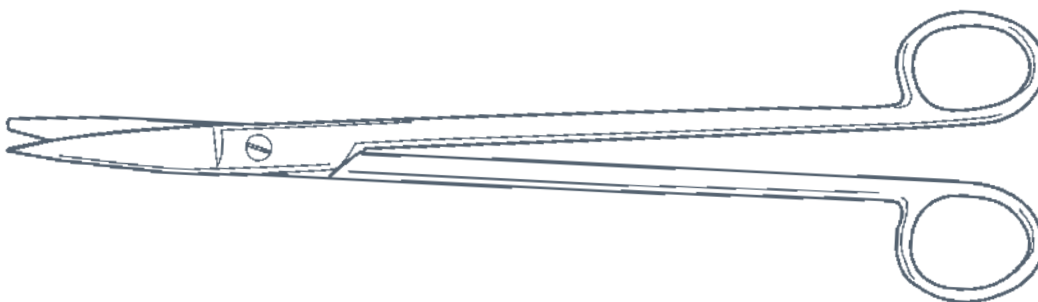

SCISSORS

**Capsulotomy**

angled  
6800/05 250mm



# SPRING CLIP

**Serrated**

6820/05 65mm width of jaws

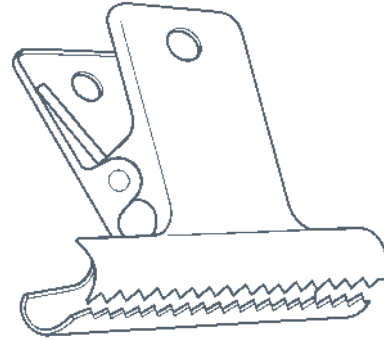

# STAPLE INSTRUMENTS

**Blount**

driver for large, small and wide staples

6825/05 160mm

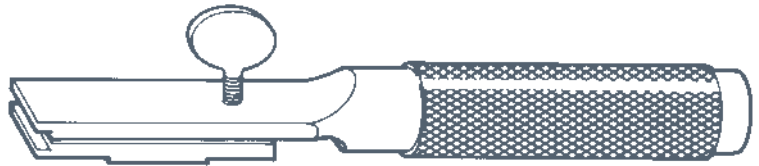

**Blount**

remover

6825/10 150mm



**Blount**

set

6825/15 165mm



**Blount**

starter, 160mm

6825/20 for 16mm staples

6825/25 for 22mm staples



# STIRRUPS

**Bohler**

rotating with swivel fixation pieces, suitable for Steinmann pins

6835/05 small, 100mm x 90mm

6835/10 medium, 165mm x 115mm

6835/15 large, 240mm x 150mm

**Bohler**

pin mount, for 4mm and 6mm pins

6836/05 22mm

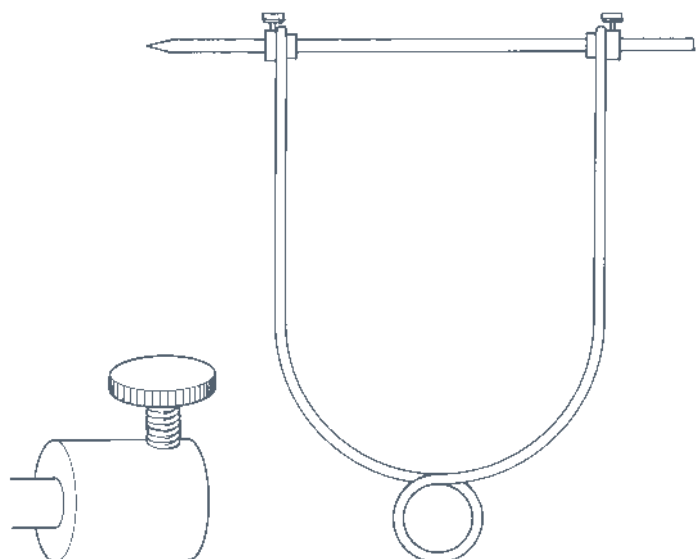

ORTH

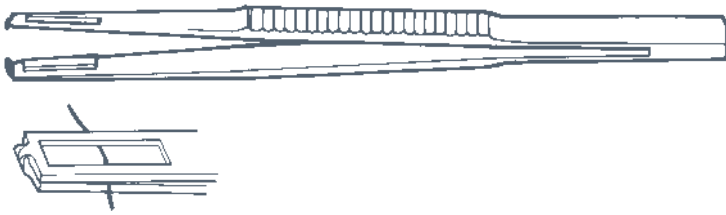

## SUTURE FORCEPS

**Charnley**

slotted, 1/2 teeth

6850/05 145mm

6850/10 180mm

## WIRE INSTRUMENTS

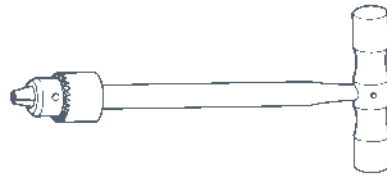
**Handle**

with chuck

6895/05 100mm

**Loute**

tightener

6900/05 210mm

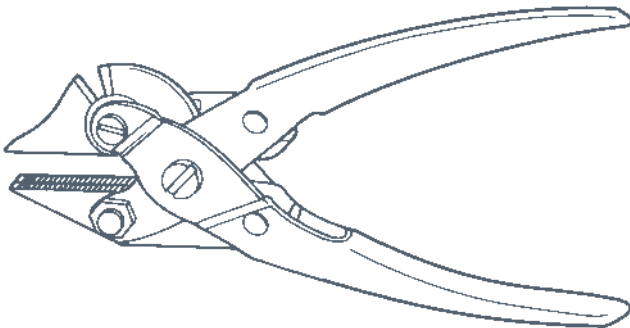
**Pliers**stainless steel with hammer end and side cutters,  
made in Pakistan

6905/05 160mm

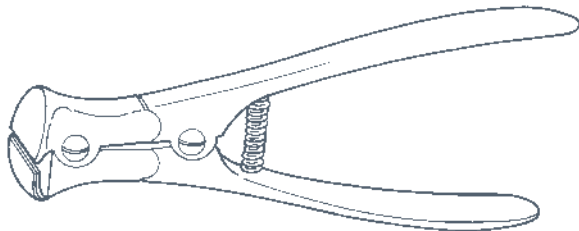
**Pliers**double action, small, to cut 1.5mm hard wire or  
2.0mm soft

6915/05 150mm

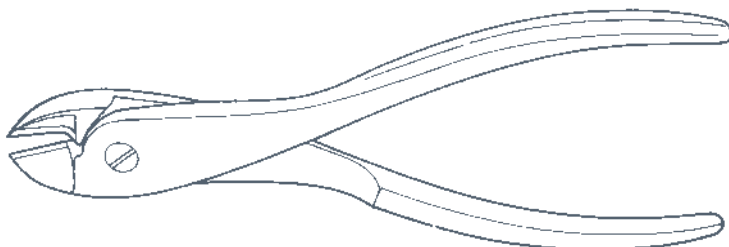
**Pliers**tungsten carbide, to cut 1.5mm hard wire or  
2.5mm soft

6920/05 185mm



ENT





ARTERY FORCEPS

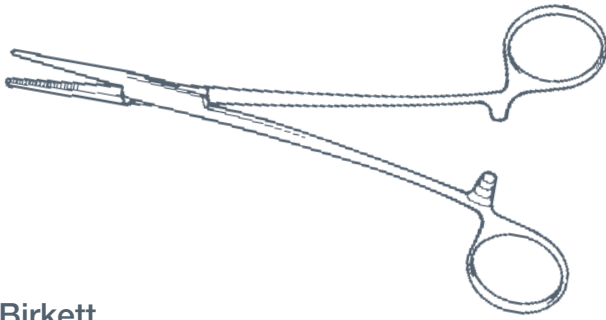

**Birkett**

straight  
7015/05 180mm

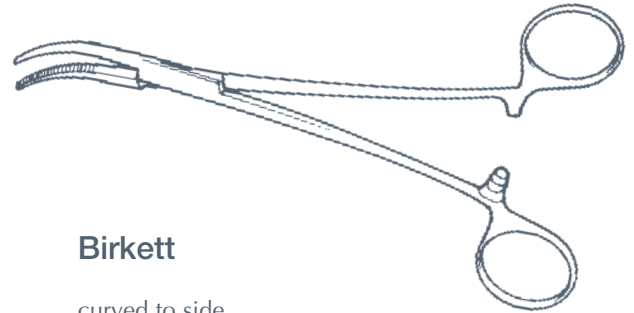

**Birkett**

curved to side  
7015/10 180mm

curved on flat  
7015/15 180mm

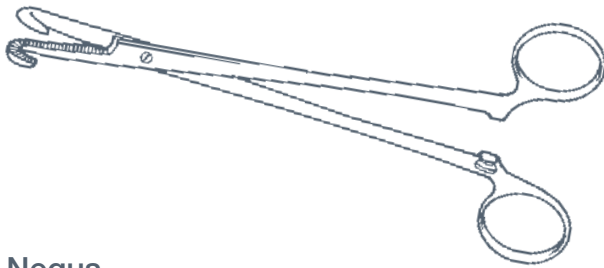

**Negus**

small curve  
screw joint  
7018/05 180mm



large curve  
screw joint  
7018/10 180mm

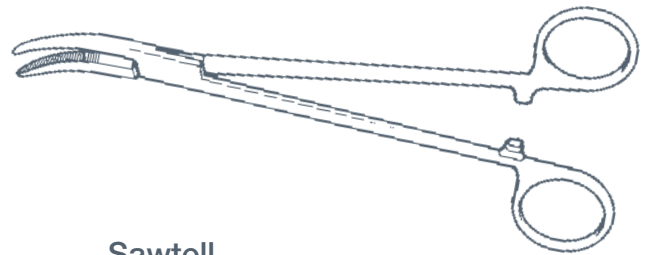

**Sawtell**

curved on flat  
7021/05 180mm

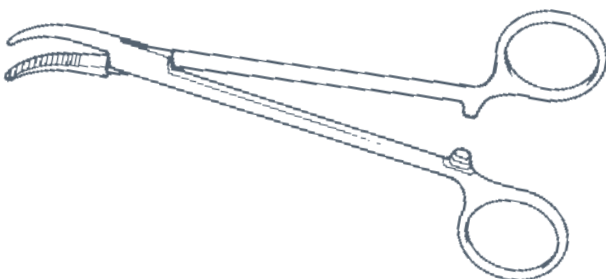

**Schnidt**

curved on flat  
7024/05 180mm

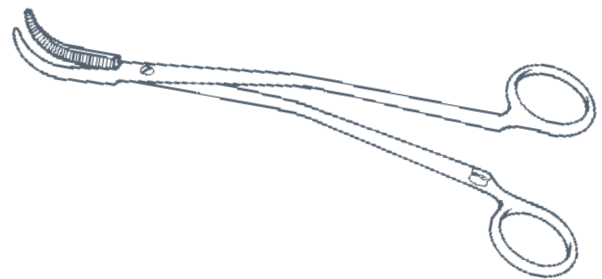

**Wilson**

curved on flat, angle shaft,  
screw joint  
7030/05 190mm





# AURAL FORCEPS

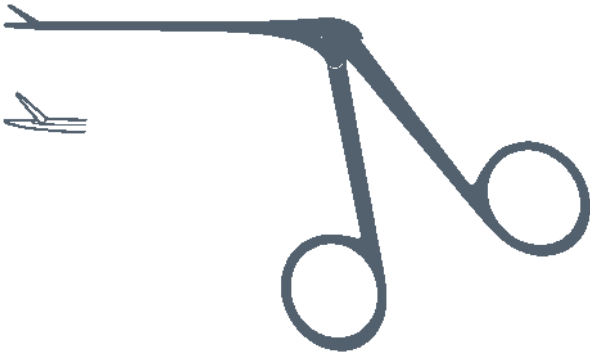

## Cawthorne

crocodile, black finish, extra fine with smooth jaws  
70mm effective length  
7038/05



## Fuller

crocodile, black finish, for introducing teflon pistons  
65mm effective length  
7041/05

## Hartmann

crocodile, black finish, extra fine with serrated jaws  
70mm effective length  
7044/25



## Hartmann

crocodile, satin finish, serrated jaws  
75mm effective length  
7044/05



crocodile, satin finish, fine tenaculum jaws  
75mm effective length  
7044/10



crocodile, satin finish, round cutting jaws  
75mm effective length  
7044/15



crocodile, satin finish, Grunwald Punch Action jaws  
75mm effective length  
7044/20

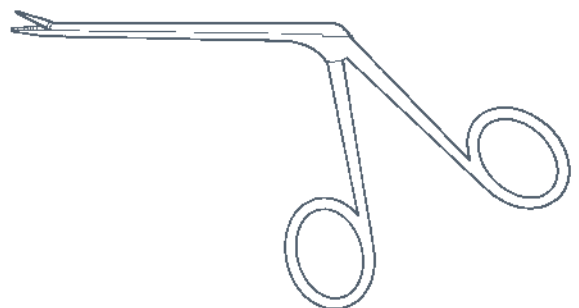

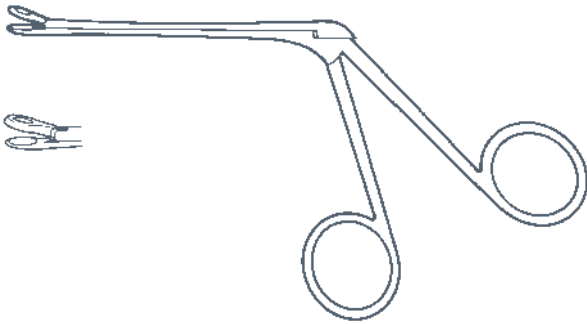

## AURAL FORCEPS

**Henckel**

crocodile, satin finish, scoop blades,  
75mm effective length

7050/05

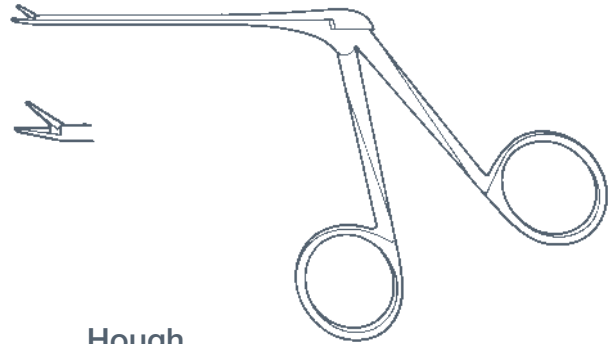
**Hough**

crocodile, satin finish, serrated jaws,  
70mm effective length

7056/05

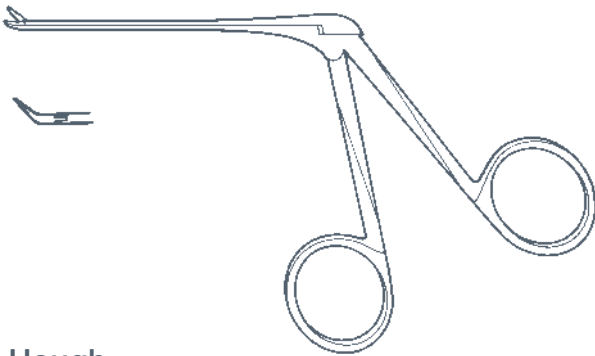
**Hough**

crocodile, satin finish, serrated jaws angled to right  
70mm effective length

7056/10

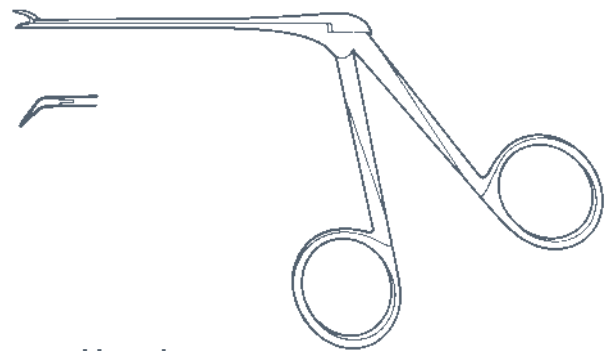
**Hough**

crocodile, satin finish, serrated jaws angled to left  
70mm effective length

7056/15

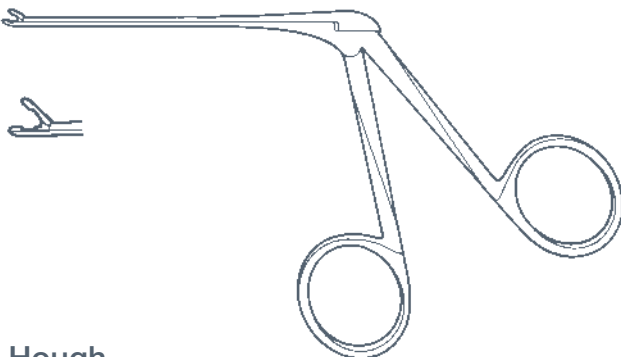
**Hough**

crocodile, satin finish, oval cup jaws  
70mm effective length

7056/20

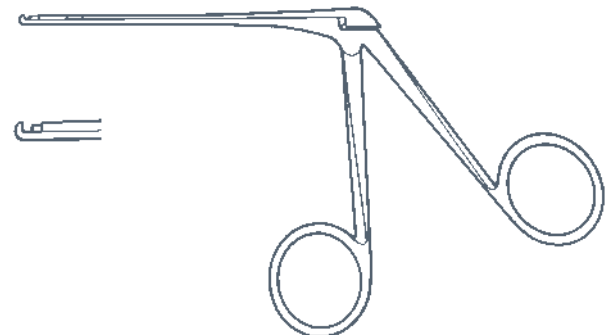
**House-Dieter Malleus**

fine, satin finish, 75mm effective length

7059/05



### AURAL FORCEPS

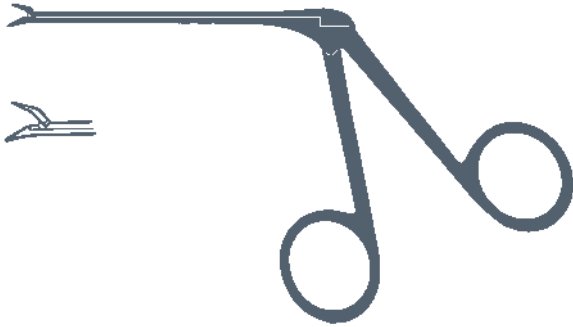

#### McGee

crocodile, black finish, wire closing  
70mm effective length  
7064/05

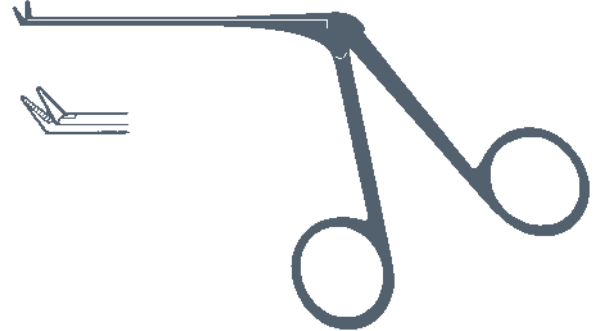

#### Ormerod

crocodile, black finish, extra fine serrated jaws,  
angled upwards 70mm effective length  
7065/05

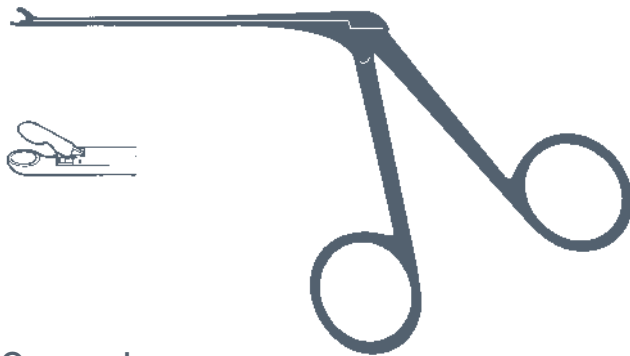

#### Ormerod

crocodile, black finish, fine circular cup jaws  
70mm effective length  
7065/10



#### Ormerod

crocodile, black finish, fine elongated cup jaws  
70mm effective length  
7065/15

#### Shea

crocodile, black finish, oval cup jaws

- 7071/05 straight, 70mm effective length
- 7071/10 curved to the left, 70mm effective length
- 7071/15 curved to the right, 70mm effective length
- 7071/20 curved upwards, 70mm effective length

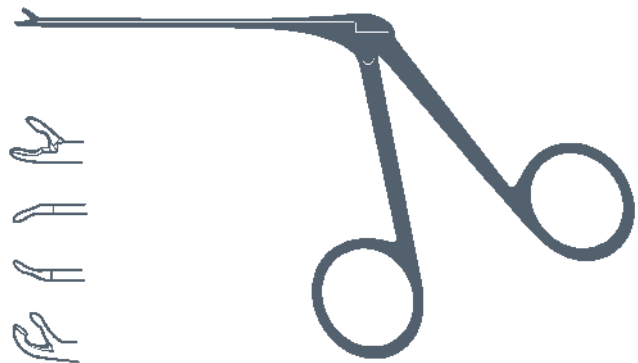



## AURAL FORCEPS

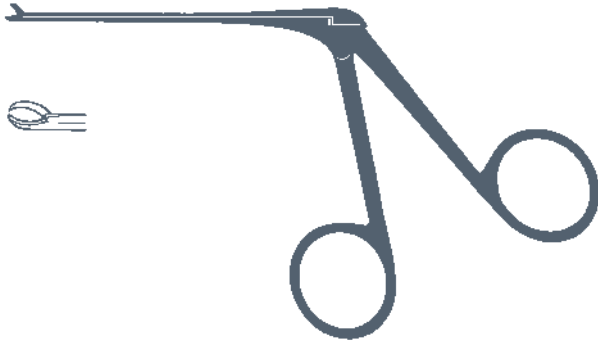

### Tabb Crura

crocodile, black finish  
75mm effective length  
7077/05

## AURAL DRESSING FORCEPS

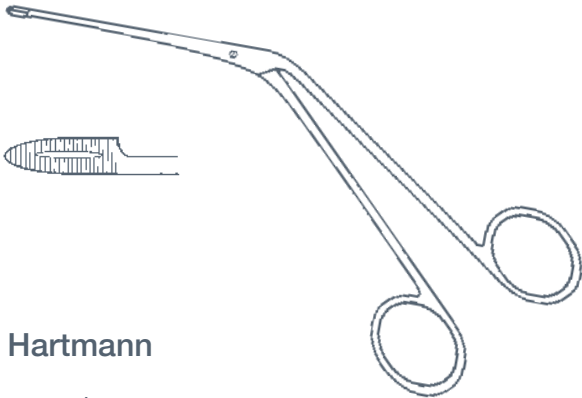

### Hartmann

serrated, screw joint 140mm  
7080/05

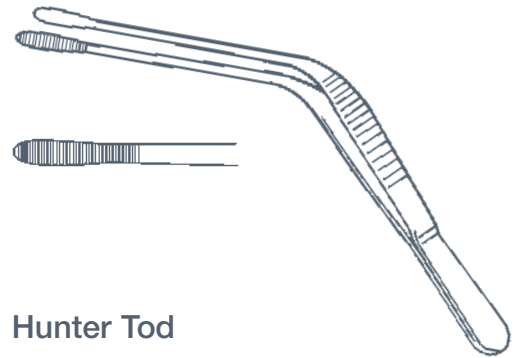

### Hunter Tod

serrated ends 110mm  
7081/05

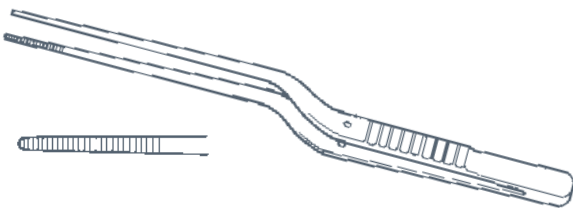

### Lucae

serrated ends 150mm  
7082/05

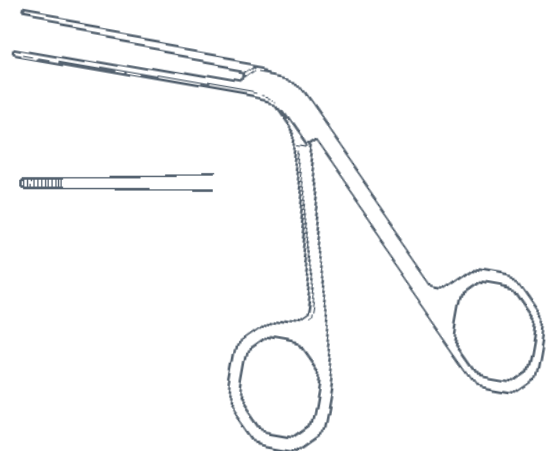

### Tilley

serrated ends 145mm  
7086/05



# AURAL DRESSING FORCEPS

## Wilde

1/2 teeth 135mm  
7088/05

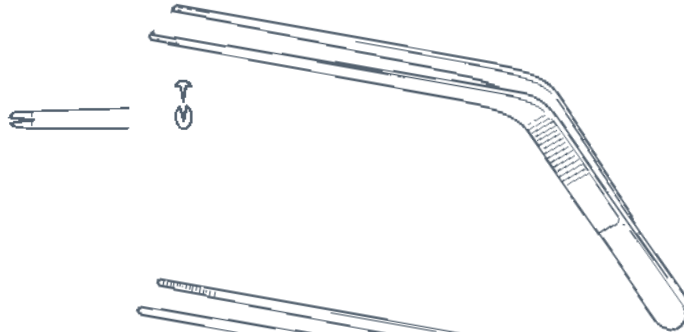

## Wilde

serrated ends 135mm  
7088/10

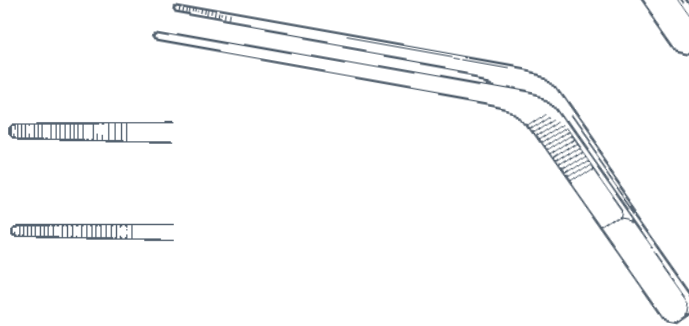

extra fine serrated ends 135mm  
7088/20



# AURAL INSTRUMENTS



## Cawthorne

Hook, black finish, 165mm  
7096/05 No. 1, slight curve



Hook, black finish, 165mm  
7096/30 No. 6,  
90° angle, 1mm



Hook, black finish, 165mm  
7096/10 No. 2, medium curve



Hook, black finish, 165mm  
7096/35 No. 7, retrograde



Hook, black finish, 165mm  
7096/15 No. 3, full curve



Hook, black finish, 165mm  
7096/40 No. 8,  
45° angle, 0.5mm



Hook, black finish, 165mm  
7096/20 No. 4, double curve



Hook, black finish, 165mm  
7096/45 No. 9, straight



Hook, black finish, 165mm  
7096/25 No. 5, 90° angle, 0.5mm



7096/95 set of 9 instruments



AURAL INSTRUMENTS

**Rosen**

Curette No. 5, black finish  
7105/05 160mm



Curette No. 6, black finish  
7105/10 160mm



Elevator No. 2, bayonet shaped,  
broad, black finish  
7105/15 190mm



Elevator No. 3, bayonet shaped,  
narrow, black finish  
7105/20 190mm



Elevator No. 4, black finish  
7105/25 160mm



Scoop No. 11, oval, straight, black finish, 160mm  
7105/55 size 000  
7105/60 size 00  
7105/65 size 0  
7105/70 size 1



Fenestrator, cross chequered  
handle, black finish  
7105/30 160mm

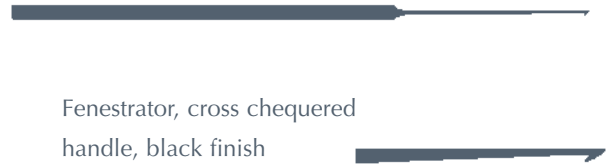

Knife No. 1, black finish  
7105/35 160mm

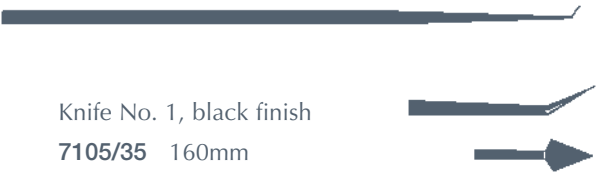

Mobiliser No. 8,  
black finish  
7105/40 160mm

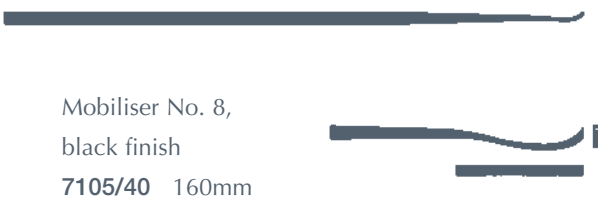

Mobiliser No. 9,  
black finish  
7105/45 160mm

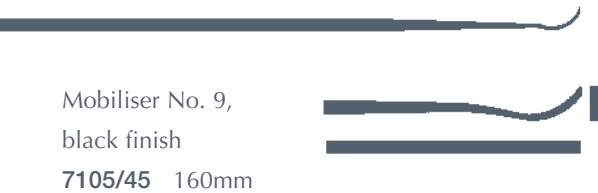

Probe, No. 7, footplate, black finish  
7105/50 160mm

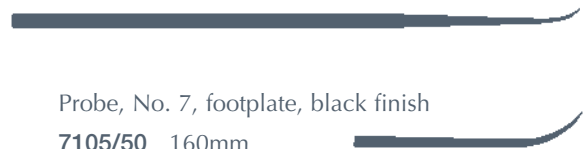



# AURAL INSTRUMENTS



## Schuknecht

Micro-Hook, black finish, 160mm  
7108/05 upward 4mm



Micro-Hook, black finish, 160mm  
7108/10 downward 4mm



Hook, black finish, 160mm  
7108/15 upward 7mm



Hook, black finish, 160mm  
7108/20 downward 7mm



Elevator, black finish, 160mm  
7108/25 oval window

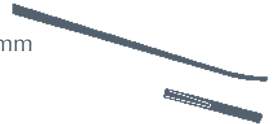

Hook, black finish, 160mm  
7108/30 right angled upward



Pick, black finish, 160mm  
7108/35 straight



Spatula, black finish, 160mm  
7108/40 straight

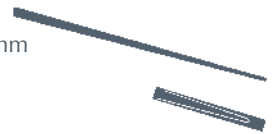

7108/95 set of 8 instruments

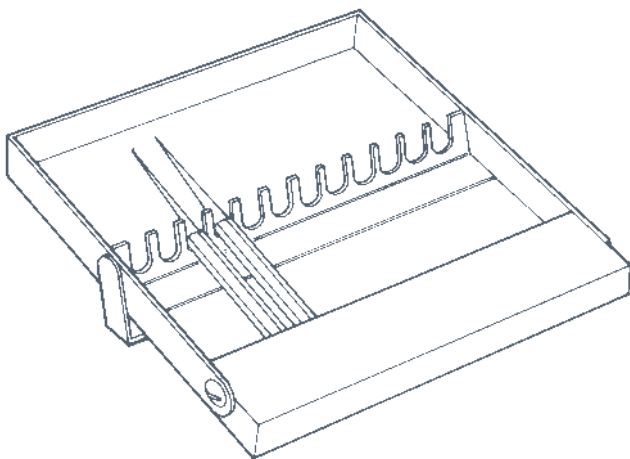

## Tray

racked to autoclave and carry straight instruments

7109/05 8 instrument

7109/10 12 instrument

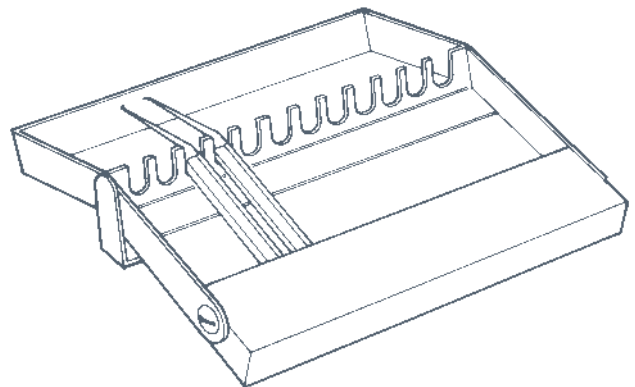

## Tray

racked to autoclave and carry angled instruments

7109/55 8 instrument

7109/60 12 instrument





## AURAL SNARE

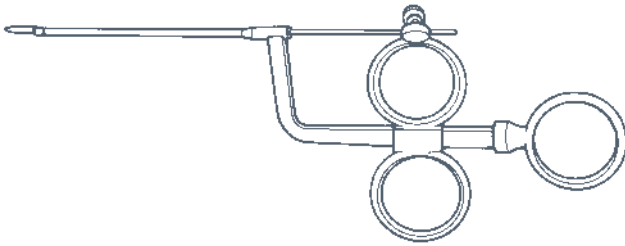

### Glegg

self-forming 165mm

7111/05

spare wire 36swg

7111/50

## AURAL SPECULA

### Rosen

unslotted, round ends, black finish, 35mm

7121/05 3mm diameter

7121/10 4mm diameter

7121/15 5mm diameter

7121/20 6mm diameter

7121/25 7mm diameter

7121/95 set of 5

### Siegle (Peters)

Otoscope with 5 ear specula, rubber tube and bulb

7127/05 complete

7127/55 spare speculum 6.5mm

7127/60 spare speculum 7.0mm

7127/65 spare speculum 8.0mm

7127/70 spare speculum 9.0mm

7127/75 spare speculum 10.0mm

### Tumarkin

tapered slot

7138/05 size 0, 4.5mm

7138/10 size 1, 6.5mm

7138/15 size 2, 7.0mm

7138/20 size 3, 7.5mm

7138/25 size 4, 8.0mm

7138/30 size 5, 8.5mm

7138/35 size 6, 9.0mm

7138/40 size 7, 11.0mm

7138/95 set of 8

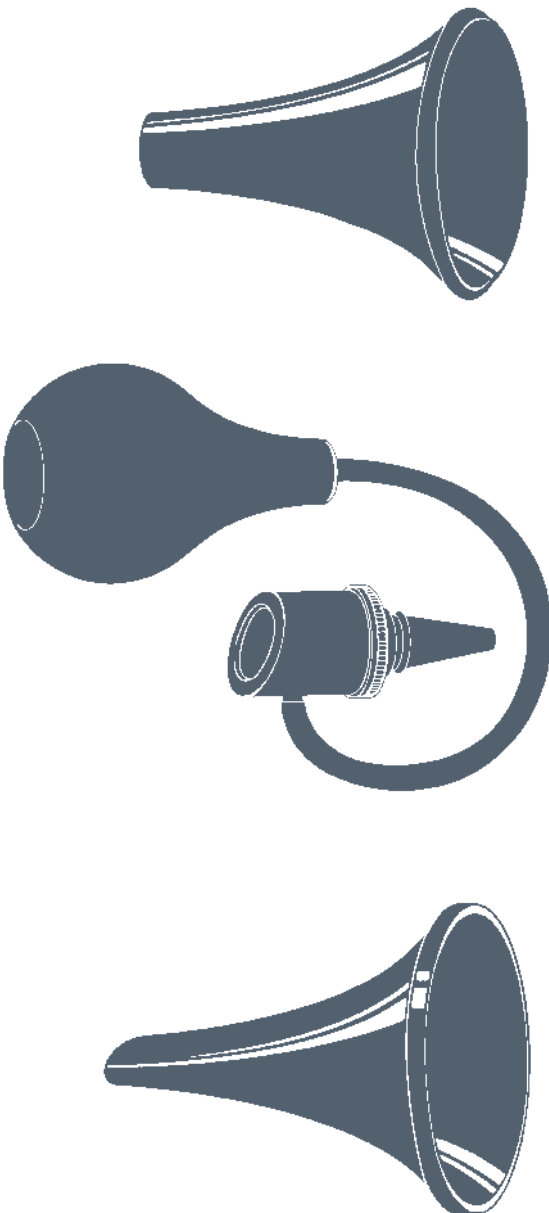



# BIOPSY FORCEPS

## Chevalier Jackson

basket jaw with round end

7145/05 280mm effective length

7145/10 550mm effective length



## Chevalier Jackson

basket lower jaw

7147/05 350mm effective length

7147/10 400mm effective length

7147/15 450mm effective length

7147/20 500mm effective length

7147/25 550mm effective length

7147/30 600mm effective length



## Paterson

7150/05 200mm effective length

7150/10 250mm effective length

7150/15 300mm effective length

7150/20 350mm effective length

7150/25 400mm effective length

7150/30 450mm effective length

7150/35 500mm effective length

7150/40 550mm effective length

7150/45 600mm effective length

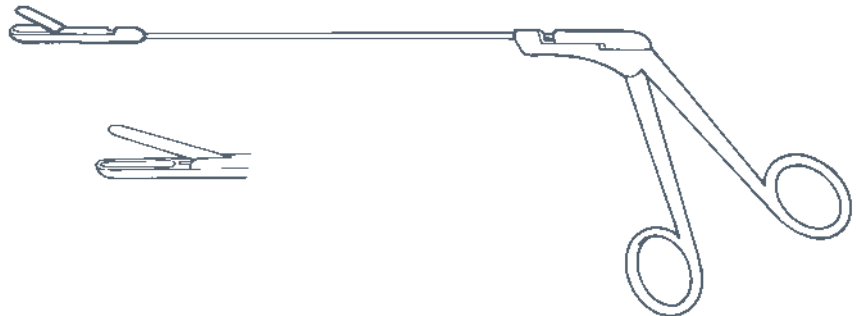

## Paterson

extra fine

7153/05 350mm effective length

7153/10 450mm effective length





BIPOD

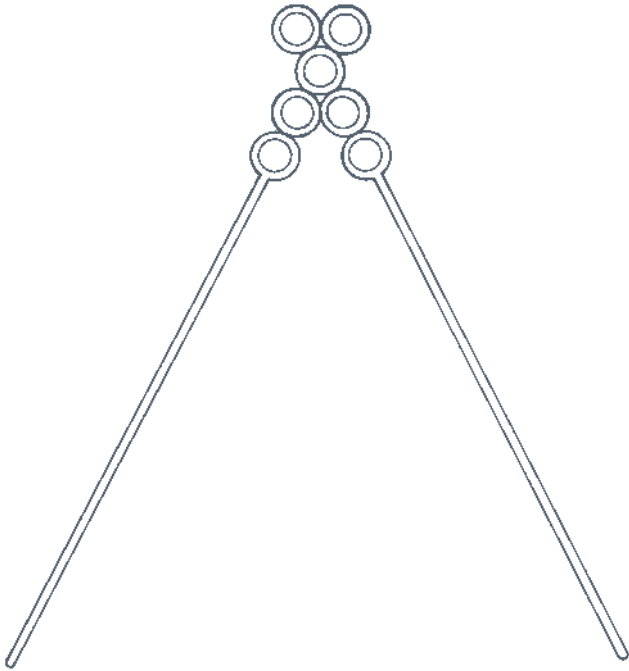

**Draffin**

480mm  
7160/05



**Magauran Plate**

to hold bipod  
7163/05

BURS

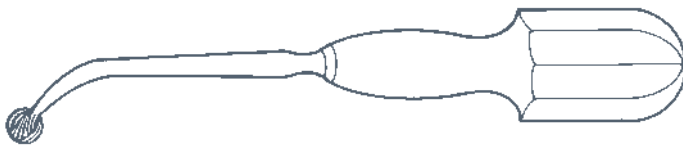

**Tilley**

170mm  
7190/05 6mm diameter  
7190/10 7mm diameter  
7190/15 8mm diameter

CATHETERS



**Woakes Eustachian**

silver, luer, 140mm  
7215/05 7fg, 2.3mm  
7215/10 8fg, 2.7mm  
7215/15 9fg, 3.0mm  
7215/20 10fg, 3.3mm  
7215/25 11fg, 3.7mm



# CERUMEN HOOKS

## Cawthorne

145mm  
7230/05



## Formby

175mm  
7233/05



## Lucae

140mm  
7236/05 small  
7236/10 medium  
7236/15 large



## St. Barts

blunt 175mm  
7239/05



# CONCHOTOMES

## Hartmann

circular cutting, 100mm  
7245/05 5mm diameter  
7245/10 7mm diameter  
7245/15 9mm diameter  
7245/20 11mm diameter

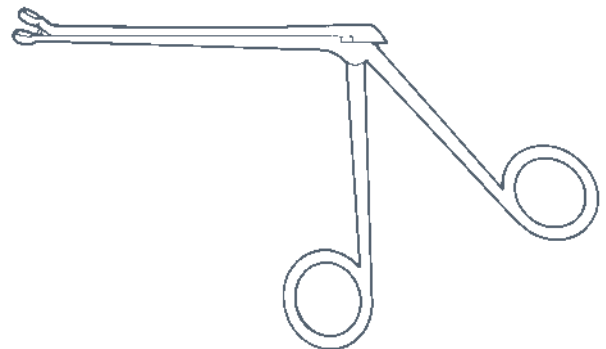

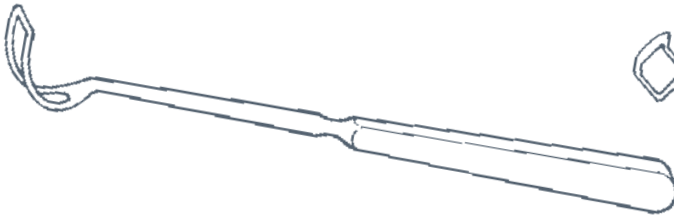

## CURETTES

**Barnhill**

length 215mm

7253/05 10mm

7253/10 14mm

7253/15 16mm

7253/20 18mm

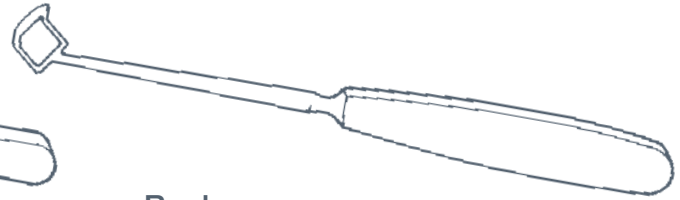
**Beckmann**

length 215mm

7256/05 8mm

7256/10 10mm

7256/15 12mm

7256/20 14mm

7256/25 16mm

7256/30 18mm

**House**

straight, double ended

7262/05 180mm

angled, double ended

7262/10 180mm

**Mackie**

length 195mm

7265/05 6mm diameter

7265/10 8mm diameter

7265/15 9mm diameter

**St Clair Thompson**

length 235mm

7268/05 8mm

7268/10 10mm

7268/15 12mm

7268/20 14mm

7268/25 16mm

7268/30 18mm

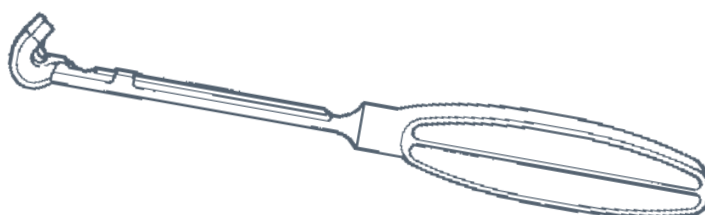



# DIATHERMY FORCEPS



### Remington Hobbs

insulated, serrated 250mm  
7320/25

insulated, 1/2 teeth 250mm  
7320/50

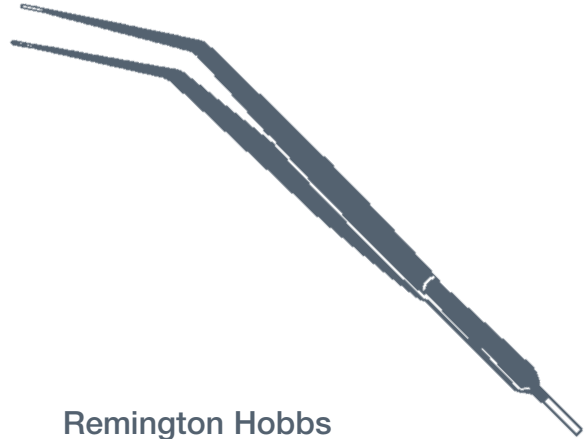

### Remington Hobbs

insulated, serrated, angled 250mm  
7320/75

# DISSECTORS

### Gwynne Evans

double ended, 195mm  
7325/05 6mm wide  
7325/10 8mm wide



### Hurd

double ended  
7328/05 195mm



### Mollison

double ended  
7331/05 210mm



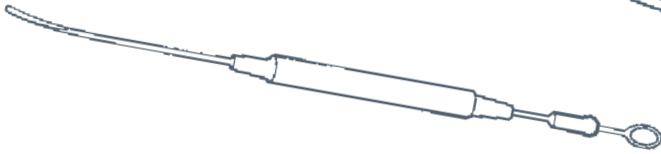

## DISSECTORS

**Negus Aspirating**

205mm  
7334/05

**St Clair Thompson**

blunt 160mm  
7343/05  
sharp 160mm  
7343/10

**Syme**

one blunt, one semi sharp end 180mm  
7346/05

## ELEVATORS

**Freer**

double ended, separator and elevator 200mm  
7350/05

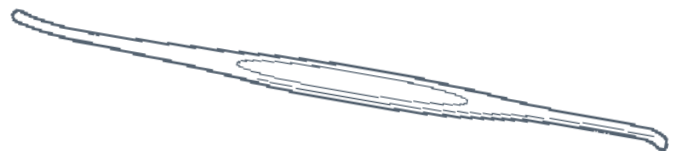
**Hill**

double ended, curved to side 220mm  
7353/05



# GOUGES

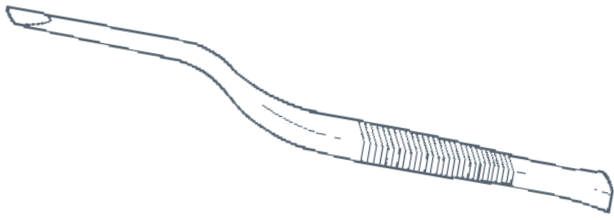

### Guy's

shallow groove length 125mm  
7370/05

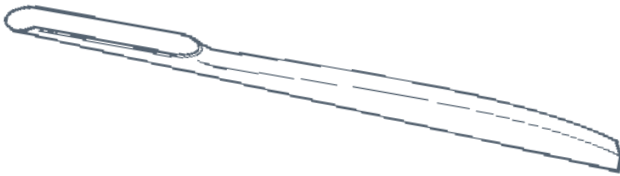

### Jenkins

length 140mm

7373/05 1mm

7373/10 2mm

7373/15 3mm

7373/20 4mm

7373/25 5mm

7373/30 6mm

7373/35 8mm

7373/40 10mm

7373/45 12mm

7373/50 14mm

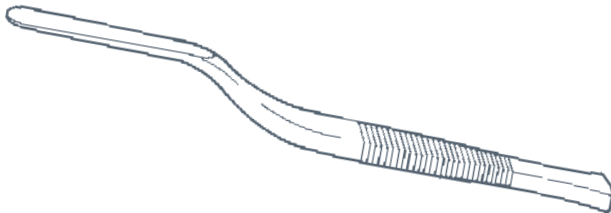

### Killian

length 125mm  
7376/05

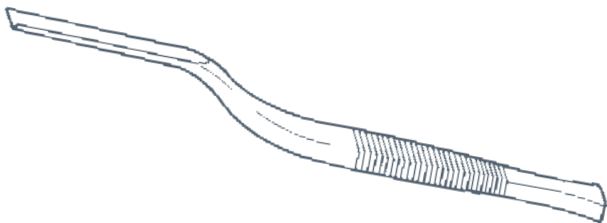

### Tilley

length 125mm  
7379/05





## KNOT TIER AND PUSHER



### Negus

7430/05 200mm

## LARYNGEAL FORCEPS



### Chevalier Jackson

alligator jaw

7435/05 300mm effective length

7435/10 350mm effective length

7435/15 400mm effective length

7435/20 450mm effective length

7435/25 550mm effective length

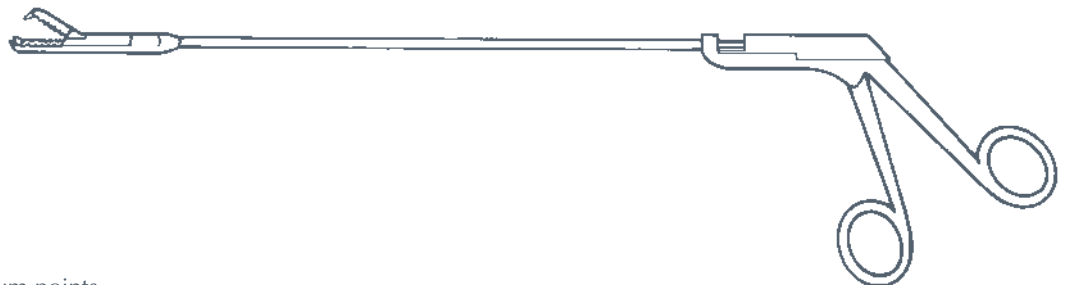
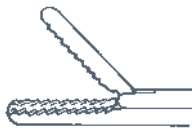

### Irwin Moore

alligator jaw, tenaculum points

7440/05 300mm effective length

7440/10 350mm effective length

7440/15 400mm effective length

7440/20 550mm effective length





# LARYNGEAL FORCEPS

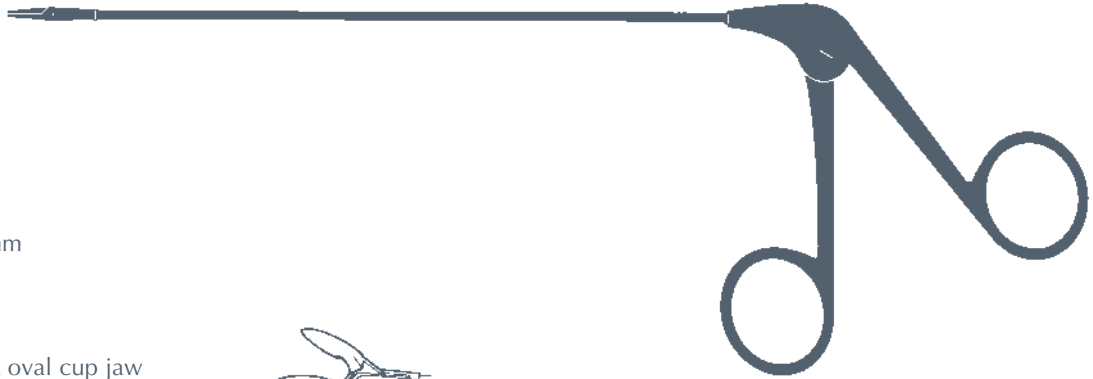

## Micro

black finish 250mm

7441/05 straight oval cup jaw



7441/10 straight round cup jaw



7441/15 curved to left round cup jaw



7441/20 curved to right round cup jaw



7441/25 curved upwards round cup jaw



7441/30 straight scissor type jaw



7441/35 curved to right scissor type jaw



7441/40 curved to left scissor type jaw



7441/45 horizontal scissor type jaw



7441/50 curved upwards scissor type jaw



7441/55 straight serrated jaw



7441/60 curved to right serrated jaw



7441/65 curved to left serrated jaw



7441/70 horizontal serrated jaw



7441/75 straight blakesley jaw





## MIRRORS

**Handle, Laryngeal**

for use with Laryngeal mirrors 95mm

7515/05

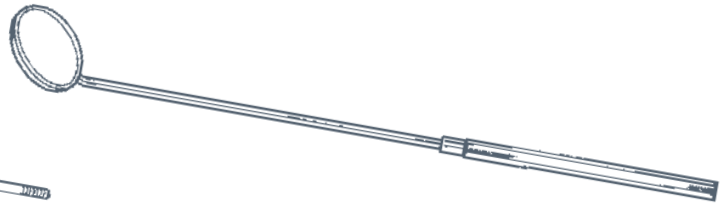
**Laryngeal**

without handle, 130mm

<b>7517/05</b>	6mm diameter
<b>7517/10</b>	8mm diameter
<b>7517/20</b>	10mm diameter
<b>7517/25</b>	12mm diameter
<b>7517/30</b>	14mm diameter
<b>7517/35</b>	16mm diameter
<b>7517/40</b>	18mm diameter
<b>7517/45</b>	20mm diameter
<b>7517/50</b>	22mm diameter
<b>7517/55</b>	24mm diameter
<b>7517/60</b>	26mm diameter
<b>7517/65</b>	28mm diameter
<b>7517/70</b>	30mm diameter

**Laryngeal Mirror**

complete with metal handle

<b>7519/05</b>	6mm diameter
<b>7519/10</b>	8mm diameter
<b>7519/20</b>	10mm diameter
<b>7519/25</b>	12mm diameter
<b>7519/30</b>	14mm diameter
<b>7519/35</b>	16mm diameter
<b>7519/40</b>	18mm diameter
<b>7519/45</b>	20mm diameter
<b>7519/50</b>	22mm diameter
<b>7519/55</b>	24mm diameter
<b>7519/60</b>	26mm diameter
<b>7519/65</b>	28mm diameter
<b>7519/70</b>	30mm diameter

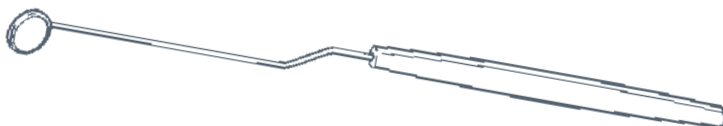
**St. Clair Thompson Rhinoscope**

<b>7525/05</b>	size 6
<b>7525/10</b>	size 8
<b>7525/15</b>	size 10
<b>7525/20</b>	size 12
<b>7525/25</b>	size 14
<b>7525/30</b>	size 16



# MOUTH GAGS

## Doyen

- 7529/05 adult
- 7529/10 child

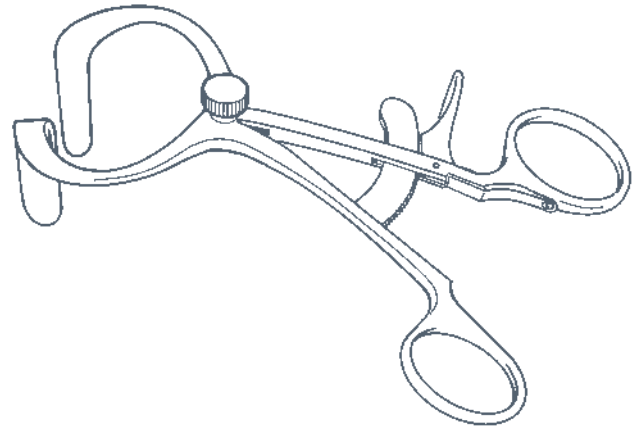

## Davis-Boyle

- frame only
- 7535/05 adult
- 7535/10 child

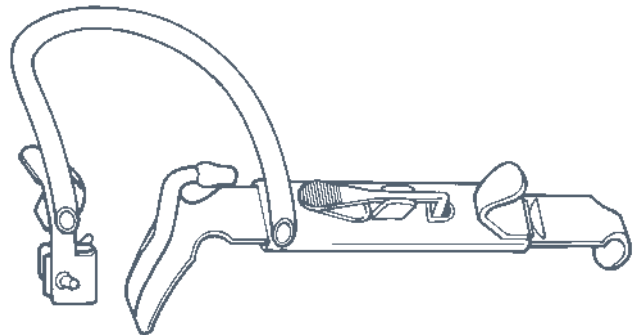

## Tongue Plates

- plain
- 7536/05 fig. 1 65mm
- 7536/10 fig. 2 75mm
- 7536/15 fig. 3 90mm
- 7536/20 fig. 4 100mm

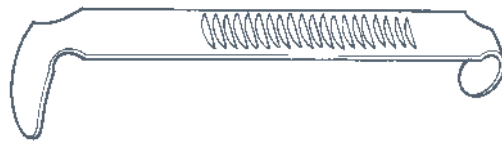

## Tongue Plates

- slotted
- 7537/05 fig. 1 65mm
- 7537/10 fig. 2 75mm
- 7537/15 fig. 3 90mm
- 7537/20 fig. 4 100mm
- 7537/25 fig. 5 115mm

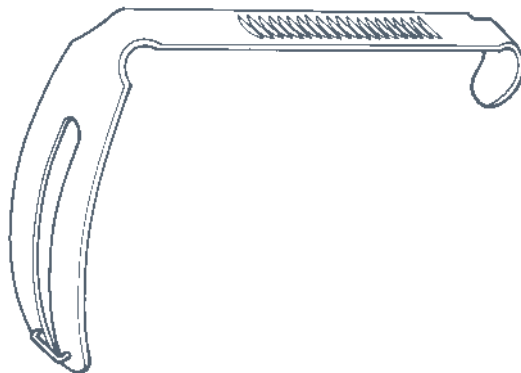

## Tongue Plates

- with anaesthetic tube
- 7540/05 fig. 1 65mm
- 7540/10 fig. 2 75mm
- 7540/15 fig. 3 90mm
- 7540/20 fig. 4 100mm
- 7540/25 fig. 5 115mm

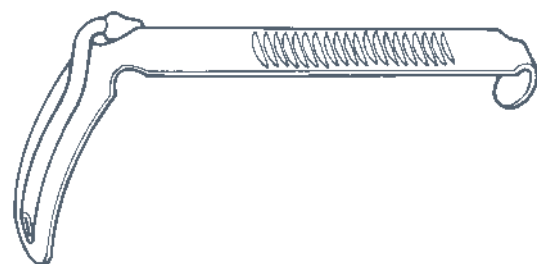



## MYRINGOTOMES



### Agnew

190mm  
7545/05



### Politzer

reversing into handle, adjustable 170mm  
7548/05



### Trautmann

downward cutting 175mm  
7551/25



### Trautmann

upward cutting 175mm  
7551/50

## NASAL FORCEPS

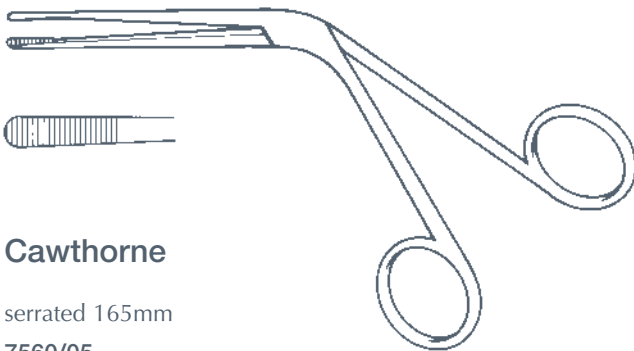

### Cawthorne

serrated 165mm  
7560/05

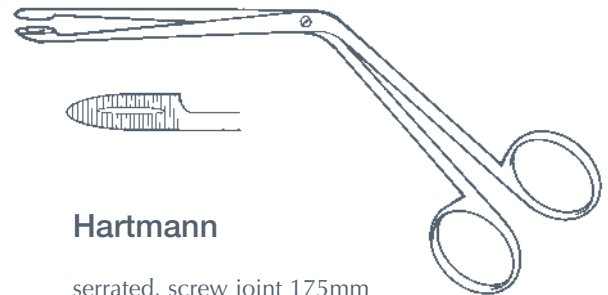

### Hartmann

serrated, screw joint 175mm  
7563/05

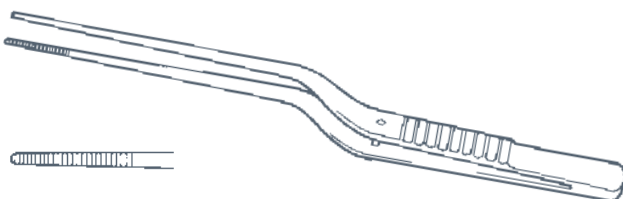

### Lucae

serrated 160mm  
7564/05

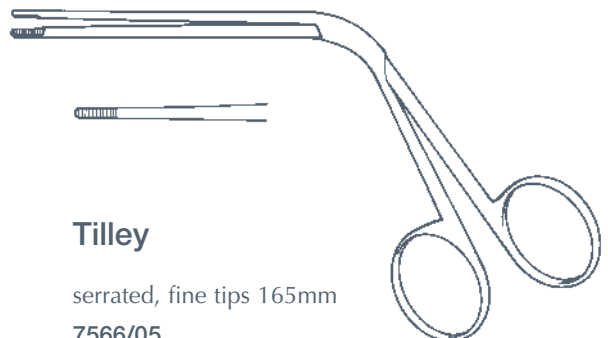

### Tilley

serrated, fine tips 165mm  
7566/05



# NASAL INSTRUMENTS



## Freer

Knife, rounded edge  
7580/05 190mm



Elevator, dull edge  
7580/25 190mm



Knife, flat rounded blade  
7580/10 190mm



Knife, curved to side  
7580/30 190mm



Knife, rounded blade curved on flat  
7580/15 190mm



Chisel  
7580/35 190mm



Elevator, sharp edge  
7580/20 190mm



## House Measuring Rods

black finish, 160mm  
7583/05 3.5mm



black finish, 160mm  
7583/15 4.5mm



black finish, 160mm  
7583/10 4.0mm



black finish, 160mm  
7583/20 5.0mm



## Hughes Stapes Mobiliser

black finish  
7586/05 165mm





## NASAL KNIVES

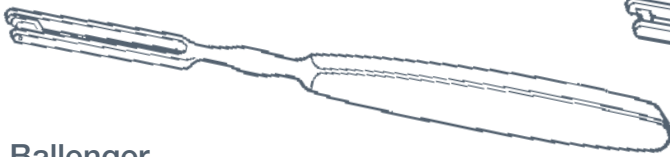

### Ballenger

straight, 200mm

7590/05 6mm wide

7590/10 8mm wide



### Ballenger

cranked, 195mm

7591/05 6mm wide

## NASAL RASP

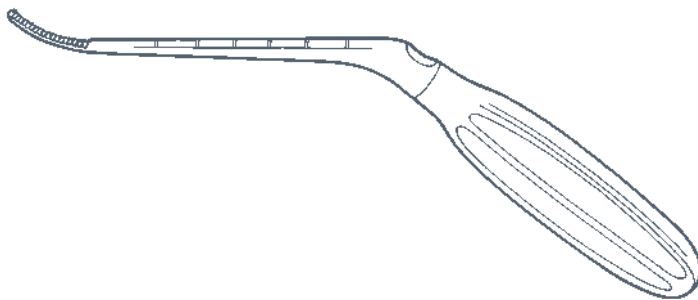

### Watson-Williams

rounded with convex blade,  
small 170mm

7605/05

rounded with convex blade,  
large 170mm

7605/10

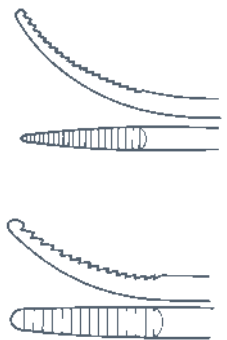

## NASAL SNARE

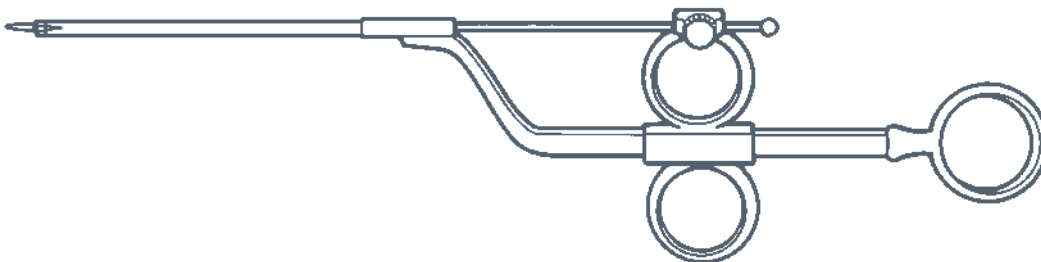

### Glegg

self looping 235mm

7610/05

spare wire 28swg

7610/50



# NASAL SNARE

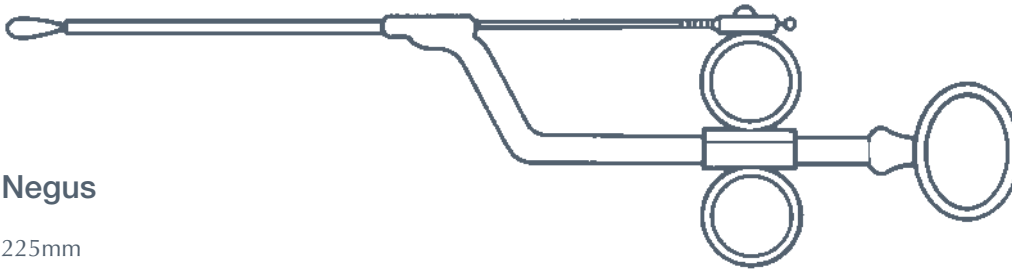

## Negus

225mm  
7613/05

# NASAL SPECULA

## Killian

plain

- 7623/05 blade 50mm
- 7623/10 blade 55mm
- 7623/15 blade 65mm
- 7623/20 blade 75mm
- 7623/25 blade 90mm

insulated

- 7626/03 blade 50mm
- 7626/05 blade 55mm
- 7626/08 blade 65mm
- 7626/10 blade 75mm
- 7626/15 blade 90mm

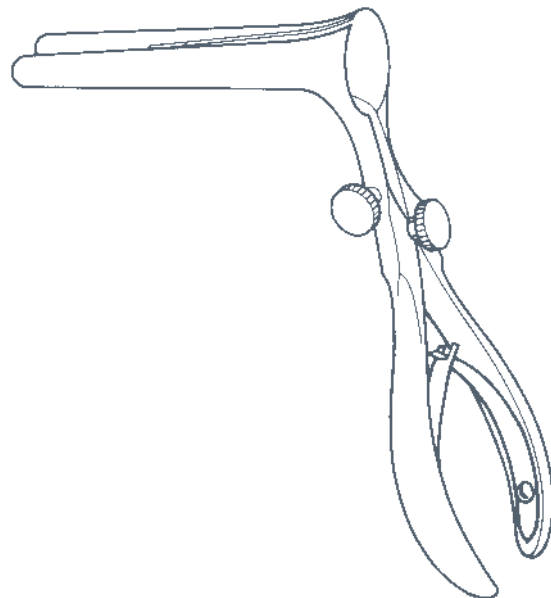

## St Clair Thompson

- 7629/05 blade 38mm
- 7629/10 blade 50mm
- 7629/15 blade 65mm
- 7629/20 blade 75mm
- 7629/95 set of 4

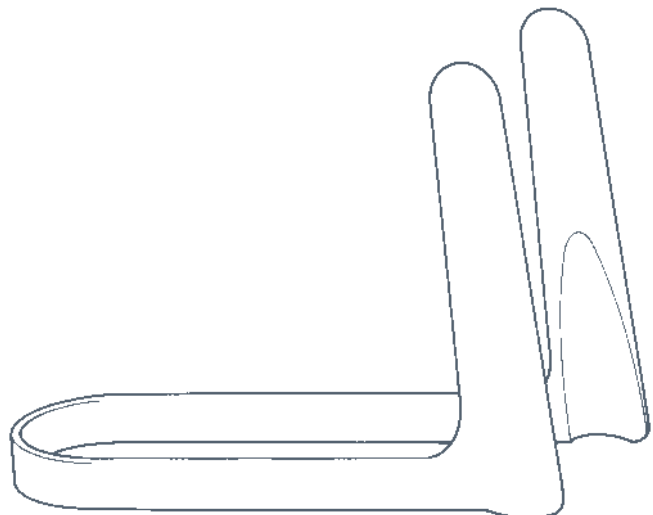





## NASAL SPECULA

### Thudichum

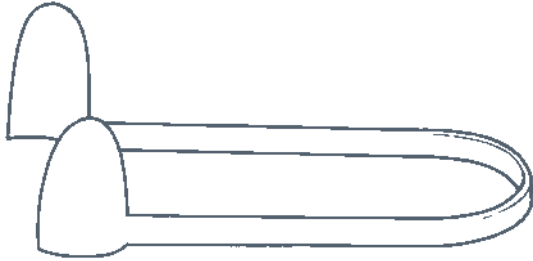

70mm		insulated, 70mm	
7632/05	size 1	7635/05	size 1
7632/10	size 2	7635/10	size 2
7632/15	size 3	7635/15	size 3
7632/20	size 4	7635/20	size 4
7632/25	size 5	7635/25	size 5
7632/30	size 6	7635/30	size 6
7632/35	size 7	7635/35	size 7
7632/95	set of 7	7635/95	set of 7

## NIBBLING FORCEPS

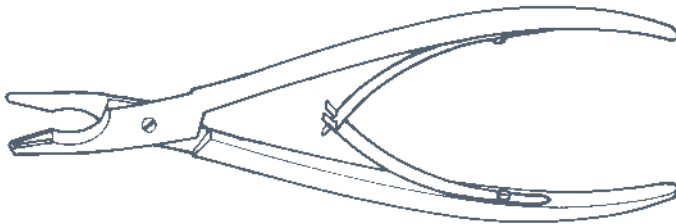

### Lempert

straight, screw joint

7640/05 150mm, 2.5mm jaw

## NODULE FORCEPS

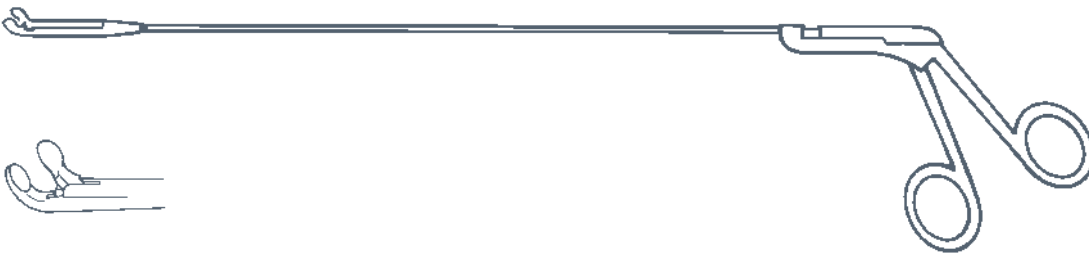

### Chevalier Jackson

upward cup

7645/05 280mm effective length

7645/10 350mm effective length

7645/15 400mm effective length

7645/20 500mm effective length

7645/25 550mm effective length



## NOISE APPARATUS

**Barany**

7650/05

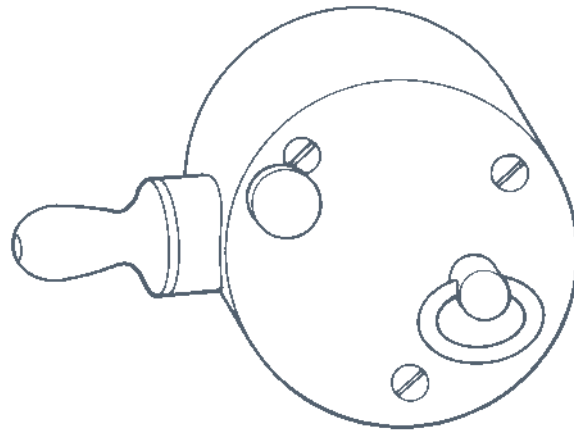

## PALATE LEVER

**Angell James**

225mm

7655/05

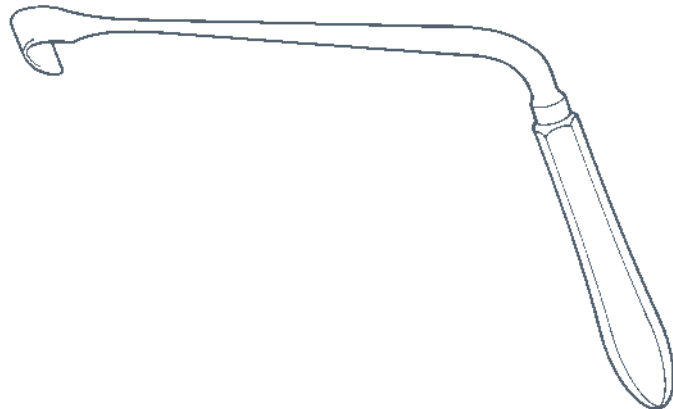

## PERFORATORS

**Myles**

170mm

7660/05 16fg, 5.3mm

7660/10 19fg, 6.3mm

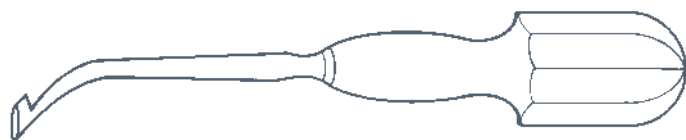



## PITUITARY FORCEPS

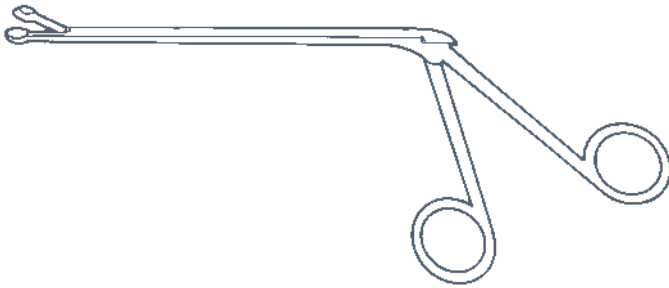

### Bateman

crocodile jaws, fenestrated

7665/05 150mm effective length



### Wilson

flattened tip, 3mm bite

7668/05 145mm effective length

## PROBES



### Jobson Horne

double ended

7675/05 140mm

7675/10 175mm

## PUNCH FORCEPS

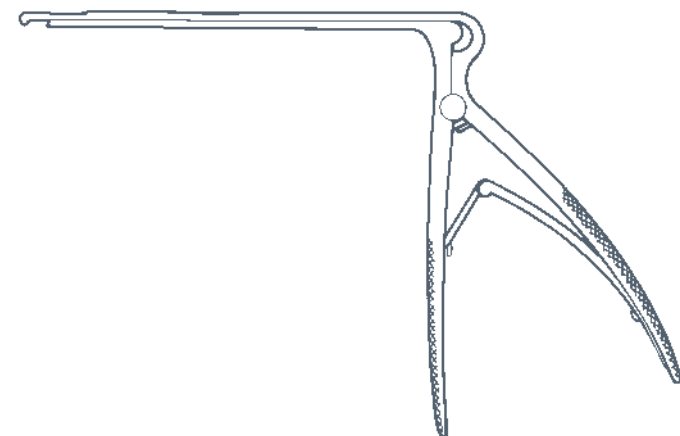

### Angell James

downward cutting, 150mm effective length 2mm

60° bite

7685/05



downward cutting, 150mm effective length 2mm

right angle bite

7685/10



upward cutting, 150mm effective length 2mm 60°

bite

7685/15



upward cutting, 150mm effective length 2mm

right angle bite

7685/20





# PUNCH FORCEPS

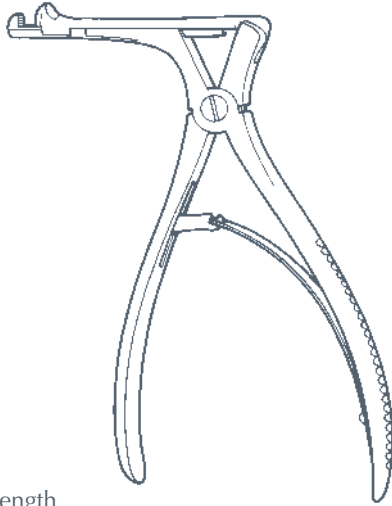

### Citelli

73mm effective length  
7688/05 2mm bite  
75mm effective length  
7688/10 4mm bite

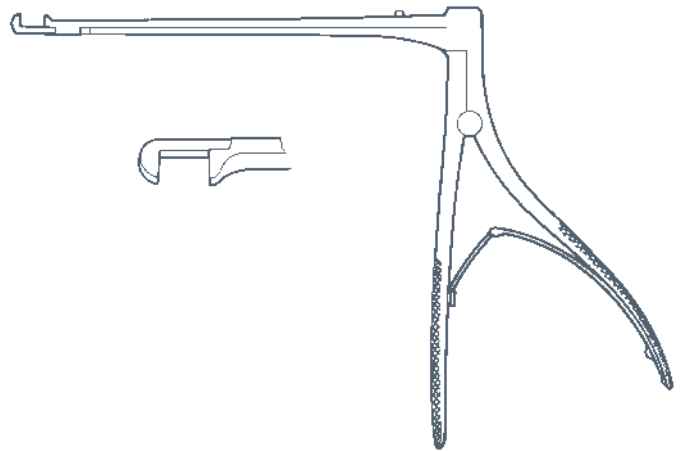

### Hajek Sphenoidal

upward cutting, 145mm effective length  
7700/05 4mm bite  
7700/10 5mm bite  
downward cutting, 145mm effective length  
7700/15 4mm bite  
7700/20 5mm bite

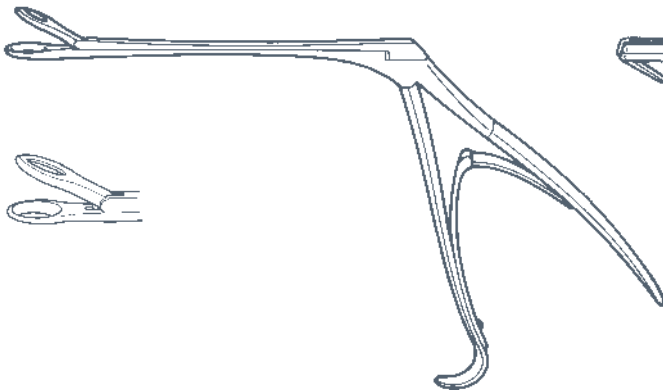

### Henckel

spring action  
7701/05 115mm effective length

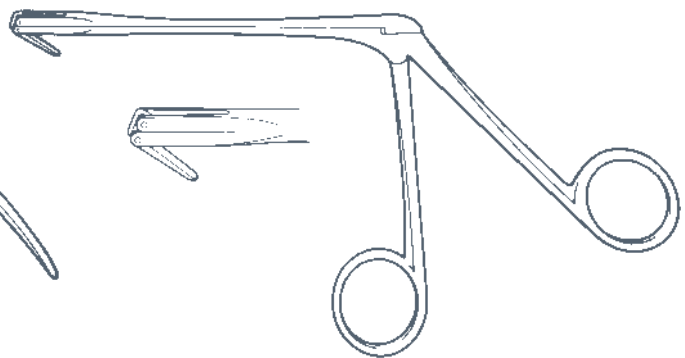

### Ostrom

reverse action  
7703/05 175mm effective length



PUNCH FORCEPS

**St Bartholomew's**

scoop blades, 112mm effective length

7706/05 straight, 3mm bite

7706/10 upward cutting, 3mm bite

7706/15 downward cutting, 3mm bite

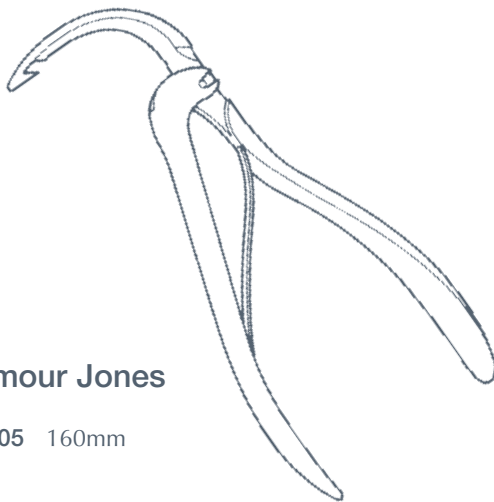
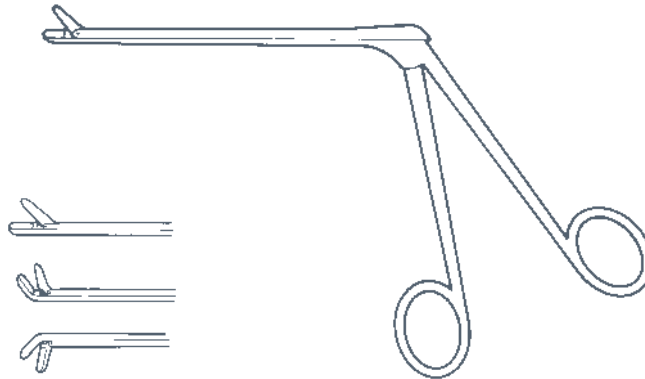

**Seymour Jones**

7709/05 160mm

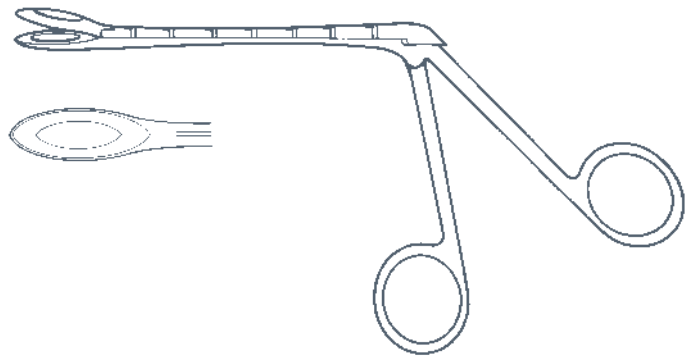

**Tilley Henckel**

112mm effective length

7712/05 4.5mm bite

7712/10 5.5mm bite

7712/15 6.5mm bite

7712/20 8.0mm bite

RETRACTORS

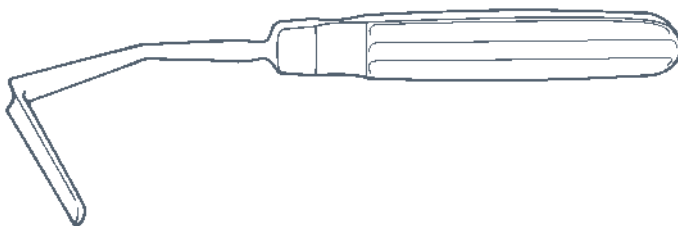

**Aufricht**

7720/05 160mm



### RETRACTORS, SELF-RETAINING



**Mollison**

curved, 2/2 teeth  
7726/05 135mm

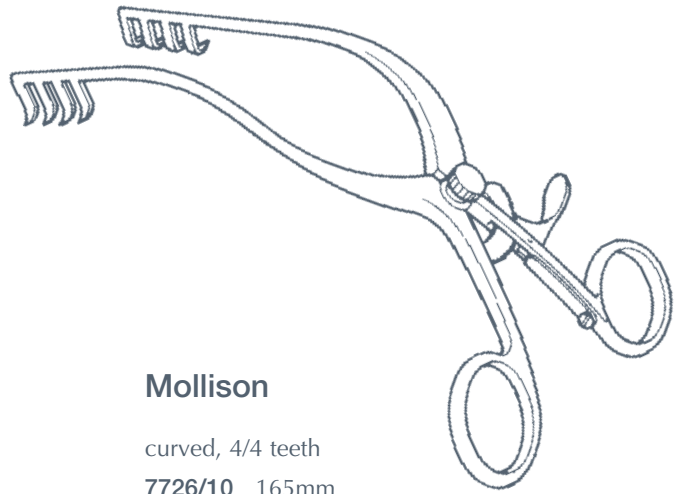

**Mollison**

curved, 4/4 teeth  
7726/10 165mm

### RUGINES

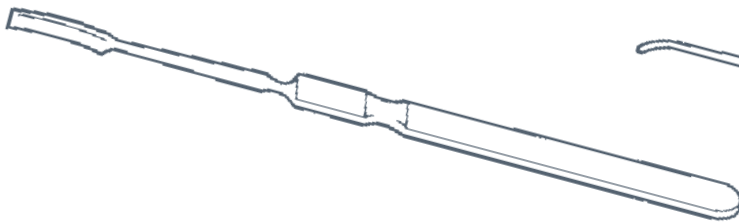

**Lempert**

broad  
7729/25 170mm

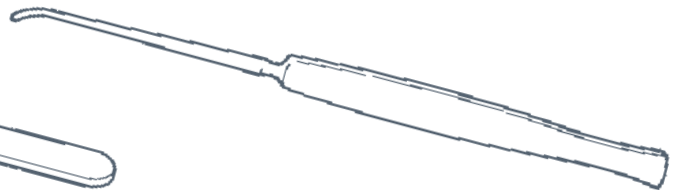

**Lempert**

narrow  
7729/50 155mm

### SCISSORS

**Cawthorne**

crocodile, black finish, extra fine  
70mm effective length  
7740/05





SCISSORS

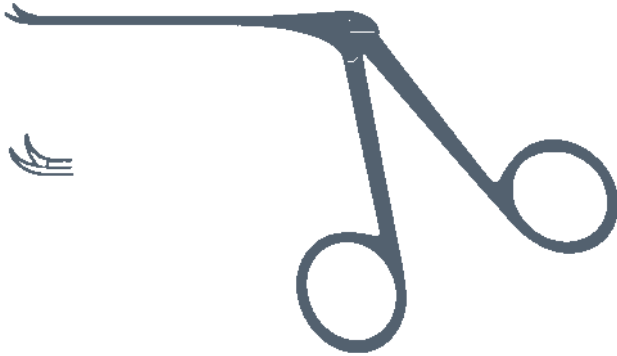

**Ormerod**

crocodile, black finish, extra fine,  
curved upwards 70mm effective length  
7743/05

**Portmann**

crocodile, satin finish, 70mm effective length  
curved to the left  
7746/25

crocodile, satin finish, 70mm effective length  
curved to the right  
7746/50

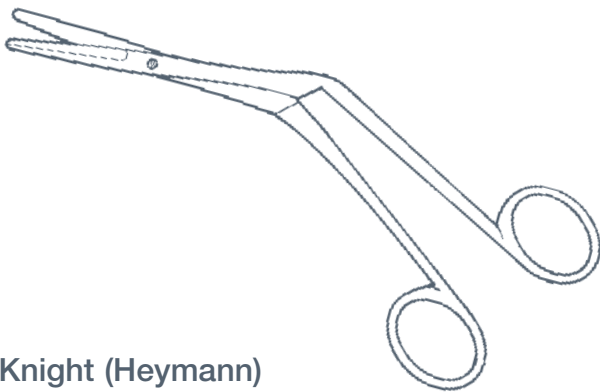
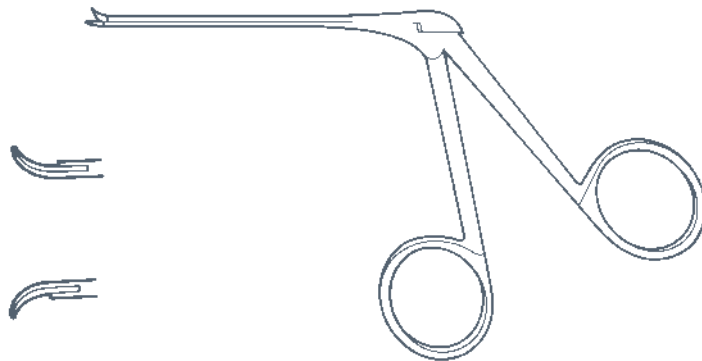

**Knight (Heymann)**

175mm  
7755/05

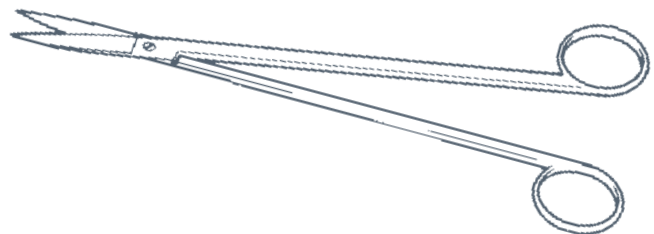

**Scott Stevenson Tonsil**

215mm  
7758/05

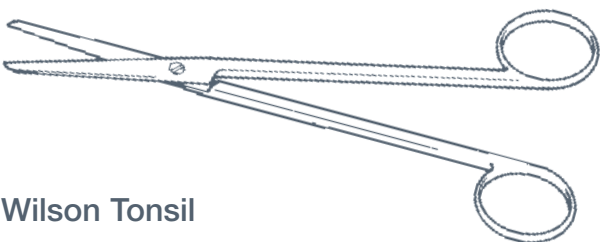

**Wilson Tonsil**

200mm  
7761/05

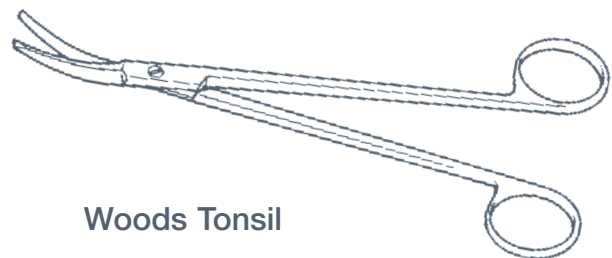

**Woods Tonsil**

190mm  
7764/05



## SCOOPS

### Lempert

oval, 200mm

7770/10 No. 000

7770/15 No. 00

7770/20 No. 0

7770/25 No. 1

7770/30 No. 2

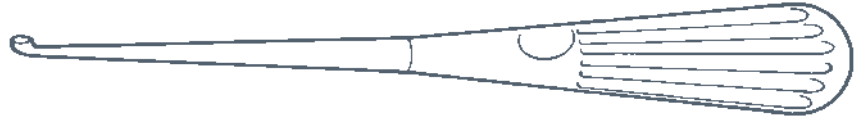

## SUCTION TUBES

### Barron

225mm

7780/08 4fg, 1.3mm

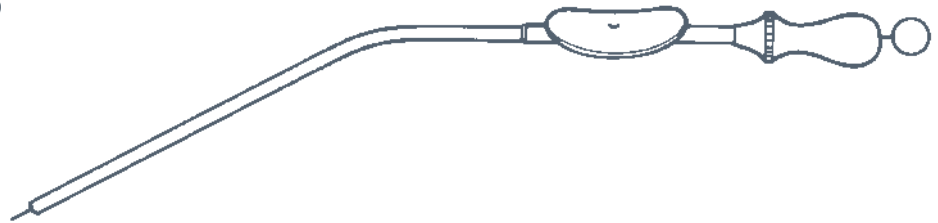

### Bellucci

170mm, complete with three detachable ends, 20, 22 and 24swg

7781/05 6fg

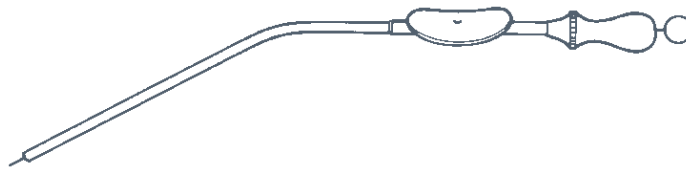

### Formby

conical tip, 210mm

7783/05 10fg, 3.3mm

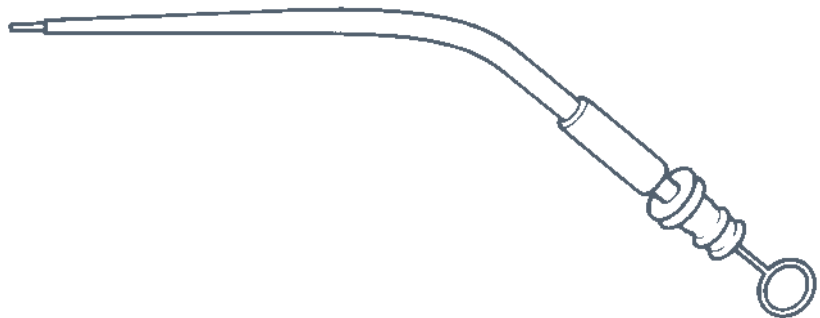

### House

125mm

7786/05 16swg x 18swg

7786/10 18swg x 20swg

7786/15 20swg x 22swg

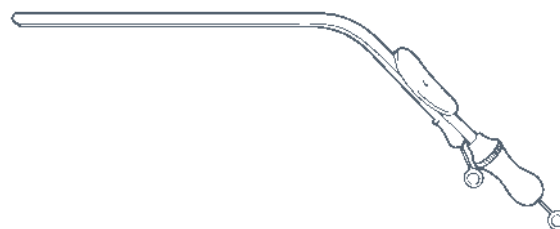





## SUCTION TUBES

**Lempert**

with stilette, 200mm

7792/05 6fg, 2mm

7792/10 9fg, 3mm

**Magill**

with stilette, 210mm

7796/05 3.0mm

7796/10 3.5mm

7796/15 4.0mm

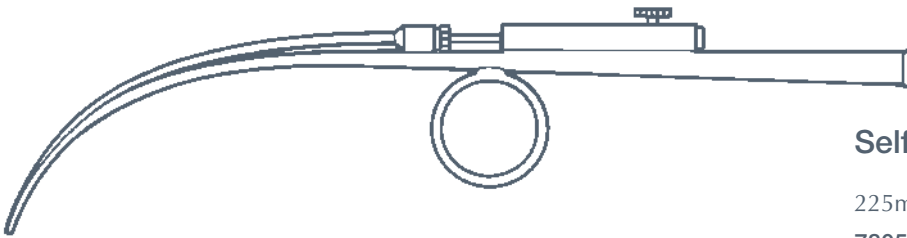
**Self-Clearing**

225mm

7805/05 1.5mm

7805/10 2.0mm

7805/15 3.0mm

**Cut-Out Adaptor**

7807/05 38mm

**Verhoeven**

luer, 100mm

7808/05 16swg

7808/10 18swg

7808/15 20swg

7808/20 22swg

7808/25 24swg



## SUCTION TUBES

### Zoellner

tube with stilette  
7811/05 175mm



detachable ends  
7812/05 18swg  
7812/10 20swg  
7812/15 22swg  
7812/20 24swg  
7812/25 26swg



## SYRINGE

### Aural

metal syringe complete with 2 tips, made in Pakistan  
7820/05 50ml  
7820/15 100ml

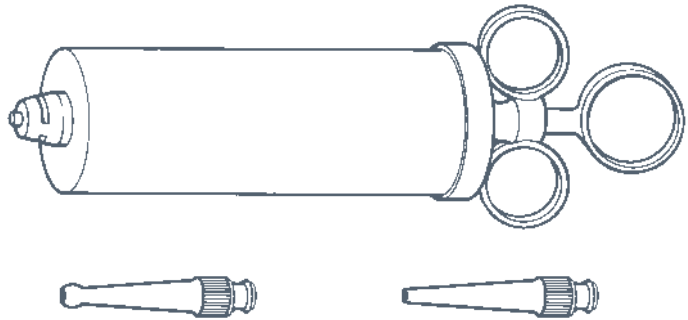

### Bacon Aural

7825/05 920mm

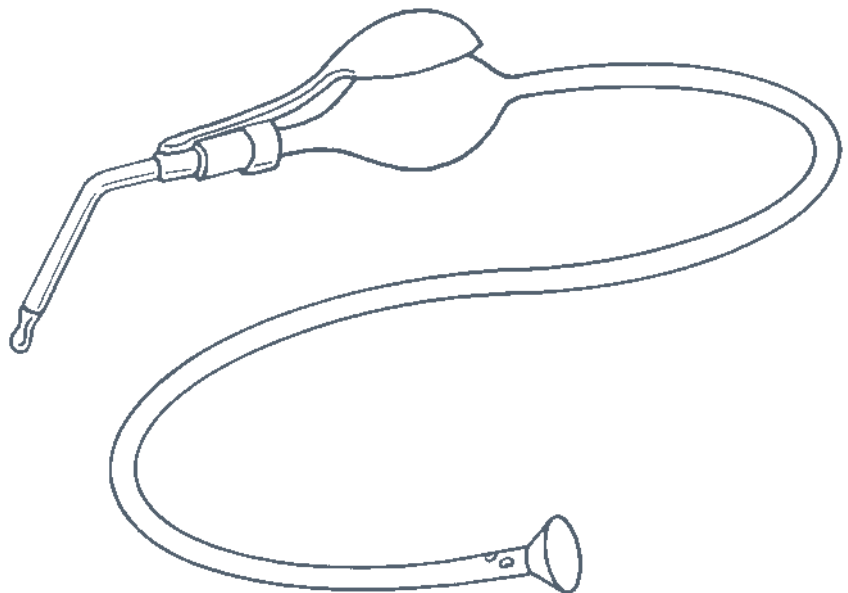



## TONGUE DEPRESSORS



### Flat

185mm  
7838/05

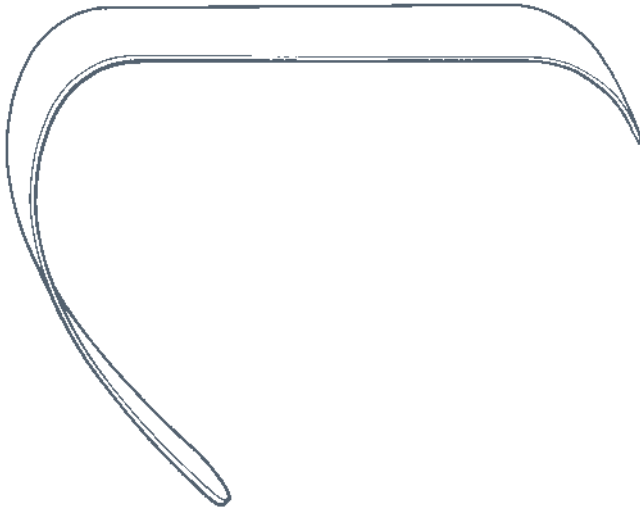

### Lack

child 12mm  
7841/05

adolescent 19mm  
7841/10

adult 22mm  
7841/15

## TONGUE FORCEPS

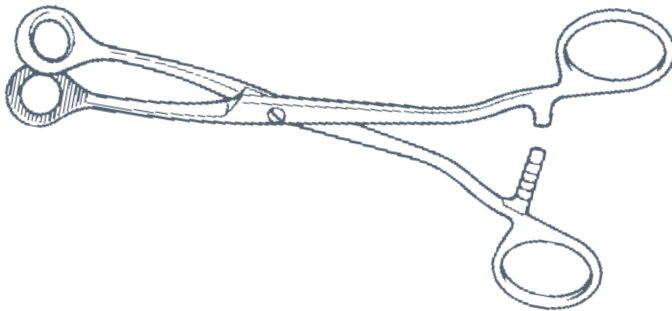

### Collin

screw joint 160mm  
7850/05

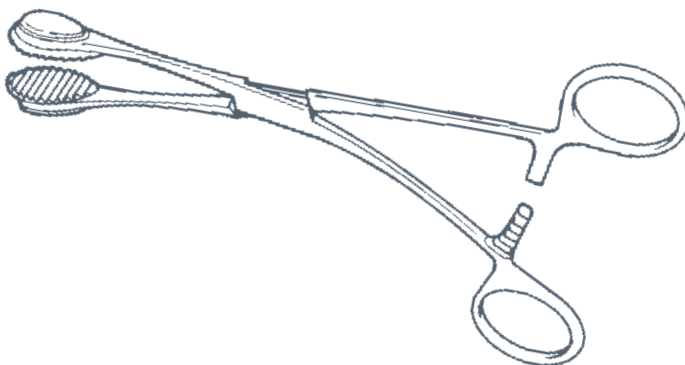

### Young

170mm  
7853/05



## TONSIL HOLDING FORCEPS

### Denis Browne

with rack 200mm

7860/25

without rack 200mm

7860/50

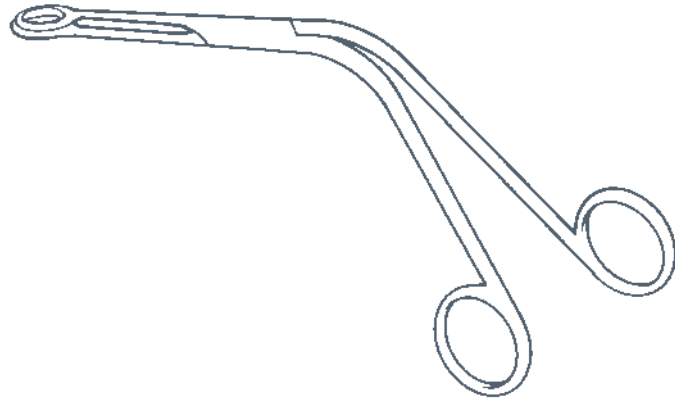

## TONSIL SNARE

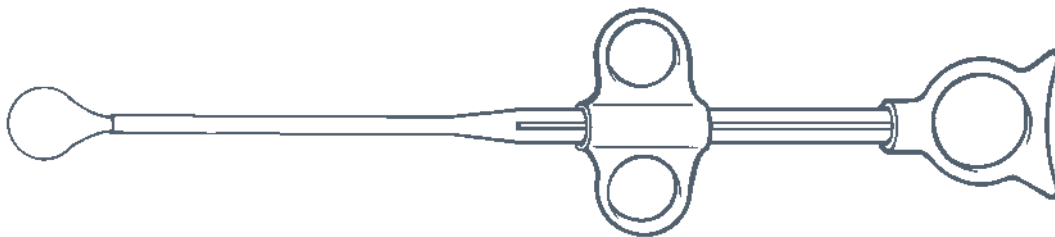

### Eve

275mm

7875/05

spare wire 25swg

7875/50

## TRACHEAL DILATORS

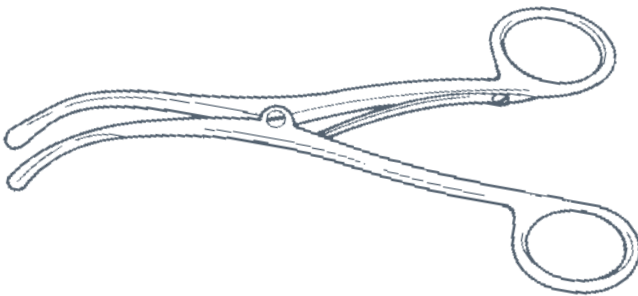

### Trousseau (Bowlby)

adult 140mm

7888/05

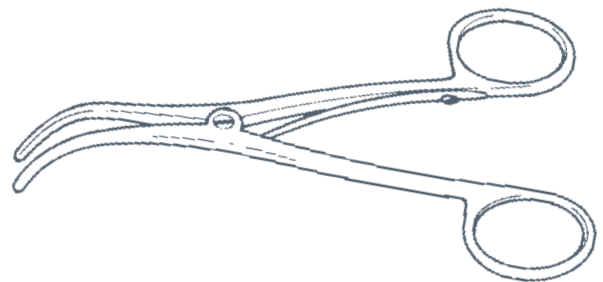

### Trousseau (Bowlby)

child 125mm

7888/10



## TRACHEOSTOMY TUBES

## Chevalier Jackson

Silver plated with one inner tube and pilot

- 7895/05 12fg
- 7895/07 14fg
- 7895/13 16fg
- 7895/15 18fg
- 7895/17 20fg
- 7895/23 22fg
- 7895/25 24fg
- 7895/27 26fg
- 7895/33 28fg
- 7895/35 30fg
- 7895/37 32fg
- 7895/43 34fg
- 7895/45 36fg

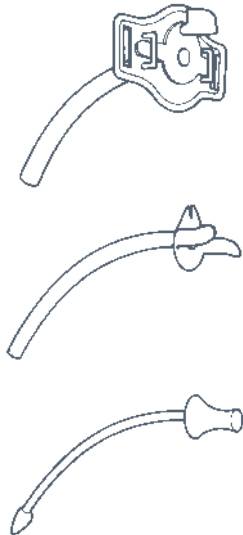

## Negus

Solid silver, inner tube with valve,  
plain inner tube with pilot

- 7901/05 16fg
- 7901/10 18fg
- 7901/15 20fg
- 7901/20 22fg
- 7901/25 24fg
- 7901/30 26fg
- 7901/35 28fg
- 7901/40 30fg
- 7901/45 32fg
- 7901/50 34fg
- 7901/55 36fg
- 7901/60 38fg
- 7901/65 40fg

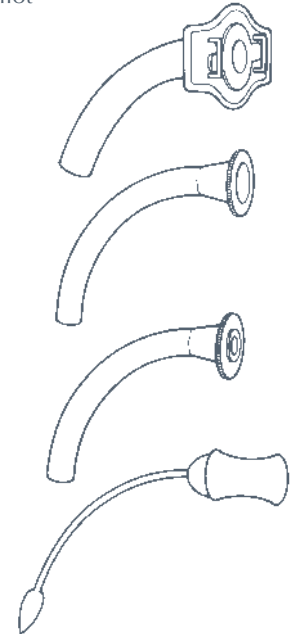

## TROCARS

## Tilley Harpoon

- 7910/05 170mm

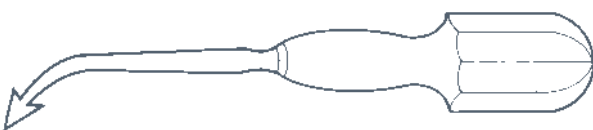

## Tilley Lichtwitz

cannula and tubing mount luer fitting, 195mm

- 7913/05 5fg
- 7913/10 6fg
- 7913/15 7fg
- 7913/20 8fg
- 7913/25 9fg

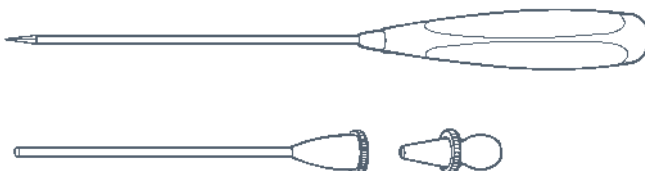



# TUNING FORKS

## Alloy

with foot

7920/05 C<sup>0</sup>, 128dv

7920/10 C<sup>1</sup>, 256dv

7920/15 C<sup>2</sup>, 512dv

7920/20 C<sup>3</sup>, 1024dv

7920/25 C<sup>4</sup>, 2048dv

7920/30 C<sup>5</sup>, 4096dv

7920/95 set of 6, complete in case

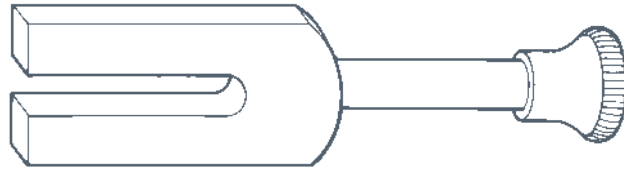

## Gardiner Brown

light pattern

7922/05 C<sup>0</sup>, 128dv

7922/10 C<sup>1</sup>, 256dv

7922/15 C<sup>2</sup>, 512dv

7922/20 C<sup>3</sup>, 1024dv

7922/25 C<sup>4</sup>, 2048dv

7922/30 C<sup>5</sup>, 4096dv

7922/95 set of 6, complete in case



## Hartmann

with foot

7926/05 C<sup>0</sup>, 128dv

7926/10 C<sup>1</sup>, 256dv

7926/15 C<sup>2</sup>, 512dv

7926/20 C<sup>3</sup>, 1024dv

7926/25 C<sup>4</sup>, 2048dv

7926/30 C<sup>5</sup>, 4096dv

7926/95 set of 6, complete in case



# TURBINATE FORCEPS

## Grunwald

narrow punch jaws,  
105mm effective length

7935/05 pattern A

7935/10 pattern B

7935/15 pattern C

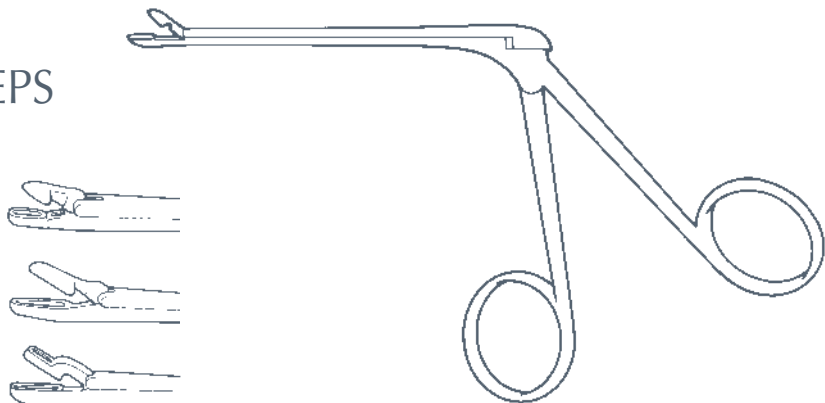

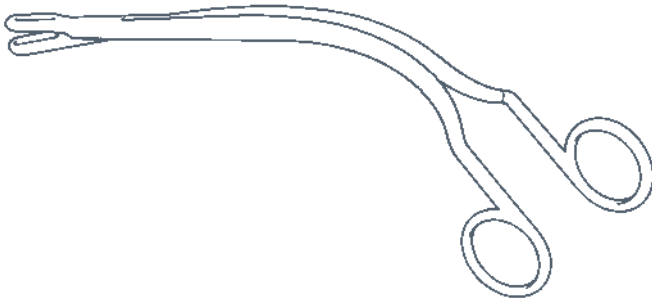

## TURBINATE FORCEPS

**Irwin Moore**

190mm  
7938/05

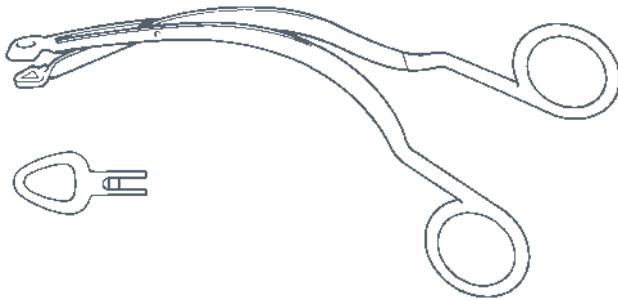
**Luc**

heart-shaped, 175mm  
7941/05 small  
7941/10 medium  
7941/15 large

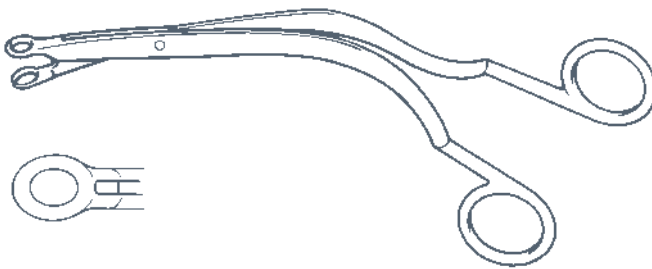
**Luc**

oval, 190mm  
7942/05 small  
7942/10 medium  
7942/15 large

## WOOL CARRIERS

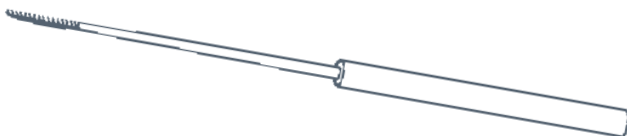
**Heath**

fine 170mm  
7955/05

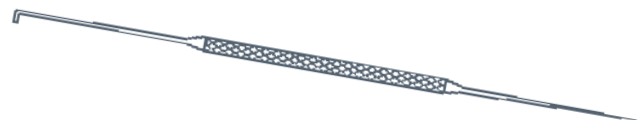
**Musgrove**

175mm  
7958/05







## BONE AWLS

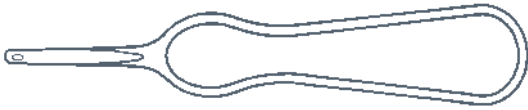

### Kelsey Fry

straight  
8005/05 145mm



### Kelsey Fry

curved  
8006/05 175mm

## BONE CUTTING FORCEPS

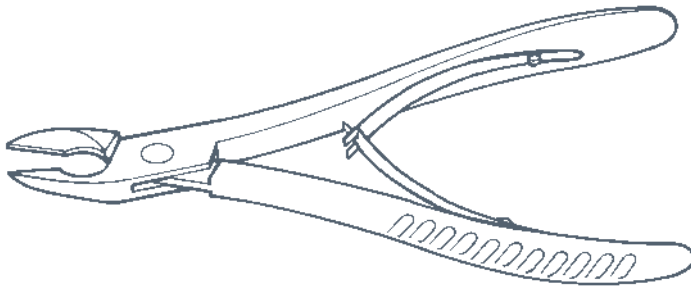

### Ward

slight angle  
8010/05 170mm

## CHISELS

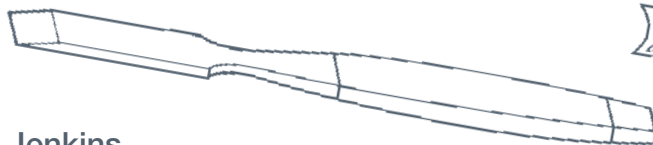

### Jenkins

length 145mm  
8025/05 2mm  
8025/10 4mm  
8025/15 6mm  
8025/20 8mm  
8025/25 10mm  
8025/30 12mm  
8025/35 14mm



### McIndoe

length 150mm  
8030/05 9mm  
8030/10 10mm  
8030/15 11mm  
8030/20 15mm



# CHISELS

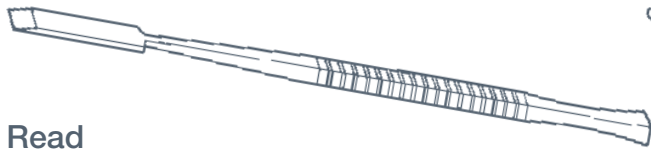

### Read

- length 180mm
- 8035/05 2mm
- 8035/10 3mm
- 8035/15 4mm
- 8035/20 5mm

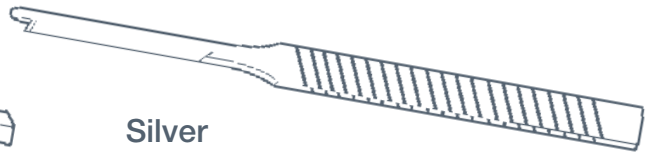

### Silver

- straight
- 8045/05 length 180mm

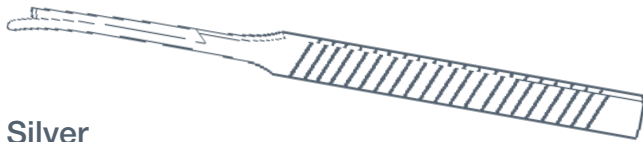

### Silver

- curved to left
- 8046/05 length 180mm

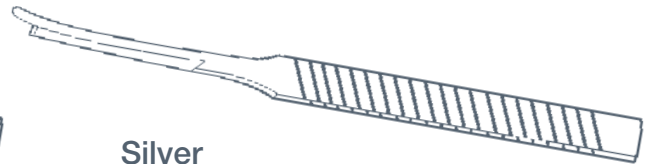

### Silver

- curved to right
- 8047/05 length 180mm

### Ward

- length 180mm
- 8055/05 3mm
- 8055/10 5mm

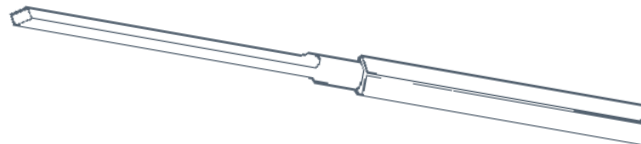

# COLLAR CRUSHING FORCEPS

### Denis Browne

- 8060/05 145mm

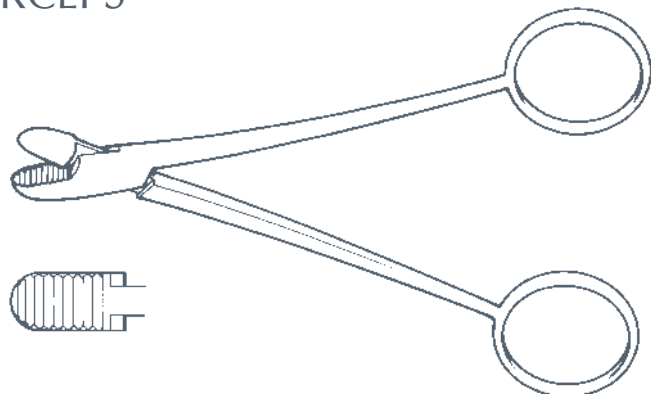



## CURETTES



### Exner

double ended, oval/round end  
8065/25 175mm



### Exner

double ended, angled oval ends  
8065/50 175mm



### Exner

double ended, angled round ends  
8065/75 175mm



### MacEwen

double ended  
8067/25 180mm oval  
8067/50 180mm round

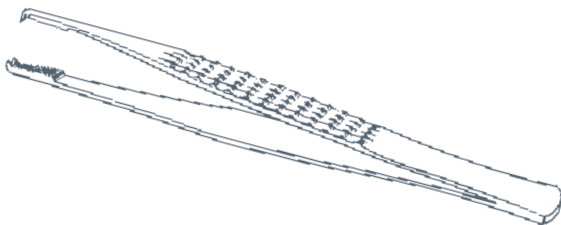

### Lanes

Rough handle, 1/2 teeth, serrated jaws  
8069/05 140mm  
8069/10 180mm

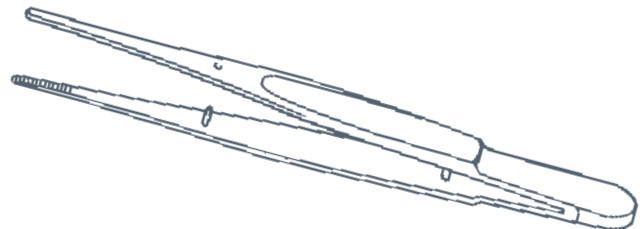

### Mount Vernon

serrated  
8070/05 100mm

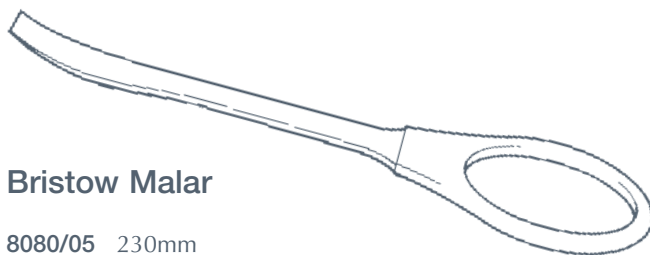

### Bristow Malar

8080/05 230mm

## ELEVATORS

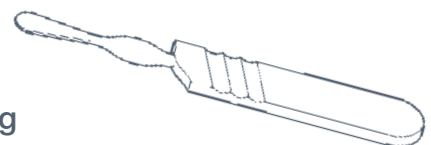

### Fickling

periosteal  
8085/05 130mm



# ELEVATORS

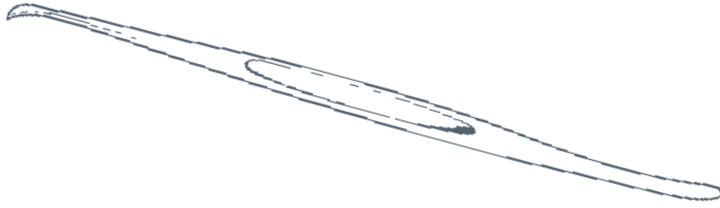

**Howarth**

double ended  
8090/05 220mm

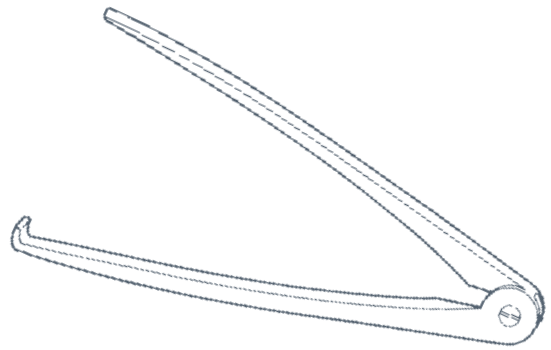

**Kilner Malar**

8095/05 180mm

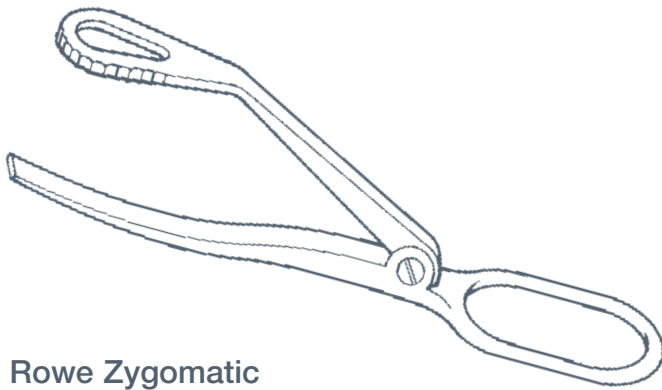

**Rowe Zygomatic**

8100/05 215mm

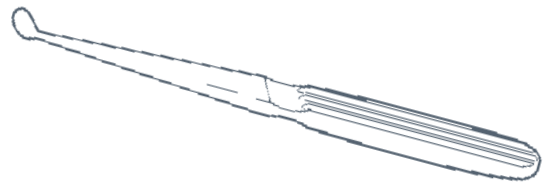

**Ward**

periosteal, fan shape  
8110/05 170mm

# FILES

**Alveolectomy**

double ended  
8115/05 170mm





## GOUGES

## Read



length 180mm

8125/05 2mm

8125/10 3mm

8125/15 4mm

8125/20 5mm

## MALLETS

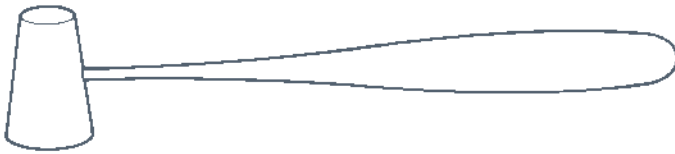

## Fickling Dental

190mm x 25mm head

8135/05 6<sup>3</sup>/<sub>4</sub>oz

## Toffee Hammer

8140/05 340grms

## MAPPING PENS



## Eckhoff

complete

8145/05 145mm

8145/50 spare nib for above



## Sommerlad

complete with adjustable tip

8150/05 150mm





## MAXILLA INSTRUMENTS

### Awl

alveolar-pernasal wiring  
8155/05 225mm



### Awl

mandibular  
8156/05 140mm



### Awl

zygomatic suspension  
8157/05 180mm



### Chisel

Pterigoideus  
8158/05 235mm



### Osteotome

length 160mm  
8160/05 2.5mm  
8160/10 4mm



### Raspatory

curved  
8161/05 205mm x 5mm  
8161/10 205mm x 8mm  
8161/15 205mm x 9mm





## MAXILLA INSTRUMENTS

**Raspatory**

curved, double ended

8162/05 205mm

**Retractor**

Awty osteotomy, 2 required

8163/05 215mm x 12mm

8163/10 215mm x 17mm

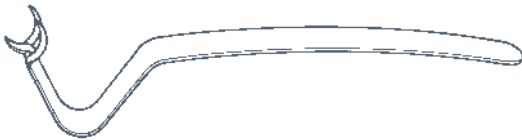
**Retractor**

chin, holding

8164/05 155mm

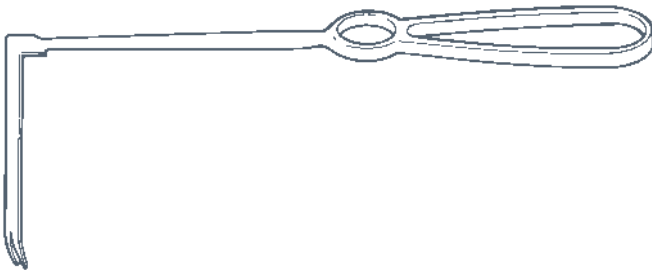
**Retractor**

forked

8165/05 220mm, 12mm x 70mm blade

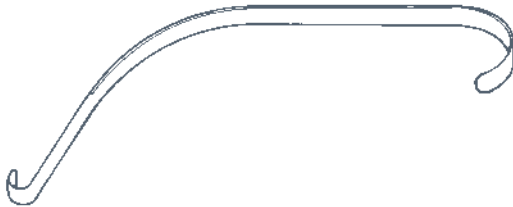
**Retractor**

prognathism channel, 2 required

8166/05 160mm

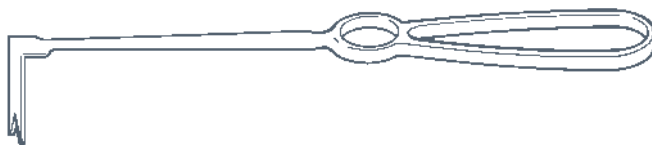
**Retractor**

Spina Nasalis

8167/05 220mm, 9.5mm x 44mm blade

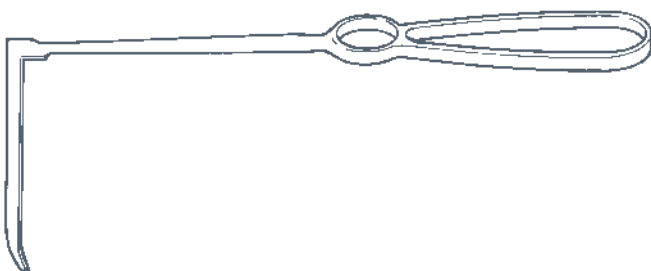
**Retractor**

stripping

8168/05 220mm, 14mm x 70mm blade



# MOUTH PROPS

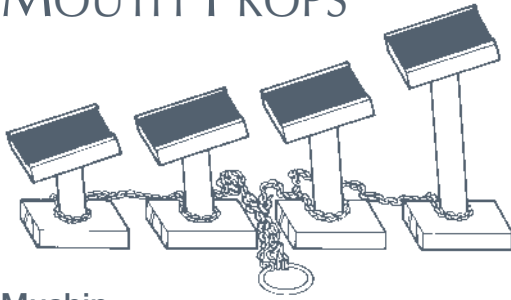

## Mushin

8175/05 set of 4 complete on chain

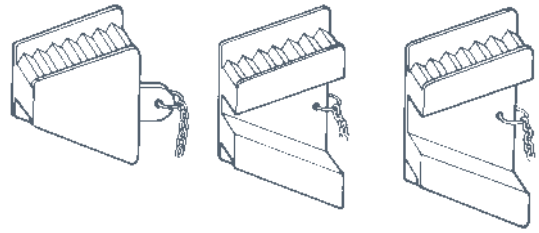

## Rubber

8180/05 small

8180/10 medium

8180/15 large

8180/95 set of 3 complete on chain

# NASAL SAWS

## Joseph

vertical shaft, 185mm

8185/25 cranked to the left

8185/50 cranked to the right

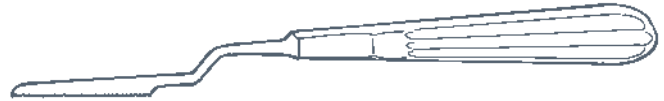

# NEEDLEHOLDERS

## Foster Miniature

left hand

8193/25 125mm

right hand

8193/50 125mm

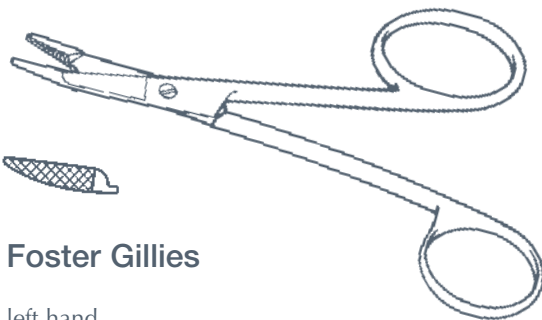
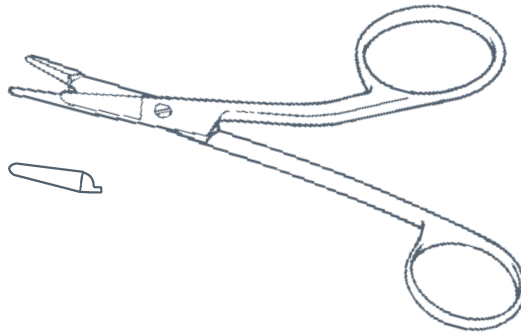

## Foster Gillies

left hand

8195/25 130mm

right hand

8195/50 130mm

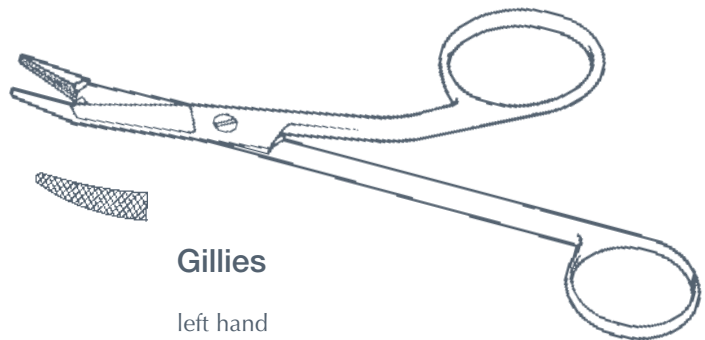

## Gillies

left hand

8200/25 165mm

right hand

8200/50 165mm





NEEDLEHOLDERS,  
TUNGSTEN CARBIDE

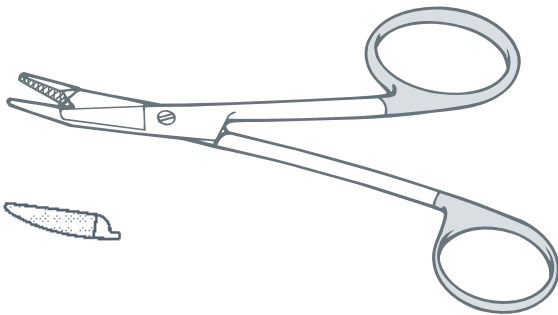

**Foster Gillies**

left hand  
8205/25 130mm  
  
right hand  
8205/50 130mm

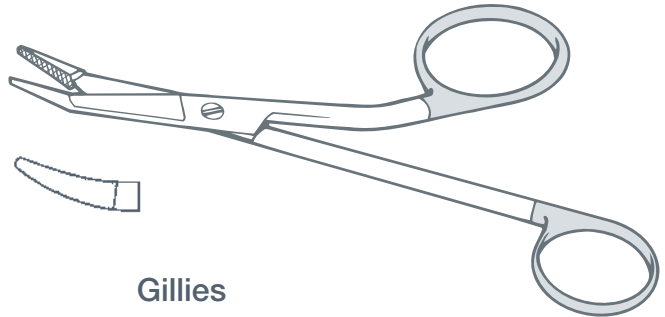

**Gillies**

left hand  
8210/25 165mm  
  
right hand  
8210/50 165mm

ORAL FORCEPS

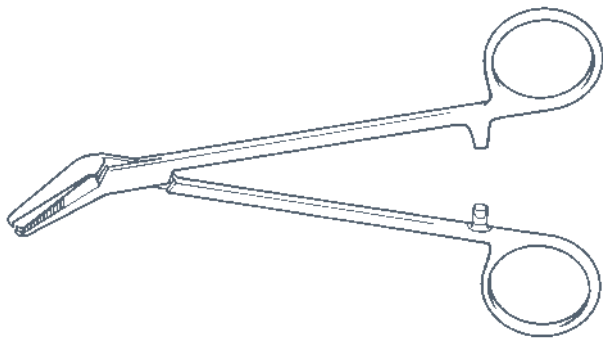

**Fickling**

serrated  
8215/05 180mm  
  
1/2 teeth  
8216/05 180mm

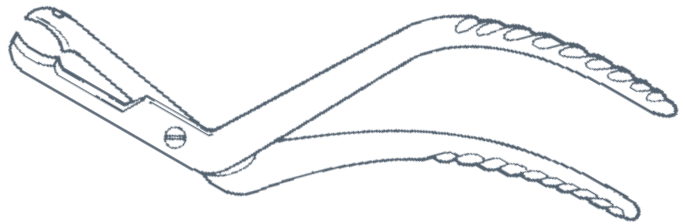

**Harrison Mandible**

screw joint  
8220/05 215mm

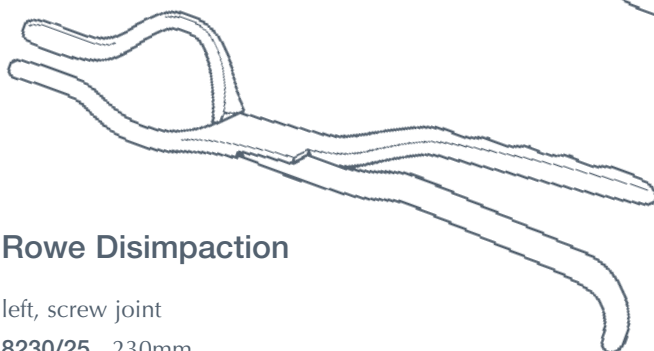

**Rowe Disimpaction**

left, screw joint  
8230/25 230mm

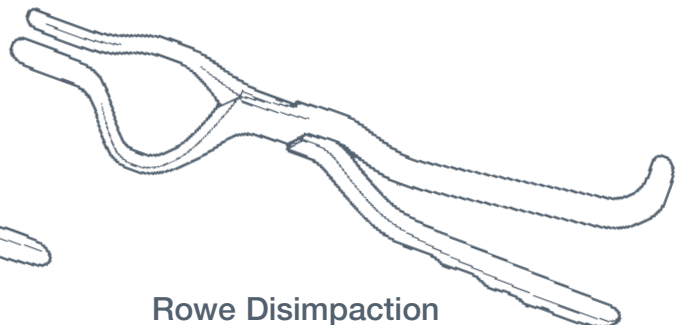

**Rowe Disimpaction**

right, screw joint  
8230/50 230mm



# OSTEOTOMES

## Gillies (French)

length 140mm

8240/05 5mm

8240/10 7mm

8240/15 9mm

8240/20 11mm



## Read

length 180mm

8245/05 4mm

8245/10 5mm



## Ward

length 180mm

8250/05 3mm

8250/10 5mm



# RASPATORIES

## Barsky

8270/05 double ended



## Cleft Palate

8275/25 curved downwards

8275/50 curved upwards



## Cleft Palate

curved upwards

8276/25 left

8276/50 right



## McIndoe

8278/05 small

8278/10 medium

8278/15 large





## RASPS

**Joseph Nasal**

file end, fine  
8280/05 165mm

**Joseph Nasal**

file end, coarse  
8281/05 165mm

**Joseph Nasal**

fine teeth 1mm  
8282/05 165mm

**Joseph Nasal**

coarse teeth 1.5mm  
8283/05 165mm

**Maltz**

curved  
8290/05 165mm

**Maltz**

straight  
8291/05 180mm



## RETRACTORS

### Bowdler-Henry Rake

8305/05 190mm

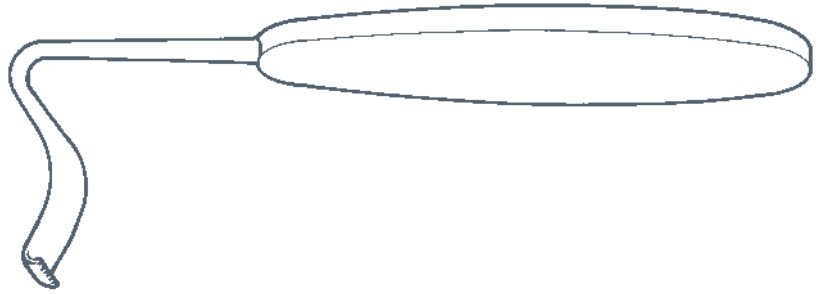

### Desmarres

140mm

8310/05 12mm wide

8310/10 14mm wide

8310/15 16mm wide



### Hajek

upper lip

8315/05 165mm

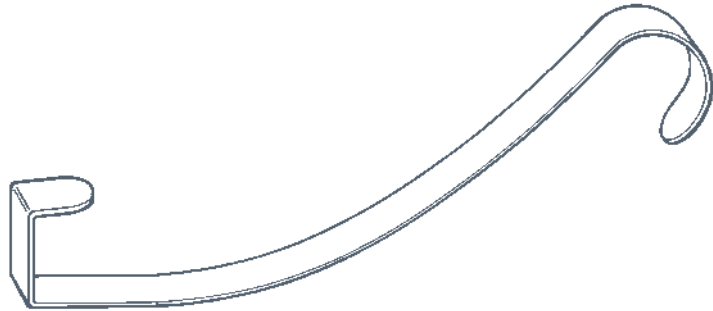

### Kay Austin

8320/05 140mm

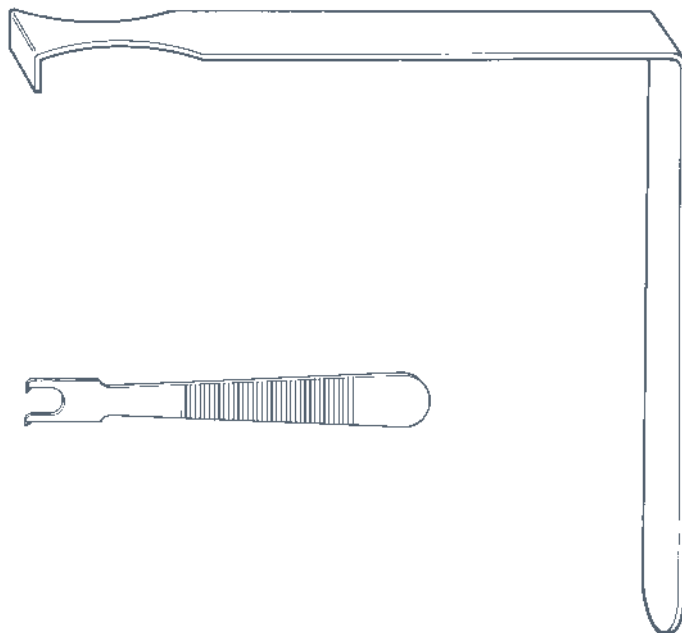

### Kilner Alae

8325/05 85mm x 10mm

8325/10 85mm x 13mm



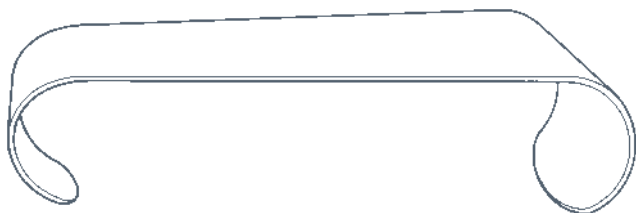

## RETRACTORS

**Kilner Cheek**

double ended

8330/05 25mm x 19mm

8330/10 35mm x 30mm

**Kilner Double Ended**

8333/05 150mm

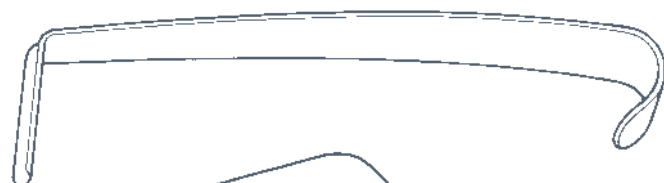
**Kilner Nasal**

8335/05 150mm

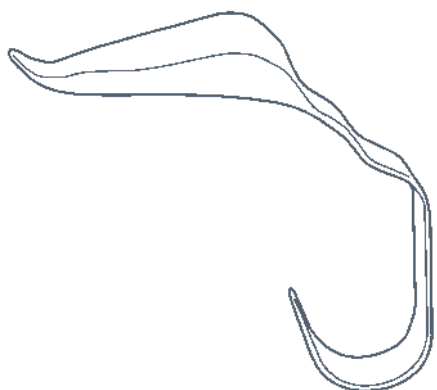
**Laster Cheek**

8340/05 100mm

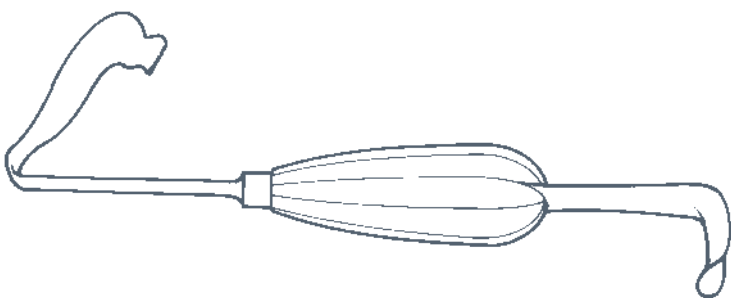
**Rowe Buccal**

double ended, curved to left

8345/25 215mm

double ended, curved to right

8345/50 215mm

**Rowe Lingual**

double ended, curved to left

8350/25 250mm

double ended, curved to right

8350/50 250mm



## RETRACTORS

### Ward Cheek

double ended  
8355/05 150mm

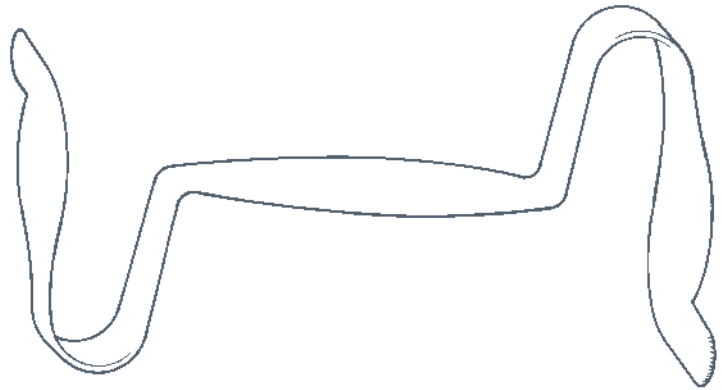

## RETRACTORS, SELF-RETAINING

### Alms

8357/05 70mm  
8357/10 100mm

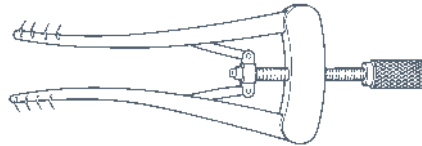

## SCALPELS

### Barron Handle

for use with No. 10, 11, 12 and 15 blades  
8360/05 130mm



## SCISSORS

### Alar Cartilage

curved  
8363/05 110mm

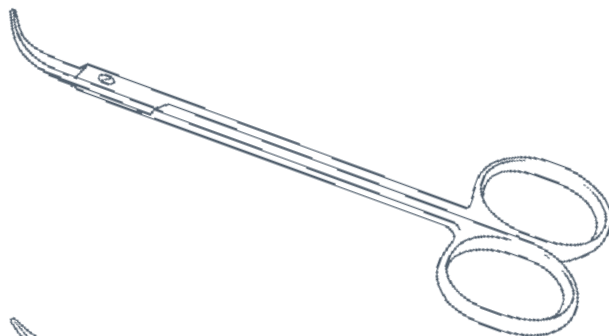

### Campbell Suture

curved, needle points  
8365/05 100mm

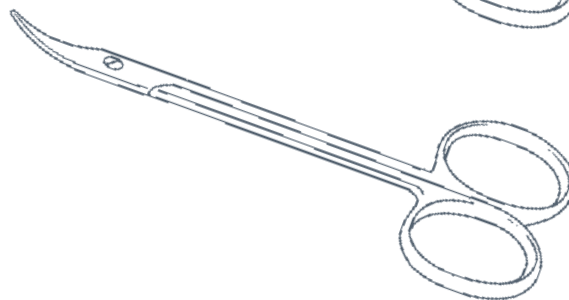

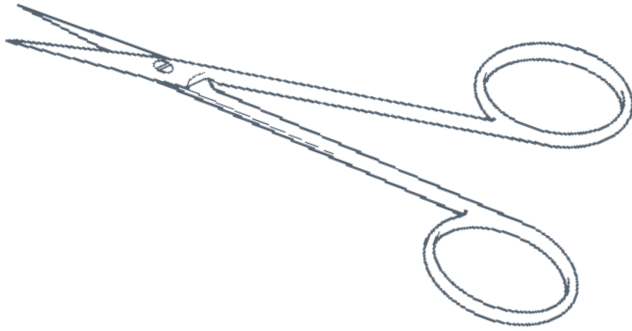

## SCISSORS

**Kilner**

straight, sharp points, rounded blades

8370/05 110mm

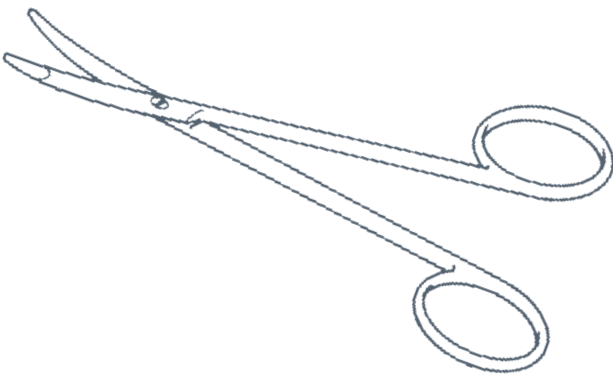
**Kilner**

curved, blunt points

8371/05 110mm

## SEPTUM FORCEPS

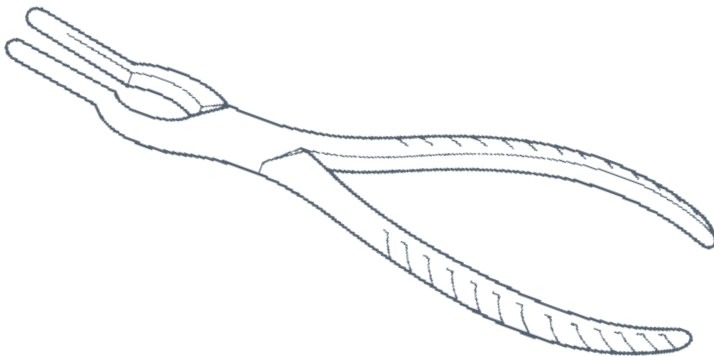
**Asch**

8380/05 235mm

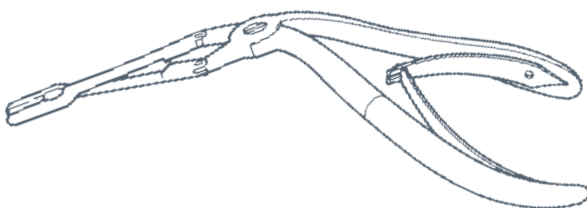
**Jansen-Middleton**

double action

8385/05 185mm



## SEPTUM FORCEPS

### Walsham

redressing, left  
8390/25 220mm



### Walsham

redressing, right  
8390/50 220mm



### Walsham

straight  
8390/75 190mm



## SKIN GRAFT BOARDS

### Wood

bevelled edge  
8395/05 180mm x 90mm

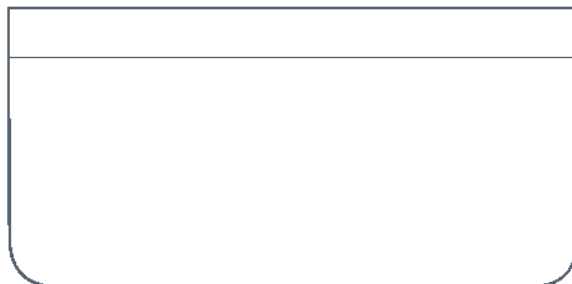



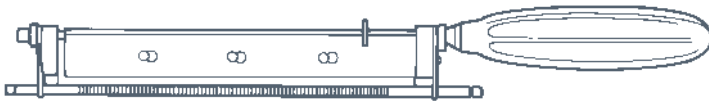

## SKIN GRAFT KNIVES

**Braithwaite**

complete with 10 blades  
8400/05 305mm

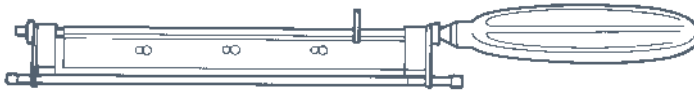
**Cobbett**

complete with 10 blades  
8405/05 305mm  
8406/05 spare blades for Braithwaite,  
Cobbett and Watson knives

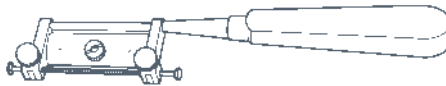
**Silver**

complete with blade, 190mm  
8410/25 right hand  
8410/50 left hand  
8410/90 spare blade

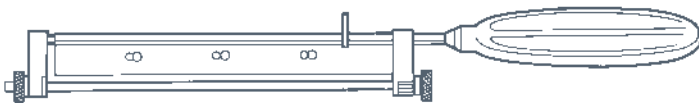
**Watson**

complete with 10 blades  
8412/05 305mm

## SKIN HOOKS

**Gillies**

185mm  
8420/05 small  
8420/10 large

**Kilner**

8425/05 140mm

**McIndoe**

8430/05 190mm

**McIndoe Double**

length 150mm  
8435/05 9mm  
8435/10 10mm  
8435/15 11mm



### SUTURE FORCEPS

#### Mustarde

8437/05 125mm

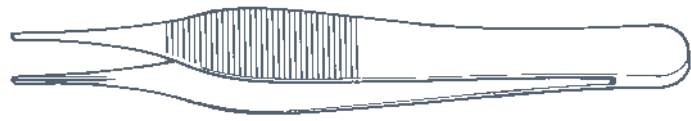

### WIRE CUTTERS

#### Tungsten Carbide Jaws

to cut 0.5mm hard wire, or 0.7mm soft

8450/05 140mm

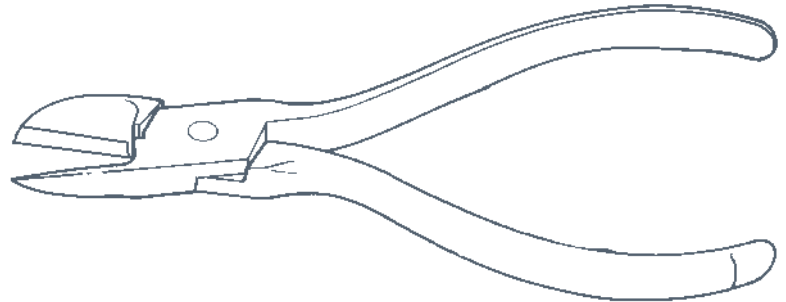

### WIRE FORCEPS

#### Hayton Williams

8455/05 112mm

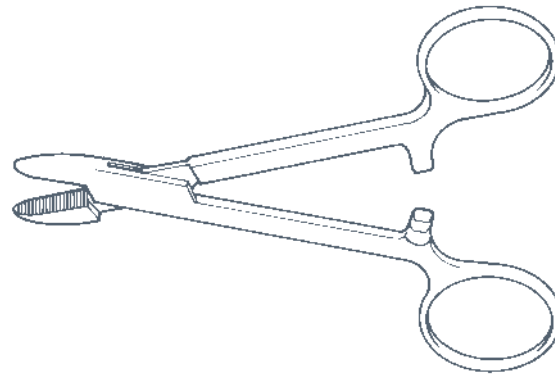

#### Lawson Tait

Pattern A

8457/25 140mm



Pattern B

8457/50 140mm

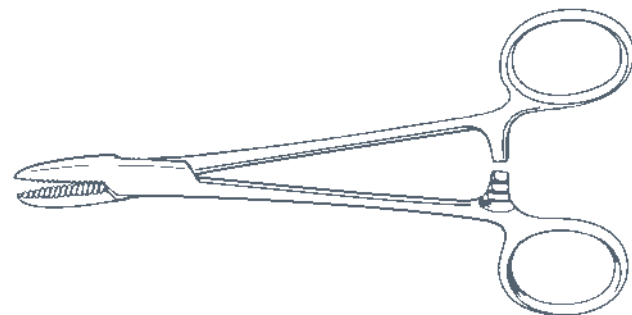



# A

<b>Abel</b>	
Scissors	96
<b>Abrams</b>	
Biopsy Punch	63
<b>Adams</b>	
Pliers	130
Tenotomy Knives	166
<b>Adson</b>	
Diathermy Forceps	13
Dissecting Forceps	15
Dissecting Forceps, (Bayonet)	142
Dural Hooks	144
Elevators (Periosteal)	145
Retractors, Self-Retaining	36
<b>Adson (Fraser)</b>	
Artery Forceps	1
Suction Tubes	155
<b>Agnew</b>	
Myringotomes	199
<b>Alar</b>	
Scissors	232
<b>Albee</b>	
Osteotomes	169
<b>Allis</b>	
Tissue Forceps	58
<b>Allison</b>	
Lung Retractors	67
<b>Alms</b>	
Retractors, Self-Retaining	232
<b>Alveolectomy Files</b>	222
<b>Amalgam</b>	
Carrier	115
Instruments	115
<b>American</b>	
Spinal Curettes	142
Suction Tubes	57
<b>Amputation Saws</b>	38
<b>Anchoring Forceps</b>	
Robin	1
<b>Aneriod Sphygmomanometer</b>	55
<b>Aneurysm Needles</b>	29
<b>Angell James</b>	
Palate Lever	204
Punch Forceps	205
<b>Apical</b>	
Elevators	99,100
Exolevers	102
<b>Apical Clinic</b>	
Exolevers	102
<b>Artery Forceps</b>	
Adson (Fraser)	1
Birkett	179
Bland Sutton	1

<b>Artery Forceps (cont)</b>	
Cairns	139
Crile	139
Cushing	140
Dunhill	1
Fraser Kelly	2
Grey Turner	2
Harrison Cripps	2
Heiss	2
Jolls Thyroid	2
Kelly-Crile	3
Kilner	3
Kocher	3
Mayo	3
Mayo Oschner	3
Miles Phillips	4
Mixer	4
Mixer Baby	4
Mosquito, Halstead	4
Mosquito, Micro	5
Moynihan	5
Negus	179
Oschner	5
O'Shaughnessy	5
Roberts	63
Rochester-Pean	6
Ronald Edwards	6
Sawtell	179
Schmidt	179
Spencer-Wells	6
Wilson	179
<b>Arthur</b>	
Splinter Forceps	55
<b>Asch</b>	
Septum Forceps	233
<b>Aspirating Syringe</b>	133
<b>Aufricht</b>	
Retractors	207
Scissors	41
<b>Aural Dressing Forceps</b>	
Hartmann	183
Hunter Tod	183
Lucae	183
Tilley	183
Wilde	184
<b>Aural Forceps</b>	
Cawthorne	180
Fuller	180
Hartmann	180
Henckel	181
Hough	181
House-Dieter	181
McGee	182
Ormerod	182
Shea	182
Tabb Crura	183

<b>Aural Instruments</b>	
Crowthorne	184
Rosen	185
Schuknecht	186
Tray	186
<b>Aural Snare</b>	
Glegg	187
<b>Aural Specula</b>	
Rosen	187
Siegle (Peters)	187
Tumarkin	187
<b>Aural Syringe</b>	212
<b>Auvard</b>	
Vaginal Specula	84
<b>Awl</b>	
Bone	157
Maxilla Instruments	224

# B

<b>Babcock</b>	
Tissue Forceps	58
<b>Backhaus</b>	
Towel Clips	59
<b>Bacon</b>	
Syringe	212
<b>Bailey</b>	
Rib Spreaders	68
<b>Balfour</b>	
Retractors, Self-Retaining	36
<b>Ballenger</b>	
Nasal Knives	201
<b>Band Removing Pliers</b>	130
<b>Bandage</b>	
Esmarch	7
<b>Bankhart</b>	
Bone Levers	162
<b>Barany Noise Apparatus</b>	204
<b>Barnes</b>	
Obstetric Forceps	77
Scissors	80
<b>Barnhill</b>	
Curettes	191
<b>Barron</b>	
Haemorrhoid Ligator Set	93
Scalpels	232
Suction Tubes	210
<b>Barsky</b>	
Raspatories	228
<b>Bateman</b>	
Pituitary Forceps	205
<b>Baumgartner</b>	
Needleholders, TC	26
<b>Beaver Blade Holder</b>	135



<b>Beck</b>	
Rongeurs	150
<b>Beckmann</b>	
Curettes	191
<b>Bellucci</b>	
Suction Tubes	210
<b>Bennett</b>	
Bone Levers	162
<b>Berkeley-Bonney</b>	
Clamps	73
<b>Bickford</b>	
Dissecting Forceps	15
<b>Biopsy Forceps</b>	
Chevalier Jackson	188
Paterson	188
Yeomans	91
<b>Biopsy Punch</b>	
Abrams Pleural	63
Eppendorf	71
Leech Wilkinson	71
Schubert	71
Van Doren	71
Wittner	71
<b>Bipod</b>	
Draffin	189
Magauran Plate	189
<b>Birkett</b>	
Artery Forceps	179
<b>Blacks</b>	
Files	135
Dental Instruments	117,118
<b>Blake</b>	
Retractors, Amputation	36
Knives	128
<b>Bland Sutton</b>	
Artery Forceps	1
<b>Blount</b>	
Staple Instruments	176
<b>Bohler</b>	
Bender	30
Stirrups	176
<b>Bone Awls</b>	
Kelsey Fry	219
With eye	157
<b>Bone Curettes</b>	
Charnley	157
Stanley Boyd	157
Volkman	157
<b>Bone Cutting Forceps</b>	
Horsley	158
Liston	158
Liston-Key	159
McIndoe	159
Paton	159
Stamm	159
Ward	219

<b>Bone Holding Clamps</b>	
Lowman	159
<b>Bone Holding Forceps</b>	
Burns	160
Fergusson	160
Hey Groves	160
Lane	160
Necrosis (Sequestrum)	160,161
St Thomas	161
Verbrugge	161
<b>Bone Hooks</b>	
Langenbeck	161
Kocher	161
<b>Bone Levers</b>	
Bankhart	162
Bennett	162
Chamley	162
Fagge	162
Lane	162
Murphy Skid	162
Trethowan	162
<b>Bone Rasp/File</b>	164
<b>Bonney</b>	
Clamps	73
Dissecting Forceps	16
Uterine Forceps	83
<b>Bougies</b>	
Clutton	87
<b>Bowdler-Henry</b>	
Retractors	230
<b>Bowel Scissors</b>	41
<b>Bozemann</b>	
Dressing Forceps	76
Needleholders	23
<b>Brace</b>	
Hudson	140
<b>Brain Knives</b>	22
<b>Braithwaite</b>	
Dissecting Forceps	16
Skin Graft Knives	235
<b>Braun-Stadler</b>	
Scissors	80
<b>Bristow</b>	
Elevators	164,221
<b>Brodie</b>	
Probes	32
<b>Bruns/Bohler</b>	
Shears	30
<b>Brush, Wire</b>	7
<b>Bryant</b>	
Dressing Forceps	20
<b>Burnishers, Dental</b>	115
<b>Burns</b>	
Bone Holding Forceps	160
<b>Burs</b>	
Hudson	141
Paton	163
Tilley	189

<b>C</b>	
<b>Cable Diathermy</b>	11
<b>Cairns</b>	
Artery Forceps	139
Dissecting Forceps	143
Dressing Forceps	144
Dural Hooks	144
Retractors (strip)	146
Scissors	155
<b>Campbell</b>	
Scissors	232
<b>Canadian</b>	
Dissecting Forceps	16,17
<b>Cannula</b>	
Cone Ventricular	141
Jefferson Ventricular	141
Leech Wilkinson	72
Spackman Intra Uterine	72
<b>Canny Ryall</b>	
Retractors	33
<b>Capener</b>	
Chisels	163
Gouges	145
Osteotomes	169,170
<b>Capsulotomy</b>	
Scissors	175
<b>Carless</b>	
Scissors	42
<b>Carriers</b>	
Diathermy	12
<b>Cartilage</b>	
Knives	22
Scissors	41
<b>Cartridge Syringe</b>	133
<b>Carvers, Dental</b>	116,117
<b>Catheter Introducers</b>	
Foley Balloon	87
Guyen	87
<b>Catheters</b>	
Female	72
Rotunda	72
Woakes Eustachian	189
<b>Catlin</b>	
Knives	22
<b>Cawthorne</b>	
Aural Forceps	180
Aural Instruments	184
Cerumen Hooks	190
Nasal Forceps	199
Scissors	208
<b>Cerumen Hooks</b>	
Cawthorne	190
Formby	190
Lucae	190
St Barts	190



<b>Charnley</b>		<b>Clamps (cont)</b>		<b>Cooper</b>	
Bone Curettes	157	Gwilliam	73	Needles	29
Bone Lever	162	Heaney	74	<b>Coupland</b>	
Retractors	172	Kocher Intestinal	8	Chisels	99
Retractors, Initial Incision	172	Lanes Intestinal	8	<b>Crafoord</b>	
Retractors, Laminectomy	146	Lanes Twin	9	Clamps	63
Suture Forceps	177	Lang Stevenson	9	<b>Crile</b>	
<b>Chassar Moir</b>		Lloyd-Davies	91	Artery Forceps	139
Scissors	80	Maingot	74	<b>Crile Murray</b>	
<b>Cheatles</b>		Parker Kerr	9	Needleholders	23
Steriliser Forceps	56	Payr	10	<b>Crile Wood</b>	
<b>Chevalier Jackson</b>		Schoemaker-Ogilvie	10	Needleholders	23
Biopsy Forceps	188	Semb	63	Needleholders, TC	26
Laryngeal Forceps	195	Thomson-Walker Pedicle	88	<b>Crown &amp; Collar Scissors</b>	131
Nodule Forceps	203	Thomson-Walker Penile	88	<b>Cryer</b>	
Tracheostomy Tubes	215	<b>Clamps, Atraumatic</b>		Exolevers	103
<b>Chip Syringe</b>	133	DeBakey	64,65	<b>Curettes</b>	
<b>Chiropody Instruments</b>		Doyen	10	American Spinal	142
Blacks Files	135	Einsell Foss	91	Barnhill	191
Probes	135	Hayes	92	Beckmann	191
Beaver Holder	135	Herrick	88	Charnley	157
Chisel	135	Hysterectomy	74	Exner	22
<b>Chiropody Knives</b>		Satinsky	65,66	House	191
Scalpels	136	<b>Cleft Palate Raspatories</b>	228	MacEwen	221
<b>Chiropody Nippers</b>		<b>Clip Forceps</b>		Mackie	191
Concave	136	Comyns Berkeley	11	St Clair Thompson	191
Flat	136	McKenzie	142	Sharman	75
Thwaites	137	Michel	11	Sims	75
<b>Chiropody Scissors</b>	137	Raney	142	Stanley Boyd	157
<b>Chisels</b>		<b>Clutton</b>		Volkman	157
Capener	163	Bougies	87	<b>Currie</b>	
Chiropody	135	<b>Cobb</b>		Uterine Scissors	81
Coupland	99	Elevator	145	<b>Cusco</b>	
Jenkins	219	Periosteal Elevator	164	Vaginal Specula	84
McIndoe	219	<b>Cobbett</b>		<b>Cushing</b>	
Maxilla	224	Skin Graft Knives	235	Artery Forceps	140
Post Mortem	31	<b>Coleman</b>		Retractors	147
Read	220	Elevators	100	Rongeurs	150
Silver	220	<b>Collar Crushing Forceps</b>		<b>Cut-Out Adaptor</b>	211
Smith Petersen	163	Denis Browne	220	<b>Czerny</b>	
Swedish	163	<b>College Dressing</b>		Retractors	33
Ward	220	Tweezers	132		
<b>Cholecystectomy Forceps</b>		<b>Collin</b>			
Geary Grant	7	Tongue Forceps	213		
Lahey	7	<b>Collingwood Stewart</b>			
Moynihah	7	Hernia Forceps	21		
<b>Citelli</b>		<b>Comyns Berkeley</b>			
Punch Forceps	206	Clip Forceps	11	<b>Dandy</b>	
<b>Clamps</b>		<b>Conchotomes</b>		Retractors	147
Berkeley-Bonney	73	Hartmann	190	<b>Davis-Boyle</b>	
Bonney	73	<b>Condensers, Dental</b>	115	Mouth Gags	198
Crafoord	63	<b>Cone</b>		<b>Deaver</b>	
Doyen Intestinal	8	Cannula	141	Retractors	33
Faure	73	Retractors, Self-Retaining	148	<b>DeBakey</b>	
Fergusson Angiotribe	8	<b>Continental</b>		Clamps, Atraumatic	64,65
Finch	91	Dissecting Forceps	17	Needleholders, TC	26
Guard, Parker Kerr	9			Tissue Forceps	69

## D

<b>Dandy</b>	
Retractors	147
<b>Davis-Boyle</b>	
Mouth Gags	198
<b>Deaver</b>	
Retractors	33
<b>DeBakey</b>	
Clamps, Atraumatic	64,65
Needleholders, TC	26
Tissue Forceps	69



<b>De Martel Gigli Guide</b>	154	<b>Dissecting Forceps (cont)</b>		<b>Dunhill</b>	
<b>Denis Browne</b>		Gillies	17	Artery Forceps	1
Collar Crushing Forceps	220	Iris	18	<b>Dupuytren</b>	
Intestinal Forceps	21	Jackson Burrows	164	Needles	29
Tonsil Holding Forceps	214	Jeans	18	<b>Dural Hooks</b>	
<b>Dental Files</b>		Jefferson	143	Adson	144
Miller	128	Lanes	18,221	Cairns	144
<b>Derf</b>		Leedham Green	18	<b>Durham</b>	
Needleholders	23	McIndoe	18	Dissectors	20
Needleholders, TC	26	Maingot	19	Retractors	33
<b>Deschamps</b>		Millin	88	<b>Duval</b>	
Needles	29	Moorfield Fixation	19	Lung Forceps	66
<b>Desjardins</b>		Mount Vernon	221	Tissue Forceps	58
Gallstone Forceps	21	Nelson	66		
<b>Desmarres</b>		Officer	93		
Retractors	230	Pennybacker	143		
<b>Diathermy</b>		Ramsey	19		
Cable	11	St Marks Hospital	19		
Carriers	12	Treves	19		
Electrode	12	Turn-Over-End	19		
Electrode, Knife	12	Waugh	20		
Handles	12	<b>Dissectors</b>		<b>Eckhoff</b>	
Loops	12	Durham	20	Mapping Pens	223
Needles	12	Gwynne Evans	192	<b>Einsell Foss</b>	
Quiver	12	Hurd	192	Clamp, Atraumatic	91
<b>Diathermy Forceps</b>		Kocher, Thyroid	20	<b>Electrode</b>	
Adson	13	MacDonald	20	Diathermy	12
Dissecting	13	Mollison	192	Diathermy, Knife	12
Gillies	13	Negus, Aspirating	193	Diathermy, Simpson	192
McIndoe	13	Pennybacker	143	<b>Elevators</b>	
Remington-Hobbs	192	St Clair Thompson	193	Adson (periosteal)	145
Riches	14	Swedish	143	Apical	99,100
Waugh	14	Syme	193	Bristow	164,221
Wilson Hey	14	Watson Cheyne	20	Cobb	145
<b>Diathermy Scissors</b>		<b>Doyen</b>		Cobb, periosteal	164
Turner-Warwick	15	Clamps, Intestinal	8	Coleman	100
<b>Dilators</b>		Clamps, Atraumatic	10	Doyen, Periosteal	66
Hegar, Cervix	76	Elevators, Periosteal	66	Fickling	221
St Mark's	92	Mouth Gags	198	Freer	193
<b>Directors</b>		Myoma Screw	77	Hill	193
Lockhart Mummery Fistula	92	Retractors	33	Hospital	100
<b>Dissecting Scissors</b>	42	Scissors	42	Howarth	222
<b>Dissecting Forceps</b>		<b>Doyen (Pozzi)</b>		Kilner	222
Adson	15	Retractors	79	Lindo Levien	101
Adson Bayonet	142	<b>Draffin Bipod</b>	189	Pennybacker	145
Bickford	15	<b>Dressing Forceps</b>		Periosteal	99
Block End	16	Bozemann	76	Reads	101
Bonney	16	Bryant	20	Rowe Zygomatic	222
Braithwaite	16	Cairns	144	Spinal	164
Cairns	143	Cairns (Dott)	144	Tudor Edwards	66
Cairns (Dott)	143	French Bow	20	Ward	222
Canadian	16,17	Jefferson	144	Warwick James	101
Continental	17	<b>Dressing Scissors</b>		Winters Root	102
Diathermy	13	Plain	42,43	<b>Elliot Iris</b>	
Emmett	17	Hard Edge	50	Scissors	43
Fine	17	Ultra-Cutting	53	<b>Emmett</b>	
				Dissecting Forceps	17
				<b>Engels</b>	
				Saws	38

## E



<b>Enucleation</b>	
Scissors	44
<b>Eppendorf</b>	
Biopsy Punch	71
<b>Esmarch</b>	
Bandage	7
<b>Eve</b>	
Tonsil Snare	214
<b>Excavators, Dental</b>	118.119
<b>Exner</b>	
Curettes	221
<b>Exolevers</b>	
Apical	102
Apical Clinic	102
Cryer	103
<b>Extracting Forceps</b>	
Children's Patterns	113,114
Lower Centrals and Roots	109
Lower Anteriors	109
Lower Molars	110
Lower Molars and Roots	112
Lower Wisdoms and Molars	111
Upper Anteriors	103
Upper Molars	107,108
Upper Premolars and Roots	104
Upper Roots	105,106
Upper Wisdoms and Roots	108

## F

<b>Fagge</b>	
Bone Levers	162
<b>Falconer</b>	
Suction Tubes	155
<b>Farabeuf</b>	
Rugines	175
<b>Faure</b>	
Clamps	73
<b>Female</b>	
Catheters	72
<b>Fergusson</b>	
Angiotribe	8
Bone Holding Forceps	160
Mouth Gags	23
Scissors	44
<b>Ferris-Smith-Kerrison</b>	
Rongeurs	151
<b>Fickling</b>	
Elevators	221
Mallets	223
Oral Forceps	227
<b>Files</b>	
Alveolectomy	222
Blacks	135

<b>Files (cont)</b>	
Bone Rasp/File	164
Tubby	164
<b>Finch</b>	
Clamps	91
<b>Finochietto</b>	
Needleholders, TC	27
Rib Spreaders	68
<b>Flat Nose Pliers</b>	130
<b>Foerster</b>	
Sponge Holding Forceps	56
<b>Foley Balloon</b>	
Catheter Introducers	87
<b>Forceps Jar</b>	61
<b>Formby</b>	
Cerumen Hooks	190
Suction Tubes	210
<b>Foster Gillies</b>	
Needleholders	226
Needleholders, TC	227
<b>Foster Miniature</b>	
Needleholders	226
<b>Fraser Kelly</b>	
Artery Forceps	2
<b>Freer</b>	
Elevators	193
Nasal Instruments	200
<b>French Bow</b>	
Dressing Forceps	20
<b>Frenchay</b>	
Towel Clips	59
<b>Fuller</b>	
Aural Forceps	180
<b>Furnace Tweezers</b>	132

## G

<b>Gabriel</b>	
Rectal Specula	94
<b>Galabin</b>	
Sounds	83
<b>Gallipots</b>	61
<b>Gallstone Forceps</b>	
Desjardins	21
<b>Gardiner Brown</b>	
Tuning Forks	216
<b>Geary Grant</b>	
Cholecystectomy Forceps	7
<b>Gelpi Vulva</b>	
Retractors, Self-Retaining	79
<b>Giertz</b>	
Rib Shears	67
<b>Gigli</b>	
Saws	154

<b>Gillies</b>	
Diathermy Forceps	13
Dissecting Forceps	17
Needleholders	226
Needleholders, TC	227
Osteotomes	228
Skin Hooks	235
Suction Tubes	83
<b>Glasgow</b>	
Iris Scissors	44
Rongeurs	153
<b>Glegg</b>	
Aural Snare	187
Nasal Snare	201
<b>Goligher</b>	
Retractors, Self-Retaining	36
Scissors	96
<b>Goodwin</b>	
Peritoneum Forceps	78
<b>Gosset</b>	
Retractors, Self-Retaining	36
<b>Gouges</b>	
Capener	145
Guy's	194
Jenkins	194
Killian	194
Read	223
Smith-Petersen	165
Swedish	165
Tilley	194
Tufnol Handle	165
<b>Graves</b>	
Vaginal Specula	84
<b>Green Armytage</b>	
Peritoneum Forceps	78
<b>Grey Turner</b>	
Artery Forceps	2
<b>Grunwald</b>	
Turbinate Forceps	216
<b>Guides</b>	
Pudendal Nerve Block	76
<b>Gum Scissors</b>	131
<b>Guyon</b>	
Catheter Introducers	87
<b>Guy's</b>	
Gouges	194
Shears	30
Suture Forceps	57
Tenotomy Knives	167
Tongue Forceps	59
<b>Gwilliam</b>	
Clamps	73
<b>Gwynne Evans</b>	
Dissectors	192



H

**Haemorrhoid Forceps**  
 St George's 94

**Haemorrhoid Ligator Set**  
 Barron 93  
 McGivney 39

**Hajek**  
 Mallets 168  
 Punch Forceps 206  
 Retractors 230

**Halsey**  
 Needleholders 24  
 Needleholders, TC 27

**Hammer**  
 Post Mortem 31

**Hand Drills**  
 Pistol Grip 165  
 Ralk 166

**Hand Instruments, Dental**  
 Amalgam 115  
 Amalgam Carrier 115  
 Blacks 117,118  
 Burnishers 115  
 Carvers 116,117  
 Condensers 115  
 Excavators 118,119  
 Plastics 119-121  
 Pluggers 115  
 Probes 122-124  
 Scalers 125-127  
 Spatulas 127

**Hand Splint, Lead** 166

**Handle**  
 Diathermy 12  
 Wire Instruments 177

**Harrison**  
 Oral Forceps 227

**Harrison Cripps**  
 Artery Forceps 2

**Hartmann**  
 Aural Dressing Forceps 183  
 Aural Forceps 180  
 Conchotomes 190  
 Nasal Forceps 199  
 Tuning Forks 216

**Harvey-Jackson**  
 Retractors, Self-Retaining 148

**Hayes**  
 Clamps, Atraumatic 92

**Hayton Williams**  
 Wire Forceps 236

**Heaney**  
 Clamps 74

**Heaths**  
 Mallets 168

**Heaths (cont)**  
 Scissors 44  
 Wool Carriers 217

**Hegar**  
 Dilators, Cervix 76  
 Needleholders 24

**Heiss**  
 Artery Forceps 2

**Henckel**  
 Aural Forceps 181  
 Punch Forceps 206

**Henderson**  
 Retractors, Self-Retaining 149

**Hennig**  
 Spreader 30

**Hernia Forceps**  
 Collingwood Stewart 11

**Herrick**  
 Clamps, Atraumatic 88

**Hey Groves**  
 Bone Holding Forceps 160

**Hibbs**  
 Retractors 147

**Hill**  
 Elevators 193

**Hohmann-Muller Spike**  
 Retractors 172

**Holloware**  
 Forceps Jar 61  
 Gallipot 61  
 Instrument Lid 61  
 Instrument Tray 61  
 Jug, Graduated 61  
 Kidney Dish 61  
 Lotion Bowl 61

**Horrocks**  
 Sounds 83

**Horsley**  
 Bone Cutting Forceps 158

**Hospital**  
 Elevators 100

**Hough**  
 Aural Forceps 181

**House**  
 Curettes 191  
 Nasal Instruments 200  
 Suction Tubes 210

**House-Dieter**  
 Aural Forceps 181

**Howarth**  
 Elevators 222

**Howe**  
 Pliers 130

**Hudson**  
 Brace 140  
 Burs 141

**Hughes Stapes**  
 Nasal Instruments 200

**Hunter**  
 Splinter Forceps 55

**Hunter Tod**  
 Aural Dressing Forceps 183

**Hurd**  
 Dissectors 192

**Hysterectomy, Clamps**  
 Atraumatic 74

I

**Inflation Bellows** 97

**Instrument Pins**  
 Mayo 21

**Instrument Trays** 61

**Intestinal Forceps**  
 Denis Browne 21

**Introducing Forceps**  
 Magill 22

**Iris**  
 Dissecting Forceps 18  
 Scissors 45  
 Scissors, Hard Edge 51  
 Scissors, Ultra-Cutting 53

**Irwin Moore**  
 Laryngeal Forceps 195  
 Turbinate Forceps 217

J

**Jackson Burrows**  
 Dissecting Forceps 164  
 Retractors 173  
 Retractors, Self-Retaining 174

**Jansen**  
 Retractors, Self-Retaining 149  
 Rongeurs 153,174

**Jansen-Middleton**  
 Septum Forceps 233

**Jeans**  
 Dissecting Forceps 18

**Jefferson**  
 Cannula 141  
 Dissecting Forceps 143  
 Dressing Forceps 144  
 Retractors, Self-Retaining 149

**Jenkins**  
 Chisels 219  
 Gouges 194

**Jobson Horne Probes** 205





<b>Johnson</b>	
Pliers	130
<b>Jolls</b>	
Artery Forceps	2
Needles	29
Retractors, Self-Retaining	37
<b>Jones</b>	
Rugines	175
Tenotomy Knives	167
<b>Joseph</b>	
Nasal Rasps	229
Nasal Saws	226
<b>Judd-Allis</b>	
Tissue Forceps	58
<b>Jug, Graduated</b>	61

## K

<b>Kay Austin</b>	
Retractors	230
<b>Kelly</b>	
Proctoscopes	94
Rectal Specula	94
Retractors	33
<b>Kelly-Crile</b>	
Artery Forceps	3
<b>Kelsey Fry</b>	
Bone Awls	219
<b>Kerrison</b>	
Rongeurs	151
<b>Kidney Dish</b>	61
<b>Kielland</b>	
Obstetric Forceps	77
<b>Killian</b>	
Gouges	194
Nasal Specula	202
<b>Kilner</b>	
Artery Forceps	3
Elevators	222
Needleholders	24
Needleholders, TC	27
Retractors	230, 231
Scissors	233
Scissors, Ultra-Cutting	53
Skin Hooks	235
<b>Knight (Heymann)</b>	
Scissors	209
<b>Knives</b>	
Adams Tenotomy	166, 167
Blake	128
Brain	22
Cartilage	22
Catlin	22
Guy's Tenotomy	167

<b>Knives (cont)</b>	
Jones Tenotomy	167
Liston	22
Monro Menisectomy	167
Paget	22
Parker Tenotomy	167
Plaster	128
Post Mortem	32
Smillie Menisectomy	167
Tenotomy	168
Tubby Tenotomy	168
Wax	128
<b>Knot Tier and Pusher</b>	
Negus	195
<b>Kocher</b>	
Artery Forceps	3
Bone Hook	161
Clamps, Intestinal	8
Dissector, Thyroid	20

## L

<b>Lack</b>	
Tongue Depressors	213
<b>Lagrange</b>	
Scissors	44
<b>Lahey</b>	
Cholecystectomy Forceps	7
<b>Landon</b>	
Retractors	79
<b>Lane</b>	
Bone Holding Forceps	160
Bone Levers	162
Clamps, Intestinal	8
Clamps, Twin	9
Dissecting Forceps	18, 221
Plate Bender	171
Tissue Forceps	58
<b>Lang Stevenson</b>	
Clamps	9
<b>Langenbeck</b>	
Bone Hooks	161
Retractors	34
<b>Laryngeal Forceps</b>	
Chevalier Jackson	195
Irwin Moore	195
Micro	196
<b>Laryngeal Mirrors</b>	197
<b>Laster Cheek</b>	
Retractors	231
<b>Lawrance</b>	
Needleholders	24
Needleholders, TC	27
<b>Lawson Tait</b>	
Wire Forceps	236
<b>Lead Hand Splint</b>	166
<b>Leech Wilkinson</b>	
Biopsy Punch	71
Cannula	72
<b>Leedham Green</b>	
Dissecting Forceps	18
<b>Leksell</b>	
Rongeurs	174
<b>Lempert</b>	
Nibbling Forceps	203
Rongeurs	174
Rugines	208
Scoops	210
Suction Tubes	211
<b>Lewer</b>	
Vulsellum Forceps	85
<b>Ligature Cutters</b>	130
<b>Lindo Levien</b>	
Elevators	101
<b>Lister</b>	
Scissors	45
Sinus Forceps	55
<b>Liston</b>	
Bone Cutting Forceps	158
Knives	22
<b>Liston-Key</b>	
Bone Cutting Forceps	159
<b>Littauer</b>	
Scissors	46
<b>Littlewood</b>	
Tissue Forceps	58
<b>Lloyd-Davies</b>	
Clamps	91
Retractors	95
Scissors	96
Sigmoidoscopes	97
<b>Lockhart Mummery Fistula</b>	
Directors	92
<b>Loops</b>	
Diathermy	12
<b>Lotion Bowl</b>	61
<b>Loute Tightener</b>	177
<b>Love</b>	
Retractors	147
<b>Love-Grunwald</b>	
Rongeurs	152
<b>Lowman</b>	
Bone Holding Clamps	159
<b>Luc</b>	
Turbinate Forceps	217
<b>Lucae</b>	
Aural Dressing Forceps	183
Cerumen Hooks	190
Nasal Forceps	199
<b>Luer</b>	
Rongeurs	174
Vulsellum Forceps	85



Lung Forceps	
Duval	66
Mayo	66

## M

<b>McClintock</b>	
Ovum Forceps	78
<b>McGee</b>	
Aural Forceps	182
<b>McGivney</b>	
Haemorrhoid Ligator Set	93
<b>McGoey</b>	
Punches	171
<b>McIndoe</b>	
Bone Cutting Forceps	159
Chisels	219
Diathermy Forceps	13
Dissecting Forceps	18
Raspatories	228
Skin Hooks	235
<b>McKenzie</b>	
Clip Forceps	142
<b>McKissock</b>	
Scissors	155
<b>MacDonald</b>	
Dissectors	20
<b>MacEwen</b>	
Curettes	221
<b>MacPhail</b>	
Needleholders	24
<b>Mackie</b>	
Curettes	191
<b>Magauran Plate</b>	189
<b>Magill</b>	
Introducing Forceps	22
Suction Tubes	211
<b>Maingot</b>	
Clamps	74
Dissecting Forceps	19
<b>Mallets</b>	
Fickling	223
Hajek	168
Heath	168
Mead	169
Stainless Steel	169
Toffee Hammer	223
<b>Maltz</b>	
Rasps	229
<b>Mapping Pens</b>	
Eckhoff	223
Sommerlad	223
<b>Marthew</b>	
Pliers	129

<b>Martin</b>	
Splinter Forceps	55
<b>Mathieu</b>	
Needleholders	24
<b>Matrix Clamp</b>	
Sigveland	133
<b>Maxilla Instruments</b>	
Awls	224
Chisel	224
Osteotome	224
Raspatory	224,225
Retractor	225
<b>Mayo</b>	
Artery Forceps	3
Instrument Pins	21
Lung Forceps	66
Needleholders	25
Needleholders, TC	27
Scissors	46
Scissors, Hard Edge	51
Scissors, Ultra-Cutting	53
Tongue Forceps	59
<b>Mayo Adson</b>	
Retractors, Self-Retaining	149
<b>Mayo Oschner</b>	
Artery Forceps	3
<b>Mayo-Stille</b>	
Scissors, Hard Edge	51
Scissors, Ultra-Cutting	54
<b>Mead</b>	
Mallets	169
<b>Metzenbaum</b>	
Scissors	47
Scissors, Hard Edge	51,52
Scissors, Ultra-Cutting	54
<b>Michel</b>	
Clip Forceps	11
<b>Miles Phillips</b>	
Artery Forceps	4
<b>Miller</b>	
Files	128
<b>Millin</b>	
Bladder Retractors	89
Dissecting Forceps	88
<b>Mirrors</b>	
Dental	128,129
Laryngeal	197
St Clair Thompson	197
<b>Mixer</b>	
Artery Forceps	4
<b>Mixer Baby</b>	
Artery Forceps	4
<b>Mollison</b>	
Dissectors	192
<b>Monaghan</b>	
Scissors	81

<b>Monro Menisectomy</b>	
Knives	167
<b>Moorfield Fixation</b>	
Dissecting Forceps	19
<b>Morris</b>	
Retractors	34
<b>Mosquito, Halstead</b>	
Artery Forceps	4
<b>Mosquito, Micro</b>	
Artery Forceps	5
<b>Mount Vernon</b>	
Dissecting Forceps	221
<b>Mouth Gag</b>	
Davis-Boyle	198
Doyen	198
Fergusson	23
Tongue Plates	198
<b>Mouth Props</b>	
Mushin	226
Rubber	226
<b>Moynihan</b>	
Artery Forceps	5
Cholecystectomy Forceps	7
Retractors	34
<b>Murphy Skid</b>	
Bone Levers	162
<b>Musgrove</b>	
Wool Carriers	217
<b>Mushin</b>	
Mouth Props	226
<b>Mustarde</b>	
Suture Forceps	236
<b>Myles</b>	
Perforators	204
<b>Myoma Screw</b>	
Doyen	77
<b>Myringotomes</b>	
Agnew	199
Poltitzer	199
Trautmann	199

## N

<b>Nasal Forceps</b>	
Cawthorne	199
Hartmann	199
Lucae	199
Tilley	199
<b>Nasal Instruments</b>	
Freer	200
House	200
Hughes Stapes	200
<b>Nasal Knives</b>	
Ballenger	201







<b>Retractors, Amputation</b>					
Blake Flap	36				
<b>Retractors, Self-Retaining</b>					
Adson	36				
Alms	232				
Balfour	36				
Cone	148				
Gelpi Vulva	79				
Goligher	36				
Gosset	36				
Harvey-Jackson	148				
Henderson	149				
Jackson Burrows	174				
Jansen	149				
Jefferson	149				
Jolls	37				
Mayo Adson	149				
Mollison	208				
Norfolk and Norwich	37				
Park	95				
Park Anal	95				
Travers	37				
Weislander	37				
Weitlaner	37				
West	37				
<b>Rib Shears</b>					
Giertz	67				
Spring	67				
Tudor Edwards	67				
<b>Rib Spreaders</b>					
Bailey	68				
Finochietto	68				
Sellers	68				
Tuffier	68				
<b>Riches</b>					
Diathermy Forceps	14				
<b>Ring Cutter</b>	38				
<b>Roberts</b>					
Artery Forceps	63				
<b>Robin</b>					
Anchoring Forceps	1				
<b>Rochester-Pean</b>					
Artery Forceps	6				
<b>Ronald Edwards</b>					
Artery Forceps	6				
<b>Rongeurs</b>					
Beck	150				
Cushing	150				
Dental	114				
Ferris-Smith-Kerrison	151				
Glasgow	153				
Jansen	153,174				
Kerrison	151				
Leksell	174				
Lempert	174				
Love-Grunwald	152				
<b>Rongeurs (cont)</b>					
Luer	174				
Northfield	152,153				
Pennybacker	152,153				
Ruskin	154				
Trotter	154				
Van Havre (Sargent)	154				
<b>Rosen</b>					
Aural Instruments	185				
Aural Specula	187				
<b>Rotunda</b>					
Catheters	72				
<b>Rowe</b>					
Elevators, zygomatic	222				
Oral Forceps	227				
Retractors, Buccal	231				
Retractors, Lingual	231				
<b>Rugines</b>					
Farabeuf	175				
Jones	175				
Lempert	208				
<b>Ruskin</b>					
Rongeurs	154				
<b>Rutherford Morison</b>					
Tissue Forceps	59				
<b>Ryder</b>					
Needleholders, TC	28				
<b>S</b>					
<b>St Bartholomew's</b>					
Cerumen Hooks	190				
Punch Forceps	207				
<b>St Clair Thompson</b>					
Curettes	191				
Dissectors	193				
Mirrors, Rhinoscope	197				
Nasal Specula	202				
<b>St George's</b>					
Haemorrhoid Forceps	94				
<b>St Marks Hospital</b>					
Dilators	92				
Dissecting Forceps	19				
Retractors	34				
<b>St Thomas</b>					
Bone Holding Forceps	161				
Raspatories	171				
<b>Satinsky</b>					
Clamps, Atraumatic	65,66				
<b>Saws</b>					
Amputation	38				
De Martel Gigli Guide	154				
Engels	38				
Gigli	154				
<b>Sawtell</b>					
Artery Forceps	179				
<b>Scalers, dental</b>	125-127				
<b>Scalpels</b>					
Barron	232				
Chiropody	136				
Swann Morton	39,40				
<b>Schmidt</b>					
Artery Forceps	179				
<b>Schoemaker-Ogilvie</b>					
Clamps	10				
<b>Schroeder</b>					
Dental Pliers	129				
Vulsellum Forceps	85				
<b>Schubert</b>					
Biopsy Punch	71				
<b>Schuknecht</b>					
Aural Instruments	186				
<b>Scissors</b>					
Abel	96				
Alar	232				
Aufricht	41				
Barnes	80				
Bowel	41				
Braun-Stadler	80				
Cairns	155				
Campbell	232				
Capsulotomy	175				
Carless	42				
Cartilage	41				
Cawthorne	208				
Chassar Moir	80				
Chiropody	137				
Currie Uterine	81				
Dental	131				
Dissecting	42				
Doyen	42				
Dressing	42,43				
Elliot Iris	43				
Enucleation	44				
Fergusson	44				
Glasgow Iris	44				
Goligher	96				
Heaths	44				
Iris	45				
Kilner	233				
Knight (Heymann)	209				
Lagrange	45				
Lister	45				
Littauer	46				
Lloyd-Davies	96				
McKissock	155				
Mayo	46				
Metzenbaum	47				
Monaghan	81				
Nelson Lobectomy	48				



<b>Scissors (cont)</b>					
Ormerod	209	<b>Shears</b>		<b>Splinter Forceps</b>	
Parks	96	Pollocks	31	Arthur	55
Paynes Suture	48	Rib	31	Hunter	55
Portmann	209	Skull	31	Martin	55
Post Mortem	48	Swedish Laminectomy	155	<b>Sponge Holding Forceps</b>	
Potts Smith	68	<b>Siegle (Peters)</b>		Foerster	56
Scott Stevenson	209	Aural Specula	187	Ramplcy	56
Spencer	49	<b>Sigmoidoscopes</b>		<b>Spring Clip</b>	176
Stevens	48,49	Inflation Bellows	97	<b>Stamm</b>	
Strabismus	49	Lloyd-Davies	97	Bone Cutting Forceps	159
Umbilical	81	<b>Silver</b>		<b>Stanley Boyd</b>	
Universal Bandage	49	Chisels	220	Bone Curettes	157
Universal Wire Cutting	49	Skin Graft Knives	235	<b>Staple Instruments</b>	
Uterine	82	<b>Simpson</b>		Blount	176
Vant	82	Obstetric Forceps	77	<b>Steinmann</b>	
Wilson	209	<b>Sims</b>		Pin Introducer	171
Woods	209	Curettes	75	<b>Steriliser Forceps</b>	
<b>Scissors, Hard Edge</b>		Sounds	83	Cheatles	56
Dressing	50	Vaginal Specula	84	<b>Stethoscopes</b>	
Iris	51	<b>Sinus Forceps</b>		Binaural	56
Mayo	51	Lister	55	Nurse	56
Mayo-Stille	51	<b>Sinus Probes</b>	32	Pinard Foetal	83
Metzenbaum	51,52	<b>Skin Graft Boards</b>	234	<b>Stevens</b>	
Nelson Lobectomy	52	<b>Skin Graft Knives</b>		Scissors	48,49
Potts Smith	69	Braithwaite	235	Scissors, Ultracutting	54
Strabismus	52	Cobbett	235	<b>Stiles</b>	
Universal Wire Cutting	52	Silver	235	Tissue Forceps	59
<b>Scissors, Ultra-Cutting</b>		Watson	235	<b>Stille-Lorenz</b>	
Dressing	53	<b>Skin Hooks</b>		Shears	30
Iris	53	Gillies	235	<b>Stirrups</b>	
Kilner	53	Kilner	235	Bohler	176
Mayo	53	McIndoe	235	<b>Stone Forceps</b>	
Mayo Stille	54	<b>Smillie</b>		Randall Renal Calculus	89
Metzenbaum	54	Hook Retractors	173	<b>Strabismus</b>	
Stevens	54	Menisectomy Knives	167	Scissors	49
Strabismus	54	<b>Smith Petersen</b>		Scissors, Hard Edge	52
<b>Scoops</b>		Chisels	163	Scissors, Ultra-Cutting	54
Lempert	210	Gouges	165	<b>Suction Tubes</b>	
<b>Scott Stevenson</b>		Osteotomes	170	Adson Frazier	155
Scissors	209	<b>Sommerlad</b>		American	57
<b>Sellers</b>		Mapping Pens	223	Barron	210
Rib Spreaders	68	<b>Sounds</b>		Bellucci	210
<b>Semb</b>		Galabin	83	Cut-Out Adaptor	211
Clamps	63	Horrocks	83	Falconer	155
<b>Septum Forceps</b>		Sims	83	Formby	210
Asch	233	<b>Spackman</b>		Gillies	83
Jansen-Middleton	233	Cannula, Intra Uterine	72	House	210
Walsham	234	<b>Spatulas Dental</b>	127	Lempert	211
<b>Seymour Jones</b>		<b>Spencer</b>		Magill	211
Punch Forceps	207	Scissors	49	Poole	57
<b>Shardle</b>		<b>Spencer-Wells</b>		Self-Clearing	211
Towel Clips	59	Artery Forceps	6	Tinckler (Simpson Smith)	57
<b>Sharman</b>		<b>Sphygmomanometers</b>		Verhoeven	211
Curettes	75	Aneriod	55	Yankauer	57
<b>Shea</b>		<b>Spinal Elevators</b>	164	Zoellner	212
Aural Forceps	182	<b>Spine Wrench</b>		<b>Sulleys</b>	
		Post Mortem	32	Tubing Clamps	60



<b>Suture Forceps</b>					
Charnley	177				
Guy's	57				
Mustarde	236				
<b>Swann Morton</b>					
Scalpels	39,40				
<b>Swedish</b>					
Chisels	163				
Dissectors	143				
Gouges	165				
Osteotomes	170				
Shears, Laminectomy	155				
<b>Syme</b>					
Dissectors	193				
Needles	29				
<b>Syringe</b>					
Aspirating	133				
Aural	212				
Bacon	212				
Cartridge	133				
<b>T</b>					
<b>Tabb Crura</b>					
Aural Forceps	183				
<b>Teales</b>					
Vulsellum Forceps	85				
<b>Tenotomy Knives</b>	167,168				
<b>Thompson-Walker</b>					
Needleholders	25				
Needleholders, TC	28				
Pedicle Clamps	88				
Penile Clamps	88				
<b>Thudichum</b>					
Nasal Specula	203				
<b>Thwaites</b>					
Nippers	137				
<b>Tilley</b>					
Aural Dressing Forceps	183				
Burs	189				
Gouges	194				
Nasal Forceps	199				
<b>Tilley Harpoon</b>					
Trocars	215				
<b>Tilley Henckel</b>					
Punch Forceps	207				
<b>Tilley Lichtwitz</b>					
Trocars	215				
<b>Tinckler (Simpson Smith)</b>					
Suction Tubes	57				
<b>Tissue Forceps</b>					
Allis	58				
Babcock	58				
DeBakey	69				
<b>Tissue Forceps (cont)</b>					
Duval	58				
Judd-Allis	58				
Lanes	58				
Littlewood	58				
Poirier	58				
Rutherford Morison	59				
Stiles	59				
<b>Toffee Hammer</b>	223				
<b>Tongue Depressors</b>					
Flat	213				
Lack	213				
<b>Tongue Forceps</b>					
Collin	213				
Guy's	59				
Mayo	59				
Young	213				
<b>Tongue Plates</b>					
Mouth Gags	198				
<b>Tonsil Holding Forceps</b>					
Denis Browne	214				
<b>Tonsil Snare</b>					
Eve	214				
<b>Towel Clips</b>					
Backhaus	59				
Frenchay	59				
Shardle	59				
<b>Tracheal Dilators</b>					
Trousseau	214				
<b>Tracheal Hook</b>					
Retractors	35				
<b>Tracheostomy Tubes</b>					
Chevalier Jackson	215				
Negus	215				
<b>Trautmann</b>					
Myringotomes	199				
<b>Travers</b>					
Retractors, Self Retaining	37				
<b>Trethowan</b>					
Bone Levers	162				
<b>Treves</b>					
Dissecting Forceps	19				
<b>Trocars</b>					
Tilley Harpoon	215				
Tilley Lichtwitz	215				
<b>Trotter</b>					
Rongeurs	154				
<b>Trousseau</b>					
Tracheal Dilators	214				
<b>Tubby</b>					
File	164				
Tenotomy Knives	168				
<b>Tubing Clamps</b>					
Sulleys	60				
Wedge Jaw	60				
<b>Tudor Edwards</b>					
Elevators, Periosteal	66				
Lung Retractors	67				
Rib Shears	67				
<b>Tuffier</b>					
Rib Spreaders	68				
<b>Tumarkin</b>					
Aural Specula	187				
<b>Tuning Forks</b>					
Alloy	216				
Gardiner Brown	216				
Hartmann	216				
<b>Turbinate Forceps</b>					
Grunwald	216				
Irwin Moore	217				
Luc	217				
<b>Turner-Warwick</b>					
Diathermy Scissors	15				
<b>Turn-Over-End</b>					
Dissecting Forceps	19				
<b>Tweezers, Dental</b>					
College	132				
Dressing	132				
Furnace	132				
Guttman	132				
Perry	132				
Plugging	132				
Self-Locking	132				
<b>U</b>					
<b>Umbilical</b>					
Scissors	81				
<b>Universal Bandage Scissors</b>	49				
<b>Universal Pliers</b>	129				
<b>Universal Wire Cutting</b>					
Scissors	49				
Scissors, Hard Edge	52				
<b>Uterine</b>					
Scissors	82				
<b>Uterine Forceps</b>					
Bonney	83				
<b>V</b>					
<b>Vaginal Specula</b>					
Auvard	84				
Cusco	84				
Graves	84				
Sims	84				
<b>Van Doren</b>					
Biopsy Punch	71				



<b>Van Havre (Sargent)</b>	
Rongeurs	154
<b>Vant</b>	
Scissors	82
<b>Vasectomy</b>	
Clamps	60
Forceps	60
<b>Verbrugge</b>	
Bone Holding Forceps	161
<b>Verhoeven</b>	
Suction Tubes	211
<b>Volkmann</b>	
Bone Curettes	157
Retractors	35
<b>Vulsellum Forceps</b>	
Lewer	85
Luer	85
Schroeder Uterine	85
Teales	85

## W

<b>Walsham</b>	
Septum Forceps	234
<b>Walton</b>	
Retractors	35
<b>Ward</b>	
Bone Cutting Forceps	219
Chisels	220
Elevators	222
Needleholders	25
Osteotomes	228
Retractors	232
<b>Warwick James</b>	
Elevators	101
<b>Watson</b>	
Skin Graft Knives	235
<b>Watson Cheyne</b>	
Dissectors	20
<b>Watson-Williams</b>	
Nasal Rasp	201
<b>Waugh</b>	
Diathermy Forceps	14
Dissecting Forceps	20
<b>Wax Knives</b>	128
<b>Webster</b>	
Needleholder, TC	28
<b>Weislander</b>	
Retractors, Self-Retaining	37
<b>Weitlaner</b>	
Retractors, Self-Retaining	37
<b>Welster</b>	
Needleholders	28
<b>Wertheim</b>	
Retractors	79

<b>West</b>	
Retractors, Self-Retaining	37
<b>Wilde</b>	
Aural Dressing Forceps	184
<b>Wilson</b>	
Artery Forceps	179
Pituitary Forceps	205
Scissors	209
<b>Wilson Hey</b>	
Diathermy Forceps	14
<b>Winters</b>	
Root Elevators	102
<b>Wire Cutters</b>	236
<b>Wire Forceps</b>	
Hayton Williams	236
Lawson Tait	236
<b>Wire Instruments</b>	
Handle	177
Loute	177
Pliers	177

<b>Wittner</b>	
Biopsy Punch	71
<b>Woakes</b>	
Eustachian Catheters	189
<b>Woods</b>	
Scissors	209
<b>Wool Carriers</b>	
Heath	217
Musgrove	217
<b>Wrigley</b>	
Obstetric Forceps	77

## Y

<b>Yankauer</b>	
Suction Tubes	57
<b>Yeomans</b>	
Biopsy Forceps	91
<b>Young</b>	
Tongue Forceps	213

## Z

<b>Zoellner</b>	
Suction Tubes	212