

PRODUCTS



NONINVASIVE
VENTILATION AND
OXYGENATION
MONITORING



sentec

ADVANCING NONINVASIVE
PATIENT MONITORING

WELCOME

CONTENT

SDMS

SenTec Digital Monitoring System with PO ₂ (SDMS-PO2)	4
SenTec Digital Monitoring System without PO ₂ (SDMS)	5
Starter Set	6
SenTec Digital Monitor	7
V-Sign™ Sensor 2 / OxiVenT™ Sensor	8
Digital Sensor Adapter Cable	9

DISPOSABLES

Multi-Site Attachment Ring for sensitive, fragile skin	10
Multi-Site Attachment Ring for mature, intact skin	10
Staysite™ Adhesive for MAR	10
Ear Clip for mature, intact skin	11
Contact Gel	11
Service Gas	11
Membrane Changer	12
Membrane Changer Insert	12
Membrane Changer Set	12

DATA MANAGEMENT / REMOTE MONITORING

V-STATS™ Installation CD	13
V-CareNeT™ Package Registration Code	13
Data Management Accessories	14

MANUALS

Quick Reference Guide for «SDMS»	15
Instruction Manual for «SDMS»	15
User Manuals CD	15

CABLES/INTERFACING

PSG Adapter Cables for the SenTec Digital Monitor	16
Nurse Call Cable Universal	17
VueLink Adapter	17
Dräger Infinity Adapter	17

ACCESSORIES

Membrane Changer Training Set	18
«SDMS» Carry Bag	18
Clothing Clip for Sensor Cable	19
Cable Cleat & Bin for Disposables	19
Roll Stand	20
Mounting Plate for infusion stands and wall railings	21
Mounting Plate for wall railings	21
Mounting Plate for Roll Stand Heads	21
Potential Equilization Cable	22

SENTEC DIGITAL MONITORING SYSTEM with PO₂ (SDMS-PO2)

PRODUCT CODES: «SDMS-PO2», «SDMS-N-PO2», «SDMS_nG-PO2», or «SDMS-N_nG-PO2»

4 |



PATIENT MONITORING SYSTEM FOR tcPCO₂, tcPO₂, SpO₂, Pulse Rate and Relative Heating Power (RHP)
 The SDMS-PO2 consists of the following main components:

- 1 SenTec Digital Monitor with activated PO₂ channel (SDM-PO2)
- 1 OxiVenT™ Sensor (OV-A/P/N)
- 1 Digital Sensor Adapter Cable (AC-150)
- 1 Starter Set (see table below)

Depending on the Product Code used one of the four available «Starter Sets» will be shipped:

Product Code	Starter Set to be shipped	Comment
SDMS-PO2	SSET	Standard Starter Set (with Service Gas)
SDMS-N-PO2	SSET-N	Neonatal Starter Set (with Service Gas)
SDMS_nG-PO2	SSET_nG	Standard Starter Set (without Service Gas)
SDMS-N_nG-PO2	SSET-N_nG	Neonatal Starter Set (without Service Gas)

For details on contained items see corresponding Product Codes.

NOTE:

- «SDMS-PO2» and «SDMS-N-PO2» each contain 1 bottle «Service Gas» (a pressurized container) and therefore are considered as dangerous goods when shipped. Costs related to handling of dangerous goods during shipment (in particular for air freight) may arise.
- Gas bottles are pressurized containers. «SDMS-PO2», «SDMS-N-PO2», and «GAS-0812» therefore are considered as dangerous goods. «GAS 0812» contains 6 gas bottles whereas «SDMS-PO2» or «SDMS-N-PO2» contain only 1 gas bottle. The costs per gas bottle that are related to handling of dangerous goods during shipment (in particular for air freight) therefore are higher when ordering 1 «SDMS-PO2» or 1 «SDMS-N-PO2» as compared to ordering 1 «SDMS_nG-PO2» and 1 «GAS-0812» or 1 «SDMS-N_nG-PO2» and 1 «GAS-0812», respectively.



SENTEC DIGITAL MONITORING SYSTEM without PO₂ (SDMS)

PRODUCT CODES: «SDMS», «SDMS-N», «SDMS_nG», or «SDMS-N_nG»



| 5

PATIENT MONITORING SYSTEM FOR tcPCO₂, SpO₂, Pulse Rate and Relative Heating Power (RHP)

The SDMS consists of the following main components:

- 1 SenTec Digital Monitor without activated PO₂ channel (SDM)
- 1 V-Sign™ Sensor 2 (VS-A/P/N)
- 1 Digital Sensor Adapter Cable (AC-150)
- 1 Starter Set (see table below)

Depending on the Product Code used one of the four available «Starter Sets» will be shipped:

Product Code	Starter Set to be shipped	Comment
SDMS	SSET	Standard Starter Set (with Service Gas)
SDMS-N	SSET-N	Neonatal Starter Set (with Service Gas)
SDMS_nG	SSET_nG	Standard Starter Set (without Service Gas)
SDMS-N_nG	SSET-N_nG	Neonatal Starter Set (without Service Gas)

For details on contained items see corresponding Product Codes.

NOTE:

- «SDMS» and «SDMS-N» each contain 1 bottle «Service Gas» (a pressurized container) and therefore are considered as dangerous goods when shipped. Costs related to handling of dangerous goods during shipment (in particular for air freight) may arise.
- Gas bottles are pressurized containers. «SDMS», «SDMS-N», and «GAS-0812» therefore are considered as dangerous goods. «GAS-0812» contains 6 gas bottles whereas «SDMS» or «SDMS-N» contain only 1 gas bottle. The costs per gas bottle that are related to handling of dangerous goods during shipment (in particular for air freight) therefore are higher when ordering 1 «SDMS» or 1 «SDMS-N» as compared to ordering 1 «SDMS_nG» and 1 «GAS-0812» or 1 «SDMS-N_nG» and 1 «GAS-0812», respectively.

STARTER SET

PRODUCT CODES: «SSET», «SSET-N», «SSET_nG», or «SSET-N_nG»

6 |



Ear Clip (EC-MI)
for mature, intact skin

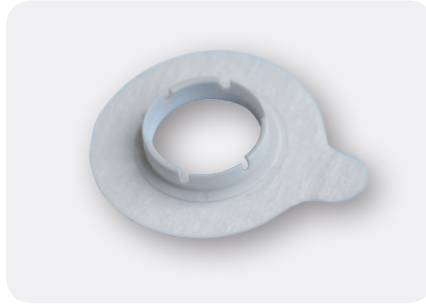

Multi-Site Attachment Ring (MAR-MI)
for mature, intact skin

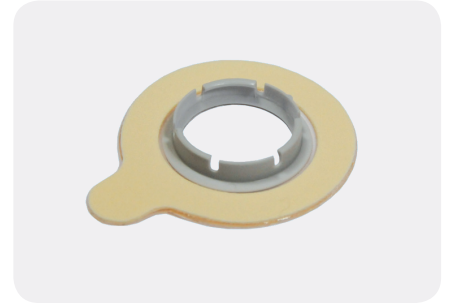

Multi-Site Attachment Ring (MAR-SF)
for sensitive, fragile skin



Contact Gel (GEL-04)



Membrane Changer (reloadable) (MC-R)



Service Gas (GAS-0812)

SET OF DISPOSABLES, COVERING APPROXIMATELY ONE MONTH'S NEED

Four different «Starter Set» configurations are available (quantities indicate number of individual items):

Product Code	Standard Starter Set		Neonatal Starter Set	
	SSET	SSET_nG	SSET-N	SSET-N_nG
Ear Clips (EC-MI)	12	12	-	-
Multi-Site Attachment Rings (MAR-MI)	12	12	8	8
Multi-Site Attachment Rings (MAR-SF)	4	4	16	16
Membrane Changer (reloadable) (MC-R)	2	2	2	2
Contact Gel (GEL-04)	1	1	1	1
Service Gas (GAS-0812)	1	-	1	-

NOTE:

- «SSET» and «SSET-N» each contain 1 bottle «Service Gas» (a pressurized container) and therefore are considered as dangerous goods. Costs related to handling of dangerous goods during shipment (in particular for air freight) may arise.
- Gas bottles are pressurized containers. «SSET», «SSET-N», and «GAS-0812» therefore are considered as dangerous goods. «GAS-0812» contains 6 gas bottles whereas «SSET» or «SSET-N» contain only 1 gas bottle. The costs per gas bottle that are related to handling of dangerous goods during shipment (in particular for air freight) therefore are higher when ordering 1 «SSET» or 1 «SSET-N» as compared to ordering 1 «SSET_nG» and 1 «GAS-0812» or 1 «SSET-N_nG» and 1 «GAS-0812», respectively.



SENTEC DIGITAL MONITOR

PRODUCT CODE: «SDM-PO2» or «SDM»



SDM-PO2 with activated PO₂ channel
for tcPCO₂, tcPO₂, SpO₂, PR and RHP monitoring



SDM without activated PO₂ channel
for tcPCO₂, SpO₂, PR and RHP monitoring

| 7

STAND-ALONE PATIENT MONITOR WITH INTEGRATED CALIBRATION CHAMBER

- For display of data measured with SenTec Sensors as specified in above pictures
- Physical characteristics:
 - Weight: 2.5 kg (5.5 lbs) - including gas cylinder
 - Size: 10.2 cm x 27.0 cm x 23.0 cm (4.00" x 10.63" x 9.06")
 - Flip feet serving as carrying handle or to adjust angle for improved table-top viewing
 - Mountable on roll/infusion stands, wall mounts/railings, transport incubators, etc.
- Interfaces:
 - Serial Output (RS-/EIA-232): Supported protocols: SenTecLink, Philips VueLink and/or Philips IntelliBridge, Spacelabs Flexport, Serial Printer, TCB (TransCutaneous Basic Protocol to connect e.g. to Dräger Monitoring)
 - LAN Port (UDP - RFC 768): Required for Remote Monitoring with V-CareNet™
 - Analog output (0-1 V)
 - Nurse-call capability
- TFT Color Display (LED backlight)
- Non volatile FLASH memory with capacity (monitoring data) of up to 227 hours (9.5 days)¹
- Rechargeable, sealed Lilon Battery with capacity of up to 16 hours²

NOTE:

- Above-mentioned features depend on Firmware Version of the «SDM-PO2» or «SDM»
- Contact your SenTec representative for tcPO₂ channel activation (Product Code: «SDM_PO2activation»)

¹ At 8-seconds resolution (34 hours at 1-second resolution)

² If Sleep Mode=ON

V-SIGN™ SENSOR 2

PRODUCT CODE: «VS-A/P/N»

8 |



CARBON DIOXIDE TENSION AND PULSE OXIMETRY SENSOR

- Digital Sensor
- Noninvasive and continuous measurement of $tcPCO_2$, pulse oximetry (SpO_2 , PR) and relative heating power (RHP)
- Suitable for adult, pediatric, and neonatal patients
- Reusable, waterproof
- To be attached to the patient with «MAR-MI», «MAR-SF» or Ear Clip
- Includes 1 single Clothing Clip (SC-CC)
- To be connected to the «SDM» with a «Digital Sensor Adapter Cable» (AC-XXX)

OxiVenT™ SENSOR

PRODUCT CODE: «OV-A/P/N»



CARBON DIOXIDE TENSION, OXIGEN TENSION AND PULSE OXIMETRY SENSOR

- Digital Sensor
- Noninvasive and continuous measurement of $tcPCO_2$, $tcPO_2$, pulse oximetry (SpO_2 , PR) and relative heating power (RHP)
- Suitable for adult, pediatric, and neonatal patients
- Reusable, waterproof
- To be attached to the patient with «MAR-MI», «MAR-SF» or Ear Clip
- Includes 1 single Clothing Clip (SC-CC)
- To be connected to the «SDM» with a «Digital Sensor Adapter Cable» (AC-XXX)

NOTE:

- Requires «SDM» firmware version SMB V08.00 / MPB V06.00 or newer



DIGITAL SENSOR ADAPTER CABLE

PRODUCT CODE: «AC-XXX»



ADAPTER CABLE REQUIRED TO CONNECT SENTEC TC SENSORS TO THE SENTEC DIGITAL MONITOR (SDM or SDM-PO2)

| 9

Product Code	Digital Sensor Adapter Cable
AC-150	Length = 150 cm / 59.1 "
AC-250	Length = 250 cm / 98.4 "
AC-750	Length = 750 cm / 295.3 "
AC-YYY	Customized Length (up to 920 cm / 362.2 ")

MULTI-SITE ATTACHMENT RING (24 PCS.)

PRODUCT CODE: «MAR-SF»

10 |

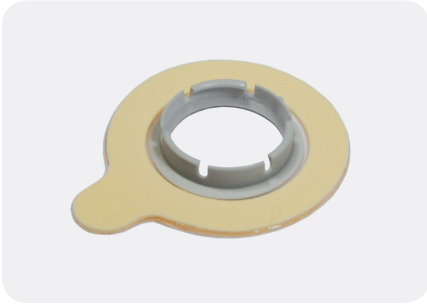

SINGLE-USE ATTACHMENT RING FOR USE WITH SENTEC TC SENSORS

- For attachment of SenTec TC Sensors to various measurement sites
- Suitable for
 - Neonatal, pediatric and adult patients
 - Sensitive (fragile) but intact skin

MULTI-SITE ATTACHMENT RING (50 PCS.)

PRODUCT CODE: «MAR-MI»



SINGLE-USE ATTACHMENT RING FOR USE WITH SENTEC TC SENSORS

- For attachment of SenTec TC Sensors to various measurement sites
- Suitable for
 - Adult, pediatric and neonatal patients
 - Mature, intact skin

STAYSITE™ ADHESIVE (50 PCS.)

PRODUCT CODE: «SA-MAR»



STAYSITE™ ADHESIVE FOR COMPLIMENTARY ATTACHEMNT OF MAR-MI/SF

- Additional adhesive film to improve fixation of MAR-MI/SF
- Suitable for
 - high humidity environments
 - challenging patient motion conditions
 - Neonatal, pediatric and adult patients



EAR CLIP (24 PCS.)

PRODUCT CODE: «EC-MI»



SINGLE-PATIENT USE EAR CLIPS FOR USE WITH SENTEC TC SENSORS

| 11

- For attachment of SenTec TC Sensors to the patient's earlobe³
- Suitable for
 - Adult, pediatric and neonatal patients
 - Mature, intact skin and earlobes of sufficient size

CONTACT GEL (5 ML)

PRODUCT CODE: «GEL-04»



CONTACT GEL FOR THE APPLICATION OF SENTEC TC SENSORS

- Viscous liquid
- For proper conduction of transcutaneous blood gases from the patient's skin to SenTec TC Sensors

NOTE:

- Instead of the Contact Gel you may also use clean tap water, sterile water or sterile saline solution

SERVICE GAS (6 BOTTLES)

PRODUCT CODE: «GAS-0812»



CALIBRATION GAS CYLINDER OF 0.56 l, 9.5 BAR (5.7 l AT 1 BAR, 21 °C / 69.8 °F)

- Required for the calibration of SenTec TC Sensors
- One Service Gas cylinder lasts up to 3 to 4 weeks (depending on usage of the «SDMS»)
- Components:
 - CO₂ (carbon dioxide)
 - O₂ (oxygen)
 - Balance N₂ (nitrogen)

NOTE:

- Pressurized containers are considered as dangerous goods. Costs related to handling of dangerous goods during shipment (in particular for air freight) may arise.

³ The use of the Ear Clip is contraindicated for patients whose earlobes are too small to ensure adequate sensor application.

MEMBRANE CHANGER (reloadable) (9 PCS.)

PRODUCT CODE: «MC-R»

12 |



RELOADABLE TOOL TO CHANGE THE MEMBRANE OF SENTEC TC SENSORS

- Membrane change process by 4 simple press-and-turn steps
 - Old sensor membrane removal
 - Sensor surface cleaning
 - Application of new electrolyte
 - Application of new sensor membrane
- Economic and cost saving due to «reloading option» with Membrane Changer Inserts (MC-I)

MEMBRANE CHANGER INSERT (5 PCS.)

PRODUCT CODE: «MC-I»



SEPARATELY BAGGED, SINGLE-USE INSERTS FOR THE MEMBRANE CHANGER

- Required to reload a used Membrane Changer prior reuse

MEMBRANE CHANGER SET

PRODUCT CODE: «MC-SET»



SET OF

- 1 Membrane Changer (loaded)
- 1 Membrane Changer Insert



V-STATS™ INSTALLATION CD

PRODUCT CODE: «V-STATS_CD»



PC BASED REMOTE MONITORING & TREND DATA DOWNLOAD/ ANALYSIS SOFTWARE FOR SENTEC DIGITAL MONITORS

| 13

The three main features of V-STATS™ are:

- Download of 'SDM Trend Data' stored in the internal memory of SenTec Digital Monitors for subsequent analysis, viewing and reporting, either via serial interface or with V-CareNet™ (see below).
- Configuration of SenTec Digital Monitors via serial interface:
a) configuration of all settings of the connected «SDM» on an individual basis (including special (safety-relevant) parameters that are not accessible in the menu of the «SDM»), b) storage of up to 4 'SDM Profiles' on the connected «SDM», and c) customization/ management of 'SDM Profiles'
- V-CareNet™ (function only available after activation of the V-CareNet™ Package being incorporated within V-STATS™ (see below)).

Currently supported languages: English, French, German, Italian and Spanish

V-CareNet™ PACKAGE REGISTRATION CODE

PRODUCT CODE: «V-STATS_CPRC_5», «V-STATS_CPRC_10», «V-STATS_CPRC_20», «V-STATS_CPRC_30» and «V-STATS_CPRC_40»

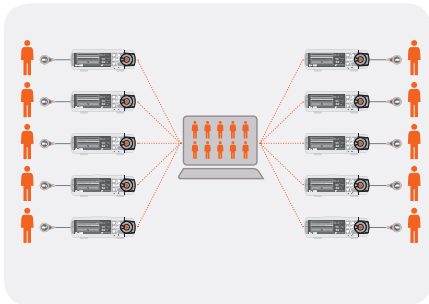

REMOTE MONITORING AND SECONDARY ALARM SURVEILLANCE SYSTEM⁴

What is the V-CareNet™ Package Registration Code?

- Code needed to activate V-CareNet™ Package for either 5, 10, 20, 30 or 40 beds/patients

Main Features of V-CareNet™

- Remote monitoring and secondary alarm surveillance for up to 40 SenTec Digital Monitors being connected to the same network as the PC with V-CareNet™
- Possibility to remotely set 'Operator Events' and 'PCO₂/SpO₂ Baselines' on the included SDMs during patient monitoring
- Remote control of certain settings of the included SDMs (Alarm Limits, Display Brightness, Display in Sleep Mode, Delta Time,...)
- Download of 'SDM Trend Data' stored in the internal memory of SenTec Digital Monitors for subsequent analysis, viewing and reporting. With V-CareNet™ download of 'SDM Trend Data' is simultaneously possible for multiple SDMs

⁴ As urged by APSF (Anesthesia Patient Safety Foundation)

DATA MANAGEMENT ACCESSORIES

PC AND PRINTER INTERFACE CABLES / ADAPTERS / ACCESSORIES

A number of accessories are available for data communication between the «SDM» and the PC or the «SDM» and a Seiko DPU-414 Thermal Printer.

14 |



Product Code

USB232C_180

USB232 Converter Cable (USB 2.0)

For data communication between the «SDM» and a PC with USB-port (e.g. to download data from the «SDM» or to configure special (safety-relevant) settings of the «SDM»).

Specification: length = 180 cm / 70.9 ", DB9 Male

System Requirements: IBM PC 486DX4-100 MHz CPU or higher or compatible system; Available USB port; CD-ROM drive; Windows 2000, Windows XP, Windows Vista, Windows 7, 8 and 8.1



No Product Code

shown here for illustration purpose only, no SenTec product

Serial RS232 Cable, DB9 Male / Female

For data communication between the «SDM» and a PC with RS232 port (DB9) (e.g. to download data from the «SDM» or to configure special (safety-relevant) settings of the «SDM»).

Specification: length = 180 cm / 70.9 " or 200 cm / 78.7 ", DB9 Male / Female

Note: This is a standard product - please purchase at your local IT supplier.



Product Code

SDMPrinter_C180

Printer Cable («SDM» to Seiko DPU-414 Thermal Printer)

To interface the «SDM» with the Seiko DPU-414 Thermal Printer if printing of trend data is required.

Specification: length = 180 cm / 70.9 "

Sample pictures



QUICK REFERENCE GUIDE FOR «SDMS»

PRODUCT CODE: «QRG-xx» (REPLACE xx WITH DESIRED LANGUAGE CODE)

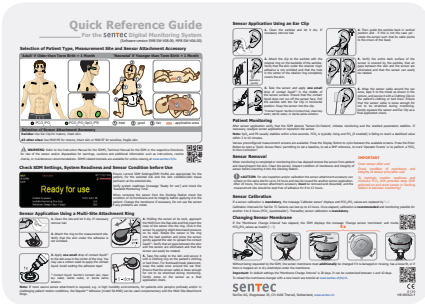

HARDCOPY OF QUICK REFERENCE GUIDE FOR «SDMS»

| 15

- Contact us for availability of languages

INSTRUCTION MANUAL FOR «SDMS»

PRODUCT CODE: «IM-xx» (REPLACE xx WITH DESIRED LANGUAGE CODE)



HARDCOPY OF INSTRUCTION MANUAL FOR «SDMS»

- Contact us for availability of languages

USER MANUALS CD

PRODUCT CODE: «UMCD»



CD CONTAINING PDF-VERSIONS OF ALL RELEVANT MANUALS RELATED TO THE «SDMS»

PSG ADAPTER CABLES FOR THE SENTEC DIGITAL MONITOR

16 |



Product Code

PSG Adapter Cables A - N

see QR-Code /link

Various ready-made adapter cables are currently available to interface the «SDM» to the most common PG or PSG systems. For more information please refer to the following link:

<http://www.sentec.ch/fileadmin/PSG/ProductInfoPSGAdapterCables.pdf>



Product Code

PSG Adapter Cable Universal

PSG-X

To interface of the «SDM» with Polygraphs (PG) or Polysomnographs (PSG).
Simple attachment of the open wires to the required plugs for the particular PG or PSG.

Specification: length = 180 cm / 70.9 ", open wires



Product Code

PSG Adapter Cables Demo Set

PSG-DEMO

Demo set for Sales Reps to demonstrate the interfacing of the SenTec Digital Monitor to most Polygraphic (PG) or Polysomnographic (PSG) Systems.
Comprises one base cable and extension cables A - N (see PSG Adapter cables above).



NURSE CALL CABLE UNIVERSAL

PRODUCT CODE: «NC-X»

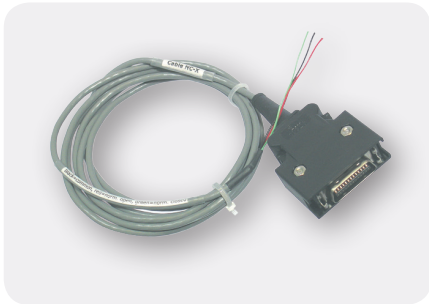

ADAPTER CABLE «SDM» TO NURSE CALL SYSTEM LENGTH 180 CM / 70.9", OPEN WIRES

| 17

- For interfacing of the «SDM» with most nurse call systems
- Simple attachment of the open wires to the required plugs for the particular nurse call system

VUELINK ADAPTER

PRODUCT CODE: «VL-A»

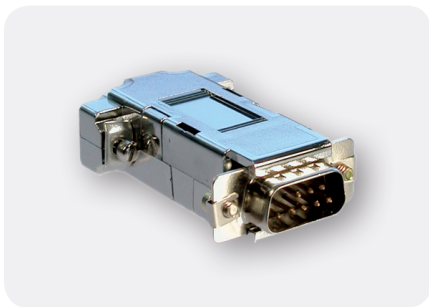

ADAPTER «SDM» TO PHILIPS VUELINK INTERFACE MODULE

- For Interfacing of the «SDM» with Philips Patient Monitors
- For display of «SDMS» measurement data on the main screen of the Philips Monitoring System

NOTE:

- Please verify your SDM's compatibility with your local distributor or with SenTec AG.
- The VueLink Adapter connects the «SDM» to a VueLink connection cable with D-SUB 9 connector and a VueLink Interface Module Auxiliary Plus (Type B) with Digital Open Interface Driver. Both are available at Philips dealers only.

DRÄGER INFINITY ADAPTER

PRODUCT CODE: «DI-A»



ADAPTER «SDM» TO DRÄGER MIB II CONVERTER

- For Interfacing of the «SDM» with Dräger Patient Monitors
- For display of «SDMS» measurement data on the main screen of the Dräger Medical Monitoring System

NOTE:

- Requires «SDM» firmware version SMB V07.01 / MPB V05.01 or newer

MEMBRANE CHANGER TRAINING SET

PRODUCT CODE: «MC-TSET»

18 |



SET TO TRAIN MEMBRANE CHANGE OF SENTEC TRANSCUTANEOUS SENSORS

- Set for training purposes on membrane change
- 1 multiple-use Membrane Changer
- 1 dummy sensor
- 2 multiple-use dummy membrane rings (colored in red)

«SDMS» CARRY BAG

PRODUCT CODE: «SDMS_CB»



CARRY BAG FOR THE SENTEC DIGITAL MONITORING SYSTEM

- Stylish yet sturdy and durable carry bag
- Specifically designed compartments for
 - SenTec Digital Monitor (SDM), sensors, cables (sensor adapter cables / power cable), gas bottle
 - Frequently used disposables and documents (Quick Reference Guide, Instruction Manual)
 - «SDM» can be kept switched «on» during transportation
- Zipper top can be opened for monitoring during patient transport
- Velcro^{®5} bottom which can be quickly pulled open to access the monitor's rear panel
- Two gauze covered ventilation slots
- General specifications
 - Size: 340 x 285 x 150 mm / 1.3 " x 1.1 " x 0.6 "
 - Weight: 1.56 kg or 3.44 lb
 - Color: grey
 - Material: hard-wearing nylon (padded)
 - Sturdy, adjustable shoulder strap (removable)

⁵ Velcro[®] is a registered trademark owned by Velcro Industries B.V.



CLOTHING CLIP FOR SENSOR CABLE (2 PCS.)

PRODUCT CODE: «SC-CC»



CLIP FOR FIXATION OF THE CABLE OF SENTEC SENSORS ON PATIENT CLOTHES OR BED LINEN

| 19

- Proper cable organization to help to reduce strain
- Helps to prevent dislocation of the sensor when attached to the patient
- Suitable for all SenTec sensors

CABLE CLEAT & BIN FOR DISPOSABLES

PRODUCT CODES: «CC_SDM», «CC_BFD»

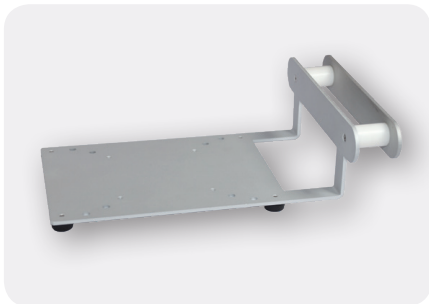

Cable Cleat (CC_SDM)



«SDM» with Cable Cleat



Bin for Disposables (CC_BFD)



«SDM» with Cable Cleat and Bin for Disposables

Product Code

CC_SDM

CC_BFD

Product

Cable Cleat for SenTec Digital Monitor

Bin for Disposables (to be mounted on Cable Cleat for «SDM»)

- Sensor cable and disposables stowage
- Protection of sensor cable from damage or breakage
- Can be used together with the Roll Stand (please order special screws separately)

ROLL STAND FOR THE SENTEC DIGITAL MONITOR

PRODUCT CODE: «RS_SDM»

20 |



ROLL STAND FOR THE SENTEC DIGITAL MONITOR WITH BASKET AND CABLE CLEAT

- Mobile mounting option for your monitor
- Durable and lightweight
- With locking castors and a pivoting head allowing adjustment for enhanced viewing
- Attached basket accommodates additional supplies as well as storage for the sensor cable
- Can be used together with the Cable Cleat (please order special screws separately)



MOUNTING PLATE FOR INFUSION STANDS AND WALL RAILINGS

PRODUCT CODE: «MP-IW»

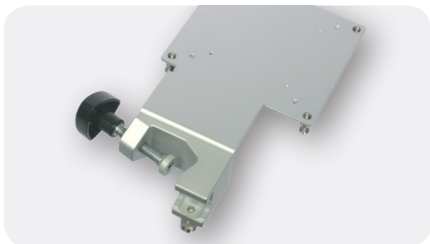

UNIVERSAL MOUNTING PLATE FOR FIXATION OF «SDM» TO INFUSION STANDS AND WALL RAILINGS

| 21

- For «SDM» fixation to infusion stands or other rigid tubes or poles with diameters from 12 mm to 38 mm / 0.5 " to 1.5 ", or to wall railings with standard dimensions of 25 mm / 1 " height and 10 mm / 0.4 " thickness

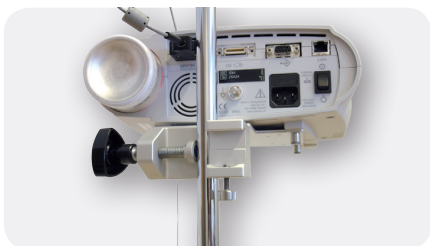

MOUNTING PLATE FOR WALL RAILINGS

PRODUCT CODE: «MP-WR»

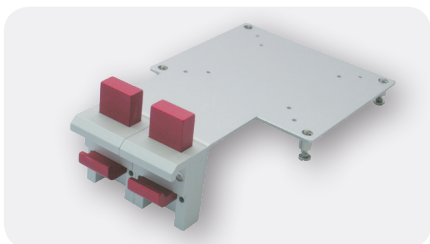

MOUNTING PLATE FOR FIXATION OF «SDM» TO WALL RAILINGS

- For «SDM» fixation to wall railings with standard dimensions of 25 mm to 35 mm / 1 " to 1.4 " height and 8 mm to 10 mm / 0.3 " x 0.4 " thickness

MOUNTING PLATE FOR ROLL STAND HEADS & ADAPTER PLATES

PRODUCT CODE: «MP-RSH»

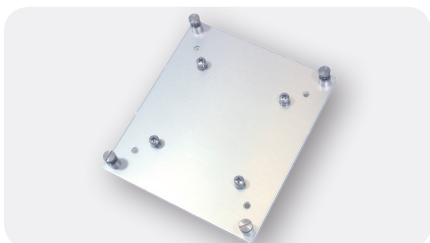

MOUNTING PLATE FOR FIXATION OF «SDM» TO ROLL STAND HEADS OR ADAPTER PLATES

- Compatible with GCX-Vesa 75 to 100 mm Adapter Plate and GCX POLYMOUNT roll stand



POTENTIAL EQUILIZATION CABLE

PRODUCT CODE: «POT-300»

22 |



POTENTIALLY COMPENSATED HOSPITAL EQUIPMENT CABLE FOR CATEGORY 3 AND 4 MEDICAL EXAMINATION ROOMS TÜV TESTED

- Highly flexible connecting leads with green-yellow insulation for potential equalization
- On both ends with assembled right-angled, spring-loaded socket
- Sockets made of nickel-lated brass with Multilam made of gold-plated, hard drawn copper alloy

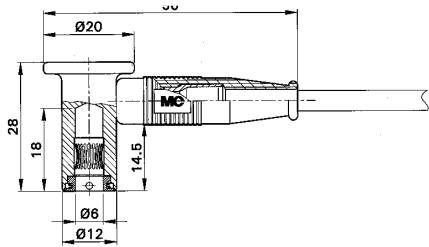

Specifications:

- Length: 300 cm / 118.1 "
- Lead cross section: 4.0 mm² / 0.02 square inch
- Sleeve Insulation: TPE



**PLEASE CONTACT US,
IF YOU HAVE ANY QUESTIONS!**

SenTec uses reasonable efforts to report information accurately and comprehensively in the Catalogue. SenTec assumes no liability or responsibility for any errors or omissions in the content of the Catalogue, including the accuracy, completeness, timeliness, reliability or availability of any information you receive as a result of your use of the Catalogue. Statements in the Catalogue may depend on the respective Software- and/or Hardwareversion of the products.

This document and all statements and specifications therein are subject to change without notice.

