



Product Catalog

SunMed

Ventlab

Ethox



[Airway Management](#) | [Resuscitation/Ventilation](#) | [Anesthesia](#) | [Respiratory](#) | [Emergency](#) | [Oxygen Delivery](#) | [Diagnostics](#) | [Surgical](#)

www.Sun-Med.com | 800-433-2797



Welcome!

SunMed Core Values

Our values reflect in our culture and in our work:

- *Genuine Appreciation for our Customers and Staff*
- *Teamwork*
- *Quality and Continuous Improvement*
- *Dignity and Respect for our Staff*
- *Adaptability*



SunMed, LLC

2710 Northridge Dr. NW, Suite A

Grand Rapids, MI 49544 USA

www.Sun-Med.com

800-433-2797 | 616-259-8400

616-647-3430 fax

info@Sun-Med.com





*Dedicated to Healthcare
Professionals Since 1981*

Anesthesia and respiratory clinicians depend on SunMed products daily.

SunMed is proud to be an American company. We are an FDA registered, ISO-13485 certified manufacturer and distributor of high quality medical devices for use in hospitals and healthcare facilities worldwide. Our product family includes airway management, anesthesia, respiratory, resuscitation/ ventilation, diagnostics, oxygen delivery and surgical care products. In addition to the SunMed brand, Ventlab and Ethox Medical branded products are part of our family.

We are rapidly growing with new, innovative products that promote better patient care. Serving the healthcare industry in over 40 countries, we seek to address the needs of clinicians worldwide.

SunMed Customer Promise

We will deliver the following to each and every customer, business partner and, ultimately, the healthcare professional who selects and uses our products.

We promise to:

- Treat each customer with respect and kindness;*
- Strive to fully understand the unique needs of our customers;*
- Provide timely responses and solutions;*
- Be flexible and adaptable to the changing needs of our customers and the standard of care;*
- Identify opportunities for our customers to succeed;*
- Supply high-quality, safe, effective and compliant products;*
- Build a genuine, trusted relationship with you.*

SunMed Quality Statement

SunMed is committed to excellence and the highest level of customer satisfaction for all products and processes. We are committed to the delivery and support of safe and effective anesthesia, respiratory and urology devices through:

Excellence *We are dedicated to providing the quality of excellence through teamwork, leadership, open communication and continuous improvement to achieve the company's objectives and meet our customer's expectations. Continuously improve the effectiveness of our Quality Management System that delivers compliant and sustainable products, processes and systems.*

Customers *We will adapt to customers changing needs at all times in an environment of continuous improvement of high quality products and services.*

Products *We distribute products that are safe, reliable and in compliance with applicable U.S. and International regulatory requirements, standards and regulations.*



Find What You Need

TABLE OF CONTENTS

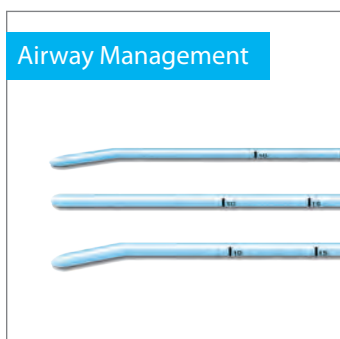

- 8-23
- Oropharyngeal Airways
- Nasopharyngeal Airways
- Endotracheal Tubes
- Endobronchial Tubes
- Tracheostomy Tubes
- ET Connectors
- Intubation Aids
- Airway Accessories

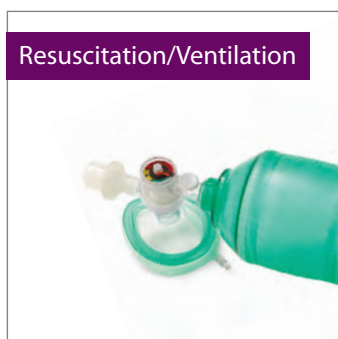

- 24-41
- Resuscitators / Ventilators
- Hyperinflation Systems
- Breathing Filters
- Circuits
- Resuscitation Accessories



- 42-99
- Fiber Optic Laryngoscopes
- Conventional Laryngoscopes
- Masks
- Pressure Infusion
- Anesthesia Accessories



- 100-121
- Cannulas
- Masks
- Circuits
- Respiratory Devices
- Breathing Filters
- Valved Holding Chamber
- Medical Gas Fittings
- O2 Flow Meters
- Respiratory Accessories



Product Catalog



Emergency



122-139

- Airways
- Intubation Aids
- Resuscitators / Ventilators
- Gastric Lavage
- Wound Irrigation
- Emergency Accessories

Oxygen Delivery



140-151

- O2 Flow Meters
- Cannulas
- Masks
- Circuits
- Oxygen Delivery Accessories

Diagnostics



152-161

- Diagnostic Devices
- Stethoscopes
- ETCO2 Cannulas
- Diagnostic Accessories

Surgical



162-169

- Patient Safety
- Instruments
- Catheters
- Surgical Accessories

Your source for high quality products from

SunMed

Ventlab

Ethox



AIRWAY MANAGEMENT



- 8-10 Oropharyngeal Airways
- 12-13 Nasopharyngeal Airways
- 14-16 Endotracheal Tubes
- 17 Endobronchial Tubes
- 17 Tracheostomy Tubes
- 18-19 ET Connectors
- 20-23 Intubation Aids

SunMed

Ventlab

Ethox

Oropharyngeal Airway

BERMAN

LATEX FREE | SINGLE USE | DISPOSABLE

SunMed



- Firm, polyethylene plastic
- Vented septum
- Built-in bite block
- Sets are ideal for crash carts
- Individually wrapped

INDIVIDUAL

CAT#	SIZE	DESCRIPTION	COLOR	PK
1-1508-40	4cm / 40mm	Newborn	Pink	10
1-1508-50	5cm / 50mm	Infant	Blue	10
1-1508-60	6cm / 60mm	Small Child	Black	10
1-1508-70	7cm / 70mm	Child	White	10
1-1508-80	8cm / 80mm	Small Adult	Green	10
1-1508-90	9cm / 90mm	Medium Adult	Yellow	10
1-1508-99	10cm / 100mm	Large Adult	Red	10
1-1508-11	11cm / 110mm	X-Large Adult	Orange	10
1-1506-40	4cm / 40mm	Newborn	Pink	50
1-1506-50	5cm / 50mm	Infant	Blue	50
1-1506-60	6cm / 60mm	Small Child	Black	50
1-1506-70	7cm / 70mm	Child	White	50
1-1506-80	8cm / 80mm	Small Adult	Green	50
1-1506-90	9cm / 90mm	Medium Adult	Yellow	50
1-1506-99	10cm / 100mm	Large Adult	Red	50
1-1506-11	11cm / 110mm	X-Large Adult	Orange	50

SETS

CAT#	SIZES INCLUDE	PK
1-1508-00	40mm, 50mm, 60mm, 70mm, 80mm, 90mm, 100mm, 110mm (1 of each size per set; 10 sets per pack)	10 Sets

Oropharyngeal Airway

TRADITIONAL GUEDEL

LATEX FREE | SINGLE USE | DISPOSABLE

SunMed



- Firm, polyethylene plastic
- One piece construction
- Built-in bite block
- Sets are ideal for crash carts
- Bulk packaged

INDIVIDUAL

CAT#	SIZE	DESCRIPTION	COLOR	PK
1-1501-50	5cm	Infant, 50mm	Blue	10
1-1501-60	6cm	Small Child, 60mm	Black	10
1-1501-70	7cm	Child, 70mm	White	10
1-1501-80	8cm	Small Adult, 80mm	Green	10
1-1501-90	9cm	Med. Adult, 90mm	Yellow	10
1-1501-99	10cm	Large Adult, 100mm	Red	10
1-1500-50	5cm	Infant, 50mm	Blue	50
1-1500-60	6cm	Small Child, 60mm	Black	50
1-1500-70	7cm	Child, 70mm	White	50
1-1500-80	8cm	Small Adult, 80mm	Green	50
1-1500-90	9cm	Med. Adult, 90mm	Yellow	50
1-1500-99	10cm	Large Adult, 100mm	Red	50

SETS

CAT#	SIZES INCLUDED	PK
1-1501-00	50, 60, 70, 80, 90, 100mm (1 of each size per set/pack)	1 Set



Oropharyngeal Airway
COLOR CODED GUEDEL

LATEX FREE | SINGLE USE | DISPOSABLE



- Firm, polyethylene plastic
- Built-in bite block
- Sets are ideal for crash carts
- Individually wrapped

INDIVIDUAL

CAT#	SIZE	DESCRIPTION	COLOR	PK
1-1504-40	4cm	Newborn, 40mm	Pink	10
1-1504-50	5cm	Infant, 50mm	Blue	10
1-1504-60	6cm	Small Child, 60mm	Black	10
1-1504-70	7cm	Child, 70mm	White	10
1-1504-80	8cm	Small Adult, 80mm	Green	10
1-1504-90	9cm	Med. Adult, 90mm	Yellow	10
1-1504-99	10cm	Large Adult, 100mm	Red	10
1-1504-11	11cm	X-Large Adult, 110mm	Orange	10
1-1505-40	4cm	Newborn, 40mm	Pink	50
1-1505-50	5cm	Infant, 50mm	Blue	50
1-1505-60	6cm	Small Child, 60mm	Black	50
1-1505-70	7cm	Child, 70mm	White	50
1-1505-80	8cm	Small Adult, 80mm	Green	50
1-1505-90	9cm	Med. Adult, 90mm	Yellow	50
1-1505-99	10cm	Large Adult, 100mm	Red	50
1-1505-11	11cm	X-Large Adult, 110mm	Orange	50

SETS

CAT#	SIZES INCLUDED	PK
1-1504-00	40, 50, 60, 70, 80, 90, 100, 110mm (1 of each size per set/pack)	1 Set

Oropharyngeal Airway
PVC GUEDEL

LATEX FREE | SINGLE USE | DISPOSABLE



- Soft, clear PVC plastic
- Built-in bite block
- Sets are ideal for crash carts
- Individually wrapped

INDIVIDUAL

CAT#	SIZE	DESCRIPTION	COLOR	PK
1-5010-30	3cm	Premature, 30mm	Clear	10
1-5010-20	4cm	Newborn, 40mm	Pink	10
1-5010-10	5cm	Infant, 50mm	Blue	10
1-5010-01	6cm	Small Child, 60mm	Black	10
1-5010-02	7cm	Child, 70mm	White	10
1-5010-03	8cm	Small Adult, 80mm	Green	10
1-5010-04	9cm	Med. Adult, 90mm	Yellow	10
1-5010-05	10cm	Large Adult, 100mm	Red	10
1-5010-06	11cm	X-Large Adult, 110mm	Orange	10
1-1521-30	3cm	Premature, 30mm	Clear	50
1-1521-20	4cm	Newborn, 40mm	Pink	50
1-1521-10	5cm	Infant, 50mm	Blue	50
1-1521-01	6cm	Small Child, 60mm	Black	50
1-1521-02	7cm	Child, 70mm	White	50
1-1521-03	8cm	Small Adult, 80mm	Green	50
1-1521-04	9cm	Med. Adult, 90mm	Yellow	50
1-1521-05	10cm	Large Adult, 100mm	Red	50
1-1521-06	11cm	X-Large Adult, 110mm	Orange	50

SETS

CAT#	SIZES INCLUDED	PK
1-5010-98	30, 40, 50, 60, 70, 80, 90, 100, 110mm (1 of each size per set/pack)	1 Set



Oropharyngeal Airway

WILLIAMS

LATEX FREE | SINGLE USE | DISPOSABLE

SunMed



- Guides fiber optic bronchoscopy placement
- Built-in bite block
- Bulk package

CAT#	SIZE	DESCRIPTION	PK
1-1503-09	9cm	Adult Female	10
1-1503-10	10cm	Adult Male	10

Patient Safety

BITE BLOCK

LATEX FREE | SINGLE USE | DISPOSABLE

Ethox



- Assists with naso-gastric tube placement
- Accommodates up to a 40Fr tube
- Individually packaged

CAT#	DESCRIPTION	PK
2060	Bite Block	50

Patient Safety

TOOTH PROTECTOR

LATEX FREE | SINGLE USE | DISPOSABLE

SunMed



- Helps prevent broken or chipped teeth during intubation, bronchoscopy, laryngoscopy, tonsillectomy, and tooth extraction
- Minimizes tooth injury

CAT#	DESCRIPTION	PK
9-3041-03	Adult Tooth Protector	50

Patient Safety

JAW SPREADER

LATEX FREE | SINGLE USE | DISPOSABLE

SunMed



- Helps facilitate breathing during convulsions or seizures
- Universal design firmly holds the tongue down while keeping jaw open in both children and adults
- Complete kit includes:
 - Jaw spreader (fits child through adult)
 - Pediatric (6cm) and adult (9cm) Berman airways with bite block
- Dependable, durable construction – will not break or splinter even under extreme pressure

CAT#	DESCRIPTION	PK
9-3042-00	Jaw Spreader Kit	1



Intubation

INTUBATION KIT

LATEX FREE



Complete intubation kits available with conventional, fiber optic or fiber optic disposable laryngoscope blades

Each kit includes:

- 8 Oropharyngeal color coded Guedel airways (sizes 40mm-100mm)
- 1 Penlite chrome plated fiber optic laryngoscope handle
- 1 Medium chrome plated fiber optic laryngoscope handle
- 5 Miller laryngoscope blades (sizes 0-4)
- 4 Macintosh laryngoscope blades (sizes 1-4)
- 4 Extra laryngoscope lamps (2 small, 2 large)
- 1 Adult Magill forceps
- 1 Pediatric Magill forceps
- 2 "C" batteries
- 2 "AA" batteries
- 4 Packets of sterile lubricating jelly
- 2 Endotracheal uncuffed tubes (sizes 2.5, 4mm)
- 8 Endotracheal cuffed tubes (sizes 5-10mm)
- 4 Nasopharyngeal airways (sizes 20, 24, 28, 32Fr)
- 1 10ml syringe
- 1 Endotracheal tube introducer (bougie) with coudé tip
- 1 Adult stylette
- 1 Nylon airway management case

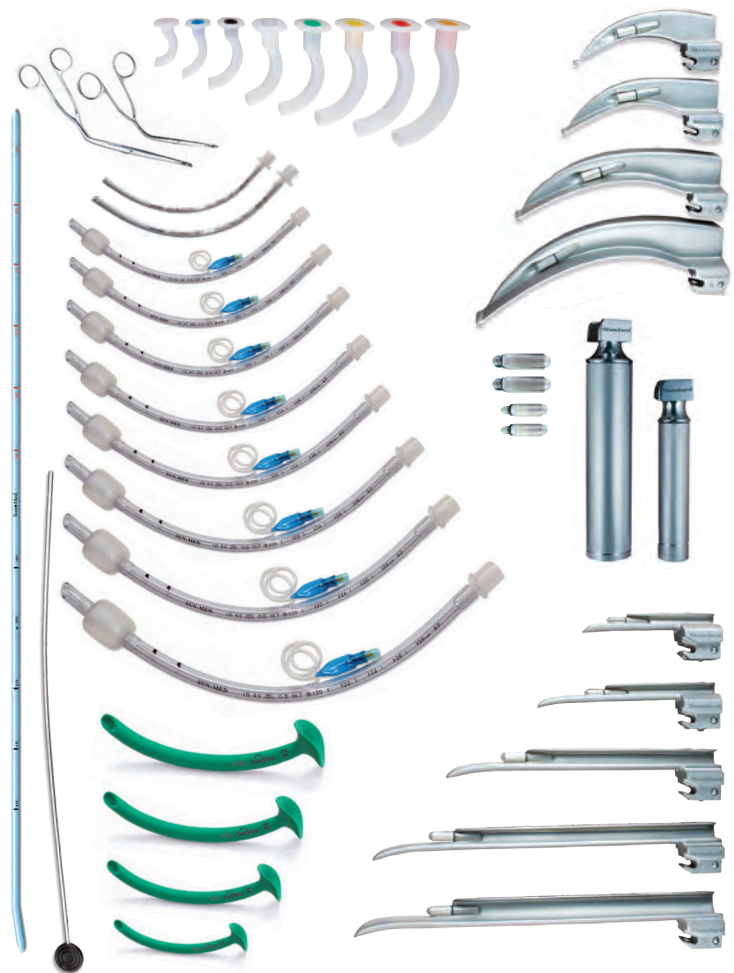

CAT#	KIT INCLUDES	PK
8-1050-95	Fiber Optic Intubation Kit Includes items above + Reusable FO Laryngoscope Blades	1 Kit
8-1050-94	Single-Use Fiber Optic Intubation Kit Includes items above + Disposable FO Single Use Laryngoscope Blades	1 Kit
8-1050-85	Conventional Intubation Kit Includes items above + Conventional Laryngoscope Blades	1 Kit
8-1050-80	Nylon Case Only	1

8-1050-95 Fiber Optic Intubation Kit
Batteries, lubricating jelly, and syringe not shown.



Nasopharyngeal Airway

LATEX FREE ROBERTAZZI

STERILE | LATEX FREE | SINGLE USE | DISPOSABLE

SunMed



- Flexible neoprene performs like latex airways
- Soft material prevents damage to nasal passage
- Blunt tip
- Resists collapse or kinking
- Packaged with large size and specification notation for accurate selection
- Sets are ideal for crash carts
- Individually sterile packaged

INDIVIDUAL

CAT#	SIZE	ID	OD	LENGTH	PK
1-5075-20	20Fr	5.0mm	6.7mm	115mm	10
1-5075-22	22Fr	5.5mm	7.3mm	120mm	10
1-5075-24	24Fr	6.0mm	7.6mm	120mm	10
1-5075-26	26Fr	6.5mm	8.6mm	130mm	10
1-5075-28	28Fr	7.0mm	9.3mm	135mm	10
1-5075-30	30Fr	7.5mm	10.0mm	135mm	10
1-5075-32	32Fr	8.0mm	10.7mm	145mm	10
1-5075-34	34Fr	8.5mm	11.2mm	160mm	10
1-5075-36	36Fr	9.0mm	12.0mm	175mm	10

SETS

CAT#	SIZES INCLUDED	PK
1-5075-04	20, 24, 28, 32Fr (1 of each size per set/pack) + sterile lubricating jelly	1 Set
1-5075-06	22, 24, 26, 28, 30, 32Fr (1 of each size per set/pack) + sterile lubricating jelly	1 Set
1-5075-09	20, 22, 24, 26, 28, 30, 32, 34, 36Fr (1 of each size per set/pack) + sterile lubricating jelly	1 Set

Nasopharyngeal Airway

ADJUSTABLE AIRWAY

STERILE | LATEX FREE | SINGLE USE | DISPOSABLE

SunMed



- Flexible neoprene performs like latex airways
- Soft material prevents damage to nasal passage
- Soft, adjustable flange
- Blunt tip
- Resists collapse or kinking
- Individually sterile packaged

INDIVIDUAL

CAT#	SIZE	ID	OD	LENGTH	PK
1-5072-12	12Fr	3.0mm	4.0mm	95mm	10
1-5072-14	14Fr	3.5mm	4.7mm	95mm	10
1-5072-16	16Fr	4.0mm	5.3mm	95mm	10
1-5072-18	18Fr	4.5mm	6.0mm	95mm	10
1-5072-20	20Fr	5.0mm	6.7mm	115mm	10
1-5072-22	22Fr	5.5mm	7.3mm	120mm	10
1-5072-24	24Fr	6.0mm	7.6mm	120mm	10
1-5072-26	26Fr	6.5mm	8.6mm	130mm	10
1-5072-28	28Fr	7.0mm	9.3mm	170mm	10
1-5072-30	30Fr	7.5mm	10.0mm	170mm	10
1-5072-32	32Fr	8.0mm	10.7mm	170mm	10
1-5072-34	34Fr	8.5mm	11.2mm	170mm	10
1-5072-36	36Fr	9.0mm	12.0mm	170mm	10



Nasopharyngeal Airway
LATEX ROBERTAZZI

STERILE | LATEX | SINGLE USE | DISPOSABLE

SunMed



- Processed to reduce latex protein
- Smooth surface for easy insertion
- Soft, flexible design reduces trauma to nasal passage
- Blunt tip
- Resists collapse or kinking
- Sets are ideal for crash carts
- Individually sterile packaged

INDIVIDUAL

CAT#	SIZE	ID	OD	LENGTH	PK
1-5076-20	20Fr	5.0mm	6.7mm	115mm	10
1-5076-22	22Fr	5.5mm	7.3mm	120mm	10
1-5076-24	24Fr	6.0mm	7.6mm	120mm	10
1-5076-26	26Fr	6.5mm	8.6mm	130mm	10
1-5076-28	28Fr	7.0mm	9.3mm	135mm	10
1-5076-30	30Fr	7.5mm	10.0mm	135mm	10
1-5076-32	32Fr	8.0mm	10.7mm	150mm	10
1-5076-34	34Fr	8.5mm	11.2mm	160mm	10
1-5076-36	36Fr	9.0mm	12.0mm	175mm	10

SETS

CAT#	SIZES INCLUDED	PK
1-5076-04	20, 24, 28, 32Fr (1 of each size per set/pack) + sterile lubricating jelly	1 Set
1-5076-06	22, 24, 26, 28, 30, 32Fr (1 of each size per set/pack) + sterile lubricating jelly	1 Set
1-5076-09	20, 22, 24, 26, 28, 30, 32, 34, 36Fr (1 of each size per set/pack) + sterile lubricating jelly	1 Set

Nasopharyngeal Airway
PVC AIRWAY

STERILE | LATEX FREE | SINGLE USE | DISPOSABLE

SunMed

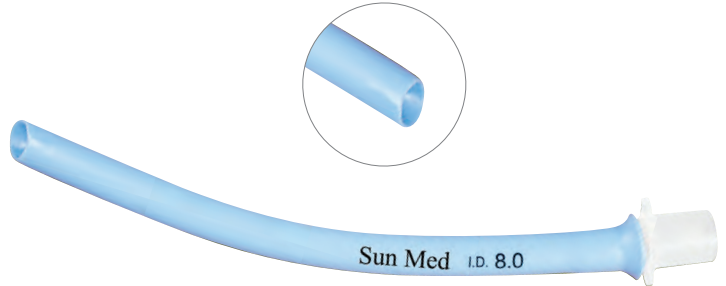

- Smooth surface for easy insertion
- Beveled tip
- Standard 15mm Fitting
- Packaged with large size and specification notation for accurate selection
- Sets are ideal for crash carts
- Individually sterile packaged

INDIVIDUAL

CAT#	SIZE	ID	OD	LENGTH	PK
1-5073-12	12Fr	3.0mm	4.0mm	75mm	10
1-5073-14	14Fr	3.5mm	4.7mm	90mm	10
1-5073-16	16Fr	4.0mm	5.3mm	105mm	10
1-5073-18	18Fr	4.5mm	6.0mm	115mm	10
1-5073-20	20Fr	5.0mm	6.7mm	120mm	10
1-5073-22	22Fr	5.5mm	7.3mm	125mm	10
1-5073-24	24Fr	6.0mm	8.0mm	140mm	10
1-5073-26	26Fr	6.5mm	8.7mm	145mm	10
1-5073-28	28Fr	7.0mm	9.3mm	155mm	10
1-5073-30	30Fr	7.5mm	10.0mm	160mm	10
1-5073-32	32Fr	8.0mm	10.7mm	180mm	10
1-5073-34	34Fr	8.5mm	11.3mm	185mm	10
1-5073-36	36Fr	9.0mm	12.0mm	195mm	10

SETS

CAT#	SIZES INCLUDED	PK
1-5073-05	20, 24, 28, 32, 36Fr (1 of each size per set/pack) + sterile lubricating jelly	1 Set



Endotracheal Tube

MURPHY EYE

STERILE | LATEX FREE | SINGLE USE | DISPOSABLE



- Oral and nasal use
- Clear, flexible PVC
- Smooth Murphy Eye for alternative ventilation port
- Available cuffed, uncuffed, reinforced and with stylette
- Economical
- High volume, low pressure cuff
- Large barrel cuff
- Standard 15mm ISO connector
- Reinforced version features a curved, stainless steel spiral

Textured aluminum, low friction stylette slides freely in and out of tube

15mm Adapter with wings and knurling facilitates connector removal when rocking adapter loose

Tapered ID inside connector reduces flow turbulence into tube

Ultra-secure adapter helps prevent disconnection

Polished 45° beveled tip helps reduce trauma on insertion

Polished Murphy Eye facilitates ventilation if tip becomes occluded

No ridge at transition of cuff to tube for more gentle insertion and removal at vocal cords

Gas tight female luer slip inflation valve to be inflated by a device with male luer fitting

Sensitive pilot balloon indicates status of cuff

Radiopaque embedded strip enables tube position detection with x-ray

Bold cm depth markings are easy to read in low light conditions

Crystal clear PVC allows immediate detection of foreign material in tube

Clearly visible mm OD and ID size markings helps proper tube size selection

Two positioning marks aid in correct tube depth

Barrel cuff with generous surface area lowers pressure in trachea capillaries while minimizing folds in cuff

Low pressure, high volume cuff provides a secure, comfortable seal in trachea

One-handed cuff inflation bulb quickly inflates/deflates cuff without the use of syringe; designed with one-way check valve

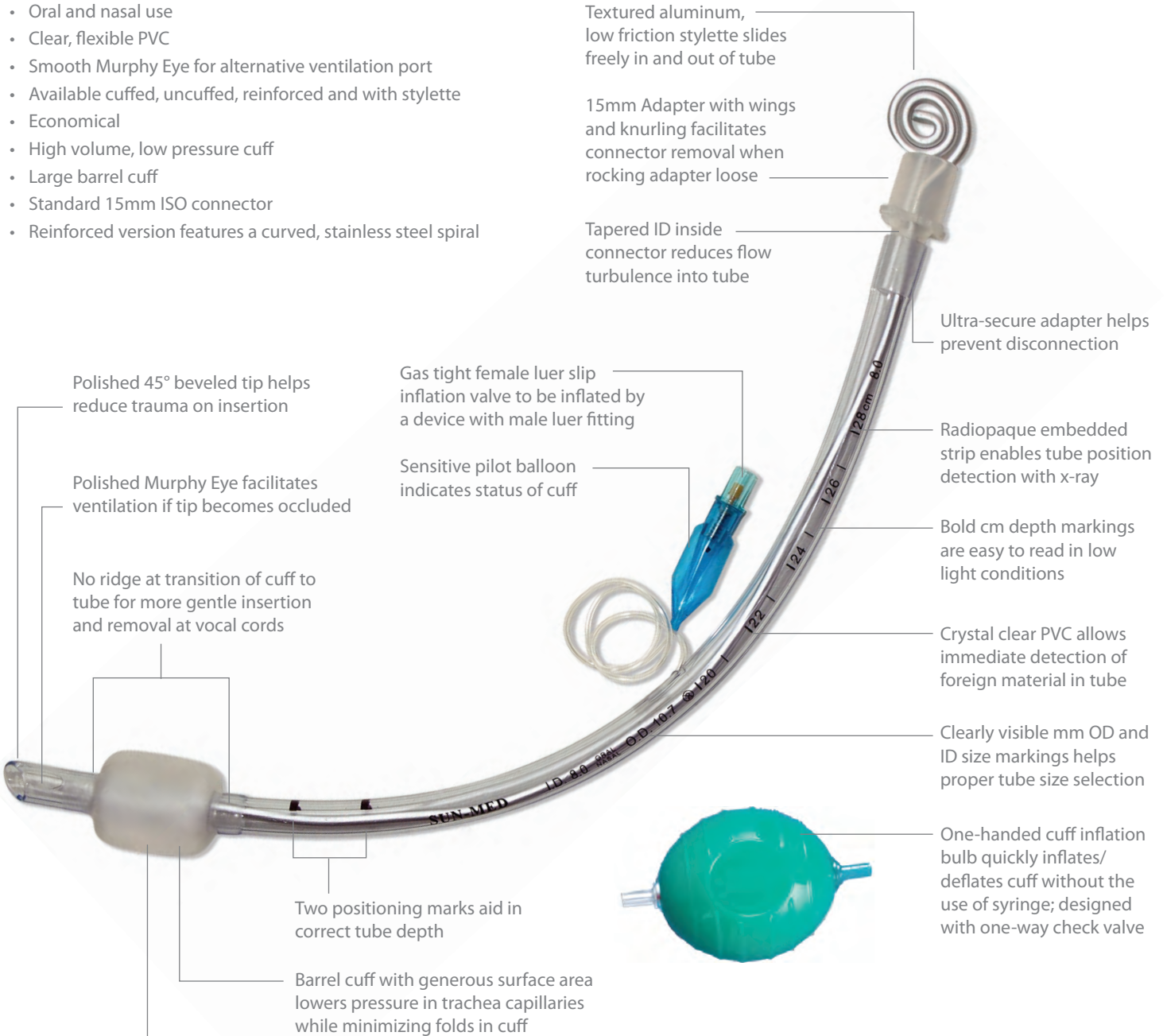

CUFF INFLATION BULB

CAT#	DESCRIPTION	PK
4-0101-00	Cuff Inflation Bulb Latex Free, Non-Sterile	10





UNCUFFED

CAT#	ID	SIZE	LENGTH	PK
1-7330-20	2.0mm	8Fr	140mm	10
1-7330-25	2.5mm	10Fr	145mm	10
1-7330-30	3.0mm	12Fr	165mm	10
1-7330-35	3.5mm	14Fr	185mm	10
1-7330-40	4.0mm	16Fr	210mm	10
1-7330-45	4.5mm	18Fr	225mm	10
1-7330-50	5.0mm	20Fr	245mm	10
1-7330-55	5.5mm	22Fr	275mm	10



CUFFED

CAT#	ID	SIZE	LENGTH	PK
1-7333-25	2.5mm	10Fr	150mm	10
1-7333-30	3.0mm	12Fr	165mm	10
1-7333-35	3.5mm	14Fr	185mm	10
1-7333-40	4.0mm	16Fr	210mm	10
1-7333-45	4.5mm	18Fr	225mm	10
1-7333-50	5.0mm	20Fr	245mm	10
1-7333-55	5.5mm	22Fr	275mm	10
1-7333-60	6.0mm	24Fr	285mm	10
1-7333-65	6.5mm	26Fr	295mm	10
1-7333-70	7.0mm	28Fr	310mm	10
1-7333-75	7.5mm	30Fr	315mm	10
1-7333-80	8.0mm	32Fr	330mm	10
1-7333-85	8.5mm	34Fr	330mm	10
1-7333-90	9.0mm	36Fr	330mm	10
1-7333-95	9.5mm	38Fr	330mm	10
1-7333-10	10.0mm	40Fr	330mm	10



CUFFED WITH STYLETTE

CAT#	ID	SIZE	LENGTH	PK
1-7343-30	3.0mm	12Fr	165mm	10
1-7343-35	3.5mm	14Fr	185mm	10
1-7343-40	4.0mm	16Fr	210mm	10
1-7343-45	4.5mm	18Fr	225mm	10
1-7343-50	5.0mm	20Fr	245mm	10
1-7343-55	5.5mm	22Fr	275mm	10
1-7343-60	6.0mm	24Fr	285mm	10
1-7343-65	6.5mm	26Fr	295mm	10
1-7343-70	7.0mm	28Fr	310mm	10
1-7343-75	7.5mm	30Fr	315mm	10
1-7343-80	8.0mm	32Fr	330mm	10
1-7343-85	8.5mm	34Fr	330mm	10
1-7343-90	9.0mm	36Fr	330mm	10
1-7343-95	9.5mm	38Fr	330mm	10
1-7343-10	10.0mm	40Fr	330mm	10



REINFORCED CUFFED

CAT#	ID	SIZE	LENGTH	PK
1-7363-35	3.5mm	14Fr	185mm	10
1-7363-40	4.0mm	16Fr	210mm	10
1-7363-45	4.5mm	18Fr	225mm	10
1-7363-50	5.0mm	20Fr	245mm	10
1-7363-55	5.5mm	22Fr	275mm	10
1-7363-60	6.0mm	24Fr	285mm	10
1-7363-65	6.5mm	26Fr	295mm	10
1-7363-70	7.0mm	28Fr	310mm	10
1-7363-75	7.5mm	30Fr	315mm	10
1-7363-80	8.0mm	32Fr	330mm	10
1-7363-85	8.5mm	34Fr	330mm	10
1-7363-90	9.0mm	36Fr	330mm	10
1-7363-95	9.5mm	38Fr	330mm	10
1-7363-10	10.0mm	40Fr	330mm	10



Endotracheal Tube

ORAL PREFORMED (AGT)(RAE)

STERILE | LATEX FREE | SINGLE USE | DISPOSABLE

SunMed

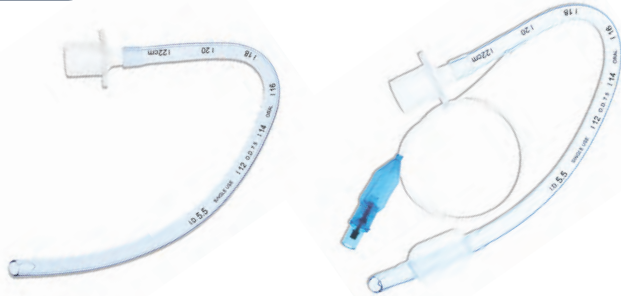

- Designed to direct tube downward to rest on patient's chin
- Allows circuit to be positioned out of surgical field; ideal for oral and maxillofacial surgery applications
- Polished Murphy Eye
- 15mm Male fitting included
- High volume, low pressure cuff
- Valve with sensitive pilot balloon indicating cuff status
- Radiopaque strip
- Smooth beveled tip for atraumatic introduction

UNCUFFED

CAT#	ID	SIZE	LENGTH	PK
1-7320-30	3.0mm	12Fr	120mm	10
1-7320-35	3.5mm	14Fr	130mm	10
1-7320-40	4.0mm	16Fr	140mm	10
1-7320-45	4.5mm	18Fr	150mm	10
1-7320-50	5.0mm	20Fr	160mm	10
1-7320-55	5.5mm	22Fr	170mm	10

CUFFED

CAT#	ID	SIZE	LENGTH	PK
1-7321-40	4.0mm	16Fr	140mm	10
1-7321-45	4.5mm	18Fr	150mm	10
1-7321-50	5.0mm	20Fr	160mm	10
1-7321-55	5.5mm	22Fr	170mm	10
1-7321-60	6.0mm	24Fr	190mm	10
1-7321-65	6.5mm	26Fr	210mm	10
1-7321-70	7.0mm	28Fr	230mm	10
1-7321-75	7.5mm	30Fr	240mm	10
1-7321-80	8.0mm	32Fr	250mm	10
1-7321-85	8.5mm	34Fr	260mm	10
1-7321-90	9.0mm	36Fr	270mm	10

Endotracheal Tube

NASAL PREFORMED (AGT)(RAE)

STERILE | LATEX FREE | SINGLE USE | DISPOSABLE

SunMed



- Designed to direct tube over patient's forehead, reducing pressure on nares
- Allows circuit to be positioned out of surgical field; ideal for oral and maxillofacial surgery applications
- Polished Murphy Eye
- 15mm Male fitting included
- High volume, low pressure cuff
- Valve with sensitive pilot balloon indicating cuff status
- Radiopaque strip
- Smooth beveled tip for atraumatic introduction

UNCUFFED

CAT#	ID	SIZE	LENGTH	PK
1-7322-30	3.0mm	12Fr	160mm	10
1-7322-35	3.5mm	14Fr	180mm	10
1-7322-40	4.0mm	16Fr	200mm	10
1-7322-45	4.5mm	18Fr	220mm	10
1-7322-50	5.0mm	20Fr	240mm	10
1-7322-55	5.5mm	22Fr	270mm	10

CUFFED

CAT#	ID	SIZE	LENGTH	PK
1-7323-40	4.0mm	16Fr	200mm	10
1-7323-45	4.5mm	18Fr	220mm	10
1-7323-50	5.0mm	20Fr	240mm	10
1-7323-55	5.5mm	22Fr	270mm	10
1-7323-60	6.0mm	24Fr	280mm	10
1-7323-65	6.5mm	26Fr	290mm	10
1-7323-70	7.0mm	28Fr	300mm	10
1-7323-75	7.5mm	30Fr	310mm	10
1-7323-80	8.0mm	32Fr	320mm	10



Endobronchial Tube
DUAL LUMEN

STERILE | LATEX FREE | SINGLE USE | DISPOSABLE

SunMed



- Color coded clear (tracheal) and blue (bronchial) for easy differentiation of appropriate lumen, pilot balloon and cuff
- Soft PVC
- High volume, low pressure cuff
- Radiopaque strip
- Graduated depth marks
- Suction catheter included
- Bronchial stylette included
- 15mmY- connector included with each tube

LEFT

CAT#	SIZE	DESCRIPTION	PK
1-7370-35	35Fr	Robertshaw Left	1
1-7370-37	37Fr	Robertshaw Left	1
1-7370-39	39Fr	Robertshaw Left	1
1-7370-41	41Fr	Robertshaw Left	

RIGHT

CAT#	SIZE	DESCRIPTION	PK
1-7371-35	35Fr	Robertshaw Right	1
1-7371-37	37Fr	Robertshaw Right	1
1-7371-39	39Fr	Robertshaw Right	1
1-7371-41	41Fr	Robertshaw Right	1

Tracheostomy Tube
TRACHEOSTOMY

STERILE | LATEX FREE | SINGLE USE | DISPOSABLE

SunMed



- Obturator and tube clearly marked
- 15mm Connector swivel adapter
- Soft PVC
- Secure neck band retainer
- Cushion neck band comfortable for patient
- Radiopaque strip embedded for exact location of tube
- Low pressure cuff

UNCUFFED

CAT#	ID	SIZE	LENGTH	PK
1-7390-30	3.0mm	12Fr	160mm	10
1-7390-35	3.5mm	14Fr	180mm	10
1-7390-40	4.0mm	16Fr	200mm	10
1-7390-45	4.5mm	18Fr	220mm	10
1-7390-50	5.0mm	20Fr	240mm	10

CUFFED

CAT#	ID	SIZE	LENGTH	PK
1-7393-50	5.0mm	20Fr	240mm	10
1-7393-55	5.5mm	22Fr	270mm	10
1-7393-60	6.0mm	24Fr	280mm	10
1-7393-65	6.5mm	26Fr	290mm	10
1-7393-70	7.0mm	28Fr	300mm	10
1-7393-75	7.5mm	30Fr	310mm	10
1-7393-80	8.0mm	32Fr	320mm	10
1-7393-85	8.5mm	34Fr	320mm	10
1-7393-90	9.0mm	36Fr	320mm	10
1-7393-95	9.5mm	38Fr	320mm	10
1-7393-10	10.0mm	40Fr	320mm	10



ET Tube Connector

RACINE UNIVERSAL CONNECTOR

LATEX FREE | REUSABLE

SunMed



- Allows movement of breathing circuit at patient end
- Eliminates the need for connectors of varying types and sizes
- Patented diaphragm allows quick and easy tube insertion which provides a firm, tight seal
- Aluminum and silicone construction
- Fits 7mm to 10.5mm tubes

CAT#	DESCRIPTION	PK
3-3013-03	4" Racine Universal Connector	1

ET Tube Connector

SYNTHETIC RUBBER CONNECTOR

LATEX FREE | REUSABLE

SunMed



- 15mm (M) x 15mm (F)
- Steam autoclavable
- Delrin fitting on both ends
- Lightweight

CAT#	DESCRIPTION	PK
3-0046-03	3" Synthetic Rubber Connector	1
3-0046-06	6" Synthetic Rubber Connector	1
3-0046-09	9" Synthetic Rubber Connector	1
3-0046-13	13" Synthetic Rubber Connector	1

ET Tube Connector

FLEXIBLE METAL ADAPTER

LATEX FREE | REUSABLE

SunMed



- 15mm (M) x 15mm (F)
- Permits positioning of tracheal tube Y-piece and tube connectors at any convenient angle
- Low 15ml dead space
- Chrome plated brass

CAT#	DESCRIPTION	PK
3-0186-15	4.75" Flexible Metal Adapter	1



FOR COMPLETE
Customer Service
Technical Information
Care/Cleaning Instructions
Product Literature

CALL
800-433-2797

VISIT
www.Sun-Med.com

EMAIL
info@Sun-Med.com



ET Tube Connector

STAINLESS STEEL CONNECTORS

LATEX FREE | REUSABLE

SunMed



STRAIGHT

CAT#	DESCRIPTION	PK
3-3100-40	4mm x 15mm (M)	1
3-3100-50	5mm x 15mm (M)	1
3-3100-60	6mm x 15mm (M)	1
3-3100-70	7mm x 15mm (M)	1
3-3100-80	8mm x 15mm (M)	1
3-3100-90	9mm x 15mm (M)	1



ACUTE 60° NO PORT

CAT#	DESCRIPTION	PK
3-3101-40	4mm x 15mm (M)	1
3-3101-50	5mm x 15mm (M)	1
3-3101-60	6mm x 15mm (M)	1
3-3101-70	7mm x 15mm (M)	1
3-3101-80	8mm x 15mm (M)	1
3-3101-90	9mm x 15mm (M)	1



90° NO PORT

CAT#	DESCRIPTION	PK
3-3120-40	4mm x 15mm (M)	1
3-3120-50	5mm x 15mm (M)	1
3-3120-60	6mm x 15mm (M)	1
3-3120-70	7mm x 15mm (M)	1
3-3120-80	8mm x 15mm (M)	1
3-3120-90	9mm x 15mm (M)	1



T-ADAPTER (TIB)

- For introducing or sampling gases from the breathing system
- 22mm (F) x 22mm (M)
- Male connection features tubing size 0.25" nipple inside

CAT#	DESCRIPTION	PK
3-0196-00	T-Adapter (TIB)	1



FLETCHER T-TUBE

- Effective for use with prematures, newborns and infants
- 15mm female fittings at both ends

CAT#	DESCRIPTION	PK
3-0200-15	Fletcher T-Tube	1



CORRUGATED CONNECTOR

- Stainless steel coupling for 22mm corrugated tubes
- May be used to connect breathing bags with 22mm necks to 22mm corrugated tubes
- 22mm (M) x 22mm (M)

CAT#	DESCRIPTION	PK
3-0183-22	Corrugated Connector	1



SUMMERS T-TUBE

- Eliminates dead space with incoming gases
- Converts to all standard 15mm connections into Y-pieces for simple conversion to the circle filter technique
- 15mm (F) patient end x 15mm (M)

CAT#	DESCRIPTION	PK
3-0194-15	4" Summer T-Tube	1



ELBOW

- Chrome plated brass Hanks-Rackow elbow
- 15mm (M) machine end
- Patient end is nominal 22mm O.D. x 15mm I.D.

CAT#	DESCRIPTION	PK
3-0169-00	Elbow	1



WASHINGTON T-TUBE

- Similar to Fletcher T-Tube
- 15mm (F) patient end x 15mm (M)
- Turns any size corrugated breathing tube (with proper adapters) into an exhalation tube for older children and adults

CAT#	DESCRIPTION	PK
3-0201-15	Washington T-Tube	1



Introducer

BOUGIE

STERILE | LATEX FREE | SINGLE USE | DISPOSABLE

SunMed



- Low density polyethylene provides proper stiffness for ease of insertion
- Calibrated to ensure accurate distance insertion
- Pediatric size features calibrated markings on both ends allowing it to be used as a straight or coudé tip
- Pediatric size fits in 4mm to 6mm tubes
- Adult size fits in 6mm to 11mm tubes

CAT#	SIZE	DESCRIPTION	PK
9-0211-70	10Fr x 70cm	Pediatric, Coudé Tip	10
9-0212-70	15Fr x 70cm	Adult, Coudé Tip	10
9-0212-72	15Fr x 70cm	Adult, Straight Tip	10

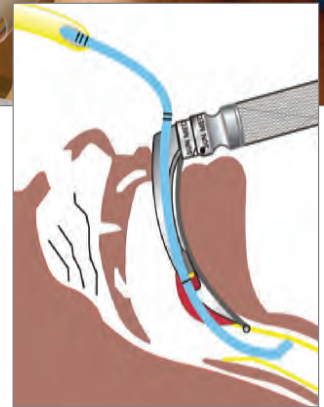
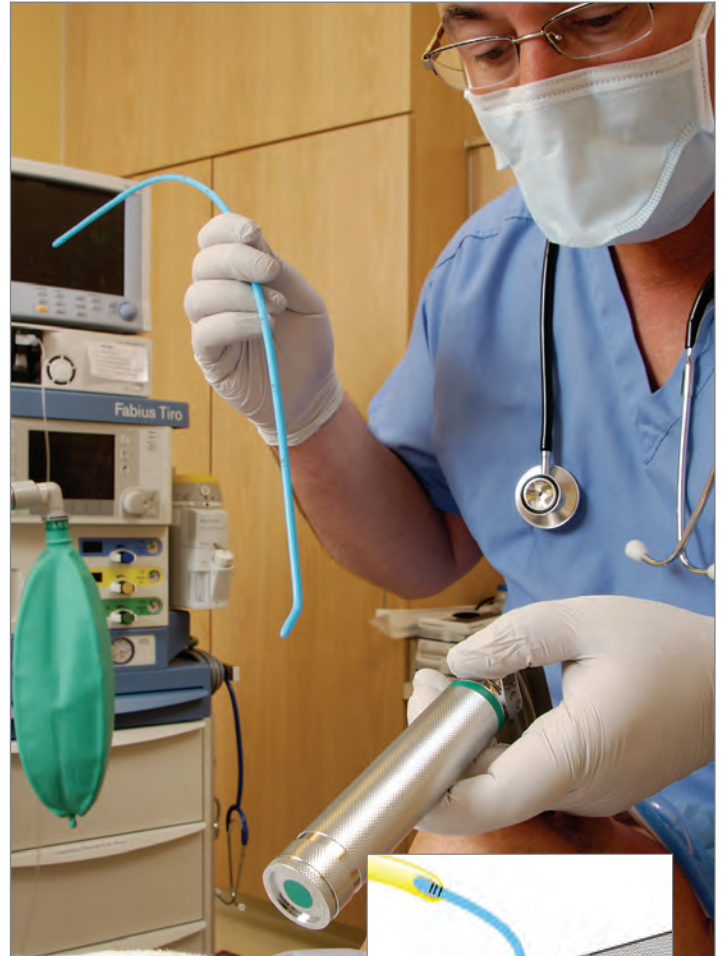

Introducer

MALLEABLE INTRODUCER

STERILE | LATEX FREE | SINGLE USE | DISPOSABLE

SunMed



- Combines benefits of an introducer and stylette into one unit
- Pediatric size features calibrated markings on both ends allowing it to be used as a straight or coudé tip
- Adjustable stop

CAT#	SIZE	DESCRIPTION	PK
9-0213-82	10Fr x 70cm	Pediatric Malleable, Coudé & Straight Tip	10
9-0213-92	15Fr x 70cm	Adult, Malleable, Coudé Tip	10



FOR COMPLETE
Customer Service
Technical Information
Care/Cleaning Instructions
Product Literature

CALL
800-433-2797
VISIT
www.Sun-Med.com

EMAIL
info@Sun-Med.com





The Bougie-To-Go is specially packaged to fit in smaller compartments, bags, and even pockets, making it ideal for first responders

Introducer
BOUGIE-TO-GO

STERILE | LATEX FREE | SINGLE USE | DISPOSABLE



- Innovative compact packaging designed specifically for use by EMS professionals
- Low density polyethylene provides proper stiffness for ease of insertion
- Calibrated to ensure accurate distance insertion
- Fits in 6mm to 11mm tubes

CAT#	SIZE	DESCRIPTION	PK
9-0212-82	15Fr x 60cm	Adult, Coudé Tip	10

Introducer
PORTED INTRODUCER

STERILE | LATEX FREE | SINGLE USE | DISPOSABLE



- Suitable for providing oxygenation during intubation or eliminating light secretions
- Suction and extract tracheal gas samples for analysis
- 70cm x hose barb fitting included
- 15mm Male connector included
- Marked to determine depth
- Coudé tip with two eyes

CAT#	SIZE	DESCRIPTION	PK
9-0212-80	15Fr x 70cm	Adult Ported Introducer	10



Stylette
PVC COATED

STERILE | LATEX FREE | SINGLE USE | DISPOSABLE

SunMed



- Malleable aluminum
- Sealed in a PVC sheath

CAT#	SIZE	DESCRIPTION	PK
9-0203-06	10" x 6Fr	SunSlip™ with Sheath	20
9-0203-10	11.5" x 10Fr	SunSlip™ with Sheath	20
9-0203-14	12.5" x 14Fr	SunSlip™ with Sheath	20

Stylette
COATED

STERILE | LATEX FREE | SINGLE USE | DISPOSABLE

SunMed

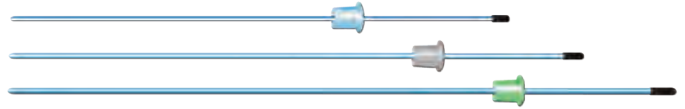

- Color coded adjustable stopper
- Coated surface reduces the need for lubricants

CAT#	SIZE	DESCRIPTION	PK
9-0209-71	13" x 6Fr	SunGlide™ Stylette	25
9-0209-72	15.5" x 8Fr	SunGlide™ Stylette	25
9-0209-73	18" x 10Fr	SunGlide™ Stylette	25

Stylette
FIBER OPTIC

LATEX FREE | REUSABLE

SunMed



- Adjustable stop
- Single use stops available

CAT#	SIZE	DESCRIPTION	PK
9-0204-18	18"	Adult Stylette	1
9-0204-14	14"	Pediatric Stylette	1
5-0240-59	-	Replacement Lamp	1
9-0210-05	-	Replacement Stops	5

Stylette
LIGHTED

LATEX FREE | SINGLE USE | DISPOSABLE

SunMed



- Lighted
- Adjustable stop

CAT#	SIZE	DESCRIPTION	PK
9-0210-01	15.75"	Adult Stylette	1



Stylette

ALUMINUM

LATEX FREE | SINGLE USE | DISPOSABLE

SunMed



- Aluminum
- Malleable

CAT#	SIZE	DESCRIPTION	PK
9-0204-00	16" x 10Fr	Adult Stylette	1
9-0204-10	16" x 10Fr	Adult Stylette	10
9-0204-12	12" x 10Fr	Pediatric Stylette	1
9-0204-22	12" x 10Fr	Pediatric Stylette	10

Stylette

ALUMINUM

STERILE | LATEX FREE | SINGLE USE | DISPOSABLE

SunMed



- Malleable with rounded end
- Satin finish to reduce friction
- Pediatric stylette fits in 2-5mm tubes
- Adult stylette fits in 6-11mm tubes

CAT#	SIZE	DESCRIPTION	PK
9-0204-11	11" x 6Fr	Pediatric Stylette	25
9-0204-25	16" x 9Fr	Adult Stylette	25

Stylette

STAINLESS STEEL

LATEX FREE | REUSABLE

SunMed



- Surgical stainless steel
- Malleable

CAT#	SIZE	DESCRIPTION	PK
9-0207-03	16.5" x 6Fr	Adult Stylette	1
9-0207-01	11.5" x 6Fr	Pediatric Stylette	1

Stylette

COPPER

LATEX FREE | SINGLE USE | DISPOSABLE

SunMed



- Solid copper version is malleable with adjustable stop
- Hollow copper tube features suction port

CAT#	SIZE	DESCRIPTION	PK
9-0203-00	14.75" x 8Fr	Solid Copper Stylette	1
9-0206-01	16.5"	Hallow Copper Stylette	1



RESUSCITATION / VENTILATION



26-33 Resuscitators / Ventilators

34-35 Hyperinflation

37-39 Breathing Filters

41 Circuits

SunMed

Ventlab

Ethox

Manual Resuscitator / Ventilator

AIRFLOW

LATEX FREE | SINGLE PATIENT USE | DISPOSABLE

Ventlab

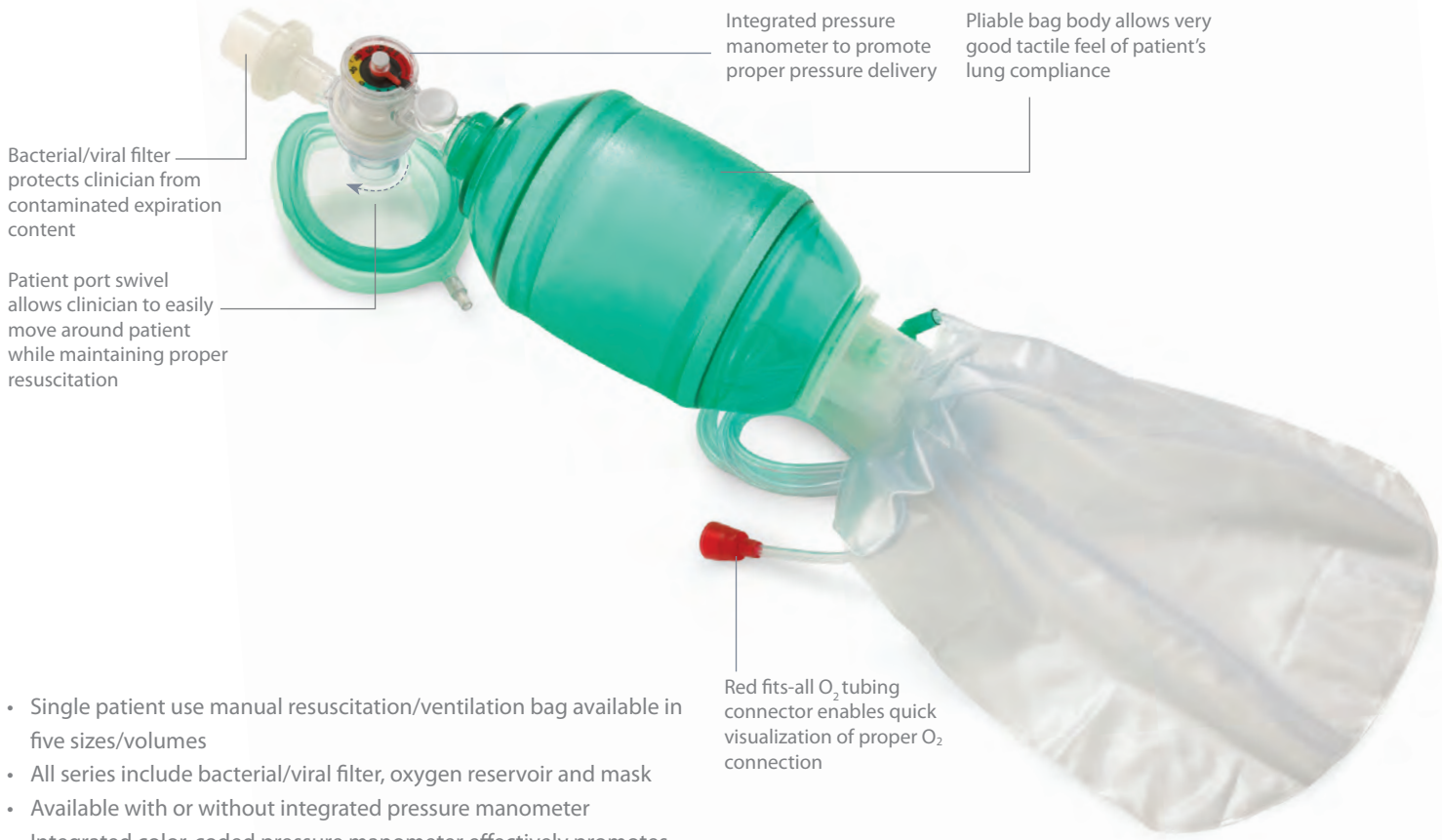

Bacterial/viral filter protects clinician from contaminated expiration content

Patient port swivel allows clinician to easily move around patient while maintaining proper resuscitation

Integrated pressure manometer to promote proper pressure delivery

Pliable bag body allows very good tactile feel of patient's lung compliance

Red fits-all O₂ tubing connector enables quick visualization of proper O₂ connection

- Single patient use manual resuscitation/ventilation bag available in five sizes/volumes
- All series include bacterial/viral filter, oxygen reservoir and mask
- Available with or without integrated pressure manometer
- Integrated color-coded pressure manometer effectively promotes proper pressure delivery (<20cmH₂O); the tri-color fields alert to the risk level of delivered pressure
- Accurate pressure delivery helps reduce gastric insufflation, thus preventing vomiting, aspiration and resulting pneumonia
- Face mask proportionately sized to resuscitation bag size
- Select from a variety of components to assemble a custom resuscitation bag to meet your unique patient needs

Adult AirFlow AF1140-Series Shown with B/V filter, integrated pressure manometer and inflatable adult mask

AIRFLOW + INTEGRATED PRESSURE MANOMETER

CAT#	SIZE	VOLUME	STROKE VOLUME	PK
AF2140MB	Pediatric	1000ml	650-670ml	10
AF3140MB	Infant	300ml	150-170ml	10
AF4140MB	Child	550ml	320-340ml	10
AF5140MB	Adult	1500ml	640-660ml	10
AF1140MB	Adult	1900ml	950-960ml	10

AIRFLOW STANDARD (WITHOUT PRESSURE MANOMETER)

CAT#	SIZE	VOLUME	STROKE VOLUME	PK
AF2040MB	Pediatric	1000ml	650-670ml	10
AF3040MB	Infant	300ml	150-170ml	10
AF4040MB	Child	550ml	320-340ml	10
AF5040MB	Adult	1500ml	640-660ml	10
AF1040MB	Adult	1900ml	950-960ml	10



CUSTOMIZE YOUR RESUSCITATION / VENTILATION BAG

Choose from the following components to create a custom resuscitation/ventilation bag to best meet your needs:

OXYGEN RESERVOIRS



INFLATABLE O₂ BAG

Closed system oxygen reservoir delivers higher FDO₂ and provides visual indication of proper airflow



CORRUGATED TUBING

For use with secondary oxygen supply; available in 24" and 48" lengths



COLLAPSIBLE/EXTENDABLE O₂ ACCUMULATOR

Available only for AF1000 series

CONVENIENCE COMPONENTS



FACE MASKS

Inflatable and non-inflatable face masks available



FLEX NECK

Removable, flexible joint allows corrugated tubing to be joined with the patient valve; also reduces the torque on ET tube



HAND STRAP

Maintain a positive grip with a hand strap



AirFlow bags come standard with an inflatable mask on Adult bag sizes. All other size bags come with non-inflatable masks.

Infant AirFlow AF3140-Series

SAFETY COMPONENTS



INTEGRATED PRESSURE MANOMETER

Ventlab's innovative color-coded dial clearly denotes pressure delivery:

Green - Target pressure level <20cmH₂O

Yellow - Potentially dangerous pressure level

Red - Dangerous pressure level



POP-OFF VALVES

40cm/H₂O & 25cm/H₂O

Allows clinician to use an appropriate pop-off level



FILTERS

A bacterial/viral filter provides effective protection for the healthcare provider during expiration



CO₂ INDICATOR

The STAT-Check II is an effective assessment tool for verifying CO₂ exchange



PEEP VALVES

Adjustable PEEP valves; 5-20cm/H₂O



Manual Resuscitator / Ventilator

V-CARE

LATEX FREE | SINGLE PATIENT USE | DISPOSABLE

Ventlab

Patient port swivel allows clinician to easily move around patient while maintaining proper resuscitation

Ultra soft pliable silicone bag body provides excellent tactile feel of lung compliance



Integrated pressure manometer to promote proper pressure delivery

Pop-off valve allows clinician to use an appropriate pop-off level

Child V-Care
VN4100-Series

Shown with integrated pressure manometer, pop-off valve, size 4 mask, and inflatable O₂ reservoir

Red fits-all O₂ tubing connector enables quick visualization of proper O₂ connection

- Single patient use manual resuscitation/ventilation bag available in four sizes/volumes
- Ultra soft silicone bag body with a quick rebound capacity provides optimum tactile sensitivity to accurately assess lung compliance
- Available with or without integrated pressure manometer
- Integrated color-coded pressure manometer effectively promotes proper pressure delivery (<20cmH₂O); the tri-color fields alert to the risk level of delivered pressure
- Accurate pressure delivery helps reduce gastric insufflation, thus preventing vomiting, aspiration and resulting pneumonia
- Includes Premium Inflatable Vent Mask, proportionately sized to resuscitation bag size
- Select from a variety of components to assemble a custom resuscitation bag to meet your unique patient needs

V-CARE + INTEGRATED PRESSURE MANOMETER

CAT#	SIZE	VOLUME	STROKE VOLUME	PK
VN2100MB	Pediatric	1000ml	600-630ml	10
VN3100MB	Infant	300ml	150-170ml	10
VN4100MB	Child	550ml	330-340ml	10
VN5000MB	Adult	1500ml	640-660ml	10

V-CARE STANDARD (WITHOUT PRESSURE MANOMETER)

CAT#	SIZE	VOLUME	STROKE VOLUME	PK
VN2000MB	Pediatric	1000ml	600-630ml	10
VN3000MB	Infant	300ml	150-170ml	10
VN4000MB	Child	550ml	330-340ml	10



CUSTOMIZE YOUR RESUSCITATION / VENTILATION BAG

Choose from the following components to create a custom resuscitation/ventilation bag to best meet your needs:



Silicone bags come standard with an inflatable Premium Vent Mask

Pediatric V-Care VN2100-Series

Shown with integrated pressure manometer, pop-off valve and corrugated tubing

OXYGEN RESERVOIRS



INFLATABLE O₂ BAG

Closed system oxygen reservoir delivers higher FDO₂ and provides visual indication of proper airflow



CORRUGATED TUBING

For use with secondary oxygen supply; available in 24" and 48" lengths



COLLAPSIBLE/EXTENDABLE O₂ ACCUMULATOR

Available only for AF1000 series

CONVENIENCE COMPONENTS



FACE MASKS

Inflatable and non-inflatable face masks available



FLEX NECK

Removable, flexible joint allows corrugated tubing to be joined with the patient valve; also reduces the torque on ET tube

SAFETY COMPONENTS



INTEGRATED PRESSURE MANOMETER

Ventlab's innovative color-coded dial clearly denotes pressure delivery:

Green - Target pressure level <20cmH₂O

Yellow - Potentially dangerous pressure level

Red - Dangerous pressure level



POP-OFF VALVES

40cm/H₂O & 25cm/H₂O
Allows clinician to use an appropriate pop-off level



FILTERS

A bacterial/viral filter provides effective protection for the healthcare provider during expiration



CO₂ INDICATOR

The STAT-Check II is an effective assessment tool for verifying CO₂ exchange



PEEP VALVES

Adjustable PEEP valves; 5-20cm/H₂O



Manual Resuscitator / Ventilator

SAFE SPOT

LATEX FREE | SINGLE PATIENT USE | DISPOSABLE

Ventlab

Patient port swivel allows clinician to easily move around patient while maintaining proper resuscitation

Pliable silicone bag body with indented, thin-walled 'safe spots' effectively enhance tactile feel of lung compliance

Integrated pressure manometer to promote proper pressure delivery

Pop-off valve allows clinician to use an appropriate pop-off level

Red Fits-All O₂ tubing connector enables quick visualization of proper O₂ connection

- Single patient use manual resuscitation/ventilation system designed specifically for infant patients
- Bag features ultra-thin 'spots' to provide an enhanced tactile feel for lung compliance and increased patient safety
- Integrated pressure manometer promotes proper delivery (<20cmH₂O) to guard against over-pressurization of babies' fragile lungs; the tri-color fields alert to the risk level of delivered pressure
- Accurate pressure delivery helps reduce barotrauma or pneumothoraces
- Pop-off valve (40cm/H₂O and 25cm/H₂O available) enables clinicians to use the pop off level appropriate for a given patient population creating a greater margin of safety for the baby
- Optional Vent Mask in various sizes available
- Select from a variety of components to assemble a custom resuscitation bag to meet your unique patient needs

Safe Spot
SS3200-Series

Shown with integrated pressure manometer, pop-off valve, and inflatable O₂ reservoir

CAT#	SIZE	VOLUME	STROKE VOLUME	PK
SS3200MB	Infant	250ml	140-170ml	10



CUSTOMIZE YOUR RESUSCITATION / VENTILATION BAG

Choose from the following components to create a custom resuscitation/ventilation bag to best meet your needs:



Safe Spot bags come standard with an inflatable Vent Mask

Safe Spot SS3200-Series

Shown with integrated pressure manometer, pop-off valve, and corrugated tubing

OXYGEN RESERVOIRS



INFLATABLE O₂ BAG

Closed system oxygen reservoir delivers higher FDO₂ and provides visual indication of proper airflow



CORRUGATED TUBING

For use with secondary oxygen supply; available in 24" and 48" lengths

CONVENIENCE COMPONENTS



FACE MASKS

Inflatable and non-inflatable face masks available

SAFETY COMPONENTS



INTEGRATED PRESSURE MANOMETER

Ventlab's innovative color-coded dial clearly denotes pressure delivery:

Green - Target pressure level <20cmH₂O

Yellow - Potentially dangerous pressure level

Red - Dangerous pressure level



POP-OFF VALVES

40cm/H₂O & 25cm/H₂O
Allows clinician to use an appropriate pop-off level



FILTERS

A bacterial/viral filter provides effective protection for the healthcare provider during expiration



CO₂ INDICATOR

The STAT-Check II is an effective assessment tool for verifying CO₂ exchange



PEEP VALVES

Adjustable PEEP valves; 5-20cm/H₂O

Manual Resuscitator / Ventilator

STAT CHECK II

LATEX FREE | SINGLE PATIENT USE | DISPOSABLE

Ventlab

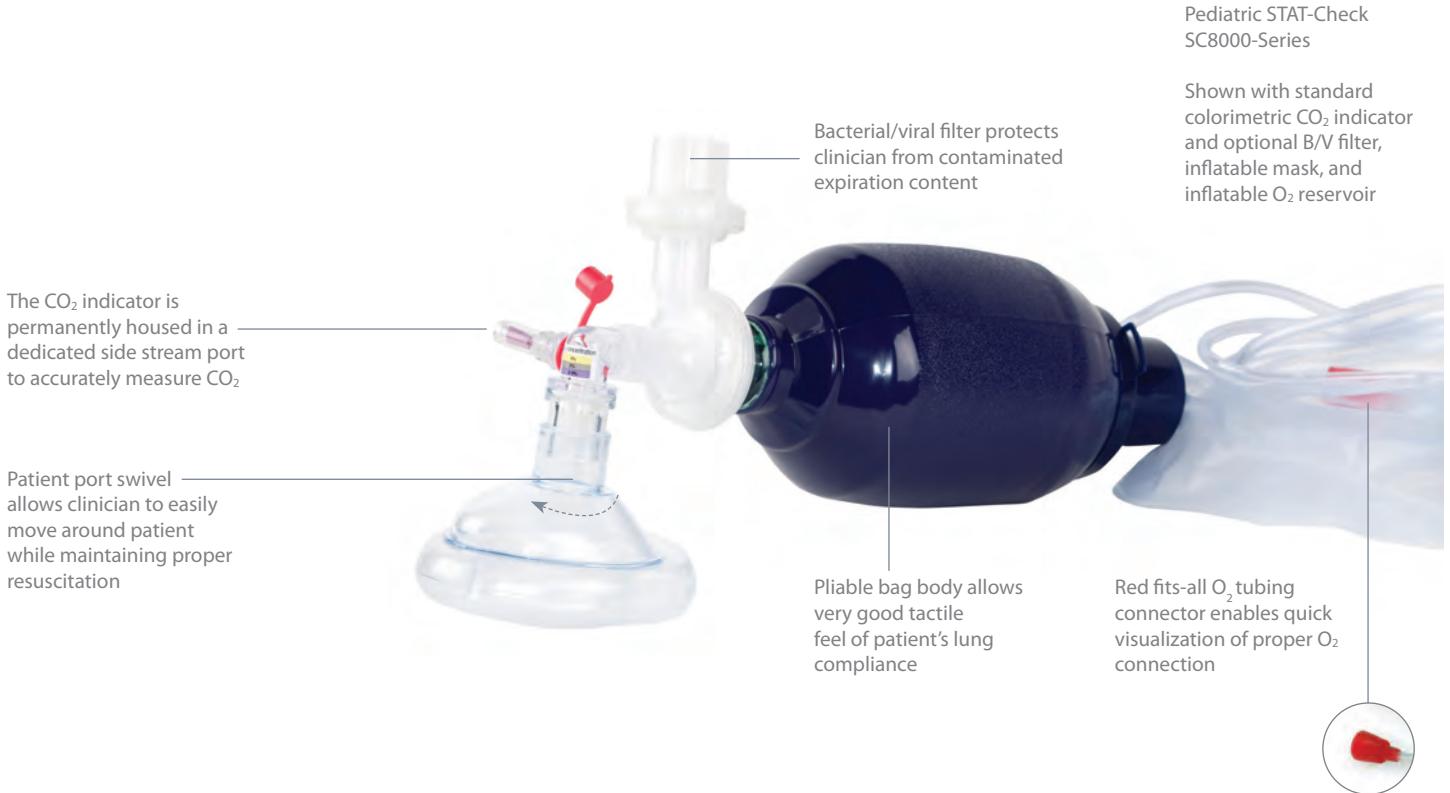

Pediatric STAT-Check
SC8000-Series

Shown with standard
colorimetric CO₂ indicator
and optional B/V filter,
inflatable mask, and
inflatable O₂ reservoir

The CO₂ indicator is permanently housed in a dedicated side stream port to accurately measure CO₂

Patient port swivel allows clinician to easily move around patient while maintaining proper resuscitation

Bacterial/viral filter protects clinician from contaminated expiration content

Pliable bag body allows very good tactile feel of patient's lung compliance

Red fits-all O₂ tubing connector enables quick visualization of proper O₂ connection

- Single patient use manual resuscitation/ventilation bag available in four sizes
- Effectively verifies CO₂ exchange with easy-to-read colorimetric CO₂ indicator
- CO₂ indicator is permanently housed in a dedicated port; no need to install prior to use
- Available with or without integrated pressure manometer
- Integrated color-coded pressure manometer effectively promotes proper pressure delivery (<20 cmH₂O); the tri-color fields alert to the risk level of delivered pressure
- Proper pressure delivery helps reduce gastric insufflation, thus preventing vomiting, aspiration and resulting pneumonias
- Face mask proportionately sized to resuscitation bag size
- Select from a variety of components to assemble a custom resuscitation bag to meet your unique patient needs

STAT-CHECK + INTEGRATED PRESSURE MANOMETER

CAT#	SIZE	VOLUME	STROKE VOLUME	PK
SC7101	Infant	300ml	140-170ml	10
SC6101	Child	550ml	320-340ml	10
SC8101	Pediatric	1000ml	650-670ml	10
SC9101	Adult	1900ml	950-960ml	10

STAT-CHECK STANDARD (WITHOUT PRESSURE MANOMETER)

CAT#	SIZE	VOLUME	STROKE VOLUME	PK
SC7000	Infant	300ml	140-170ml	10
SC6000	Child	550ml	320-340ml	10
SC8000	Pediatric	1000ml	650-670ml	10
SC9000	Adult	1900ml	950-960ml	10



CUSTOMIZE YOUR RESUSCITATION / VENTILATION BAG

Choose from the following components to create a custom resuscitation/ventilation bag to best meet your needs:

OXYGEN RESERVOIRS



INFLATABLE O₂ BAG
Closed system oxygen reservoir delivers higher FDO₂ and provides visual indication of proper airflow



CORRUGATED TUBING
For use with secondary oxygen supply; available in 24" and 48" lengths

CONVENIENCE COMPONENTS



FACE MASKS
Inflatable and non-inflatable face masks available



FLEX NECK
Removable, flexible joint allows corrugated tubing to be joined with the patient valve; also reduces the torque on ET tube

CO₂ Indicator STAT CHECK

LATEX FREE

Ventlab



- Verifies CO₂ exchange during resuscitation
- Helps confirm proper ET tube placement
- Three color scale enables clear visualization of CO₂ exchange
- A simple twist removes the cap and immediately activates CO₂ detection

SAFETY COMPONENTS



INTEGRATED PRESSURE MANOMETER
Ventlab's innovative color-coded dial clearly denotes pressure delivery:

Green - Target pressure level <20cmH₂O
Yellow - Potentially dangerous pressure level
Red - Dangerous pressure level



POP-OFF VALVES
40cm/H₂O & 25cm/H₂O
Allows clinician to use an appropriate pop-off level





FILTERS
A bacterial/viral filter provides effective protection for the healthcare provider during expiration



PEEP VALVES
Adjustable PEEP valves; 5-20cm/H₂O



Easy-to-read colorimetric CO₂ indicator reads purple to yellow when exposed to CO₂

Color indication of CO₂ Presence
0% CO₂ PRESENT  5% CO₂ PRESENT 
----->
Active Resuscitation / Ventilation

CAT#	DESCRIPTION	PK
SC200	STAT-Check CO ₂ Indicator	10

Hyperinflation

HYPERINFLATION SYSTEM

LATEX FREE | SINGLE PATIENT USE | DISPOSABLE

Ventlab



Integrated pressure manometer to promote proper pressure delivery

Patient port swivel allows clinician to easily move around patient while maintaining proper resuscitation



Comes standard with stay-put dial to enable clinician to achieve targeted static pressure

- Available with or without integrated pressure manometer
- Integrated color-coded pressure manometer effectively promotes proper pressure delivery (<20cm H₂O); the tri-color fields alert to the risk level of delivered pressure
- Proper pressure delivery helps reduce gastric insufflation, thus preventing vomiting, aspiration and resulting pneumonias
- Systems equipped with a stay-put dial to enable clinician to achieve targeted static pressure
- Five pleated breathing bag sizes available: 1/4, 1/2, 1, 2, and 3 liter
- Seven inflatable face mask sizes available: Small infant, infant, small child, child, and adult (regular, large, wide)
- Non-inflatable face masks can be specified
- Select from a variety of components to assemble a custom resuscitation bag to meet your unique patient needs

Pleated breathing bags in 5 sizes:



CAT#	SIZE	PK
HS1000	Hyperinflation System	20
HS4000	Hyperinflation System + Integrated Manometer	20



CUSTOMIZE YOUR HYPERINFLATION SYSTEM

Choose from the following components to create a custom hyperinflation system to best meet your needs:

SAFETY COMPONENTS



INTEGRATED PRESSURE MANOMETER

Ventlab's innovative color-coded dial clearly denotes pressure delivery:

- Green** - Target pressure level <math><20\text{cmH}_2\text{O}</math>
- Yellow** - Potentially dangerous pressure level
- Red** - Dangerous pressure level



POP-OFF VALVES

40cm/H₂O & 25cm/H₂O

Allows clinician to use an appropriate pop-off level

CONVENIENCE COMPONENTS



COLLAPSIBLE / EXTENDABLE O₂ ACCUMULATOR



FACE MASKS

Inflatable and non-inflatable face masks available

Hyperinflation 4000 series
Shown with integrated pressure
manometer and 40cm pop-off valve



Manual Resuscitator / Ventilator

MANUAL RESUSCITATION TRAINING KIT

LATEX FREE

Ventlab

Manual Resuscitation Training Kits are designed to illustrate the effect excessive delivered pressure has on a patient during resuscitation. Pressures >20cm H₂O open the esophageal sphincter, forcing air into the stomach creating distention and gastric insufflation leading to aspiration and associated pneumonia. Clinicians and students can benefit from using Manual Resuscitation Training Kits to learn about pressure delivery, while increasing their confidence performing manual resuscitation using Ventlab resuscitators.



VT1000 Adult Manual Resuscitation Training Kit*



VT2000 Infant Manual Resuscitation Training Kit*

- Valuable tool for training and demonstration of manual resuscitation procedure
- Choose from adult or infant kits
- Features integrated pressure manometer that effectively promotes proper pressure delivery (<20 cmH₂O); the tri-color fields alert to the risk level of delivered pressure
- Proper pressure delivery helps reduce gastric insufflation, thus preventing vomiting, aspiration and resulting pneumonias
- Clear, visual instructions provided
- Resource materials help clarify the benefits of the integrated pressure manometer
- Includes durable zippered canvas duffel bag

CAT#	DESCRIPTION	PK
VT1000	Adult Resuscitation Training Kit*	1
VT2000	Infant Resuscitation Training Kit*	1

**Manual Resuscitation Training Kits and individual components are NOT intended for patient use; it is strictly a demonstration device and practice tool.*



Breathing Filter

BACTERIAL / VIRAL FILTER

LATEX FREE | SINGLE PATIENT USE | DISPOSABLE

Ventlab

- Help reduce the transmission of microbes and other particulate matter in the breathing system
- Filters up to 99.99% of expiratory bacterial/viral content
- Designed to reduce drag on the breathing system while ensuring patient comfort
- Available in a variety of sizes and shapes
- Compatible with leading breathing systems
- Bulk packaged (50 EA)

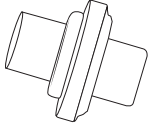
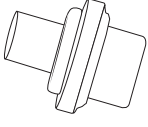
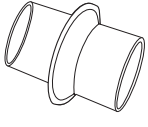
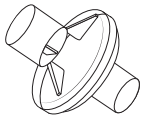
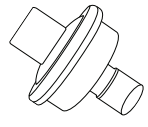

BACTERIAL / VIRAL FILTER					
CAT#	BF101	BF102	BF103	FH603003	FH603026
DESCRIPTION	Accepts 19mm	Accepts 19mm or 30mm	Accepts 19mm or 30mm	Vt Range >250ml	Tidal Volume >150ml
B/V EFFICIENCY	>99.99%	>99.99%	>99.99%	>99.99%	>99.99%
WEIGHT (G)	9.6	11.8	12.4	25.0/25.7	40.6
ID / OD (MM)	19ID x 19ID	19ID x 22ID / 30 OD	30ID x 22ID / 30OD	22ID x 15ID / 22OD	22ID x 15ID / 22OD
DEAD SPACE (ML)	16	20	29	54	54
RESISTANCE (CMH ₂ O) 30LPM	<1.8	<2.2	<2	<1 (<2 @60LPM)	<1.4
SAMPLING PORT	No	No	No	No/Yes	Yes

Filter Accessory

FLEX TUBING FOR B/V FILTERS

LATEX FREE | SINGLE PATIENT USE | DISPOSABLE

Ventlab

- For use with bacterial/viral filters
- Standard 6" 15mm flex tubing
- Bulk packaged

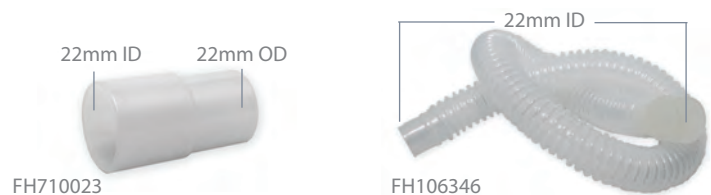

CAT#	DESCRIPTION	PK
FH710023	Cuff / 22mm ID x 22mm OD	50
FH106346	Adapter / 22mm ID x 22mm ID + 22mm 24" Corrugated Tubing	50



Humidification





HYDROSCOPIC CONDENSER HUMIDIFIER (HCH, HME)

LATEX FREE | SINGLE PATIENT USE | DISPOSABLE

Ventlab

- Effectively provides heat and moisture delivery/recovery for ventilated and spontaneously breathing patients
- Designed with sampling port (unless indicated)
- Available in a variety of sizes and shapes
- Compatible with leading breathing systems
- Bulk packaged (50 EA)

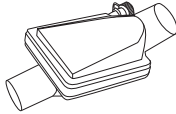

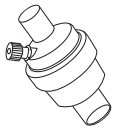
HYDROSCOPIC CONDENSER HUMIDIFIER					
CAT#	FH603007 (no port FH603006)	FH603010	FH603012	FH603014 (no port FH603024)	FH603021 (no port FH603023)
DESCRIPTION	Round	Swivel	Rectangular	Small Angle	Small Straight
VT RANGE (ML)	250 - 1500	250 - 1500	200 - 1500	150 - 100	150 - 1000
MOISTURE OUTPUT (MGH ₂ O/L) ±0.1G	33	34	32	31	31.5
WEIGHT (G)	36.4/27.8	31.8	28.1	24.7	22.3
ID / OD (MM)	22ID x 22OD/15ID	22ID x 22OD/15ID	15ID x 22OD/15ID	15ID x 22OD/15ID	22ID x 22OD/15ID
DEAD SPACE (ML)	90	74	62	36	32
RESISTANCE (CMH ₂ O) 8LPM	<1	<1	<1	<1	<1
RESISTANCE (CMH ₂ O) 30LPM	<1	<1	<1	<1	<1

Breathing Filter

HEPA FILTER

LATEX FREE | SINGLE PATIENT USE | DISPOSABLE

Ventlab

- >150ml Tidal volume
- 99.99% Filtering efficiency
- 54ml Dead space



Humidification

BUBBLE HUMIDIFIER

LATEX FREE | SINGLE USE | DISPOSABLE

Ventlab

- 6-15LPM
- Features 6 PSI (414 mbar) pressure relief valve



CAT#	DESCRIPTION	SIZE	PK
FH603026	HEPA Filter	22ID x 15ID x 22OD	50

CAT#	DESCRIPTION	PK
6900	Bubble Humidifier	10



Humidification & Filtration



HYDROSCOPIC CONDENSER HUMIDIFIER + FILTER (HCHF, HMEF)

LATEX FREE | SINGLE PATIENT USE | DISPOSABLE

Ventlab

- Filters up to 99.99% of expiratory bacterial/viral content
- Effectively provides heat and moisture delivery/recovery for ventilated and spontaneously breathing patients
- Designed with sampling port (unless indicated)
- Available in a variety of sizes and shapes
- Compatible with leading breathing systems
- Bulk packaged (50 EA)

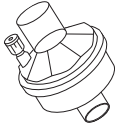

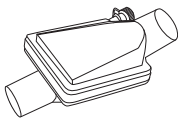
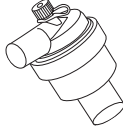
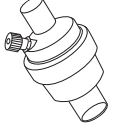
HYDROSCOPIC CONDENSER HUMIDIFIER WITH FILTER					
CAT#	FH603008 (no port FH603005)	FH603009	FH603011	FH603013 (no port FH603025)	FH603020 (no port FH603022)
DESCRIPTION	Round	Swivel	Rectangular	Small Angle	Small Straight
VT RANGE (ml)	250 - 1500	250 - 1500	200 - 1500	150 - 100	150 - 1000
MOISTURE OUTPUT (MGH ₂ O/L) ±0.1G	33	36	32.5	31.5	31
WEIGHT (G)	37.2/31.3	34.6	26.6	23.6	22.8
ID / OD (MM)	22ID x 22OD/15ID	22ID x 22OD/15ID	22ID x 22OD/15ID	15ID x 22OD/15ID	15ID x 22OD/15ID
DEAD SPACE (ML)	90	74	62	36	32
RESISTANCE (CMH ₂ O) 8LPM	<1	<1	<1	<1	<1
RESISTANCE (CMH ₂ O) 30LPM	<1	<2	<1	<3	<2
B/V EFFICIENCY	>99.99%	>99.99%	>99.99%	>99.99%	>99.99%

Filter Accessory

FLEX TUBING FOR HME/HMEF

LATEX FREE | SINGLE PATIENT USE | DISPOSABLE

Ventlab

- For use with hygroscopic condenser humidifiers
- Standard 6", 15mm flex tubing

CAT#	DESCRIPTION	FLEX TUBE	PK
FH106347	15mm OD x 15mm OD	6" x 15mm ID	50
FH106348	15mm OD x 22mm OD/15mm ID	6" x 15mm ID	50
FH106380	15mm OD x 22mmOD/15mm ID 15mm OD connector	6" x 15mm ID	50

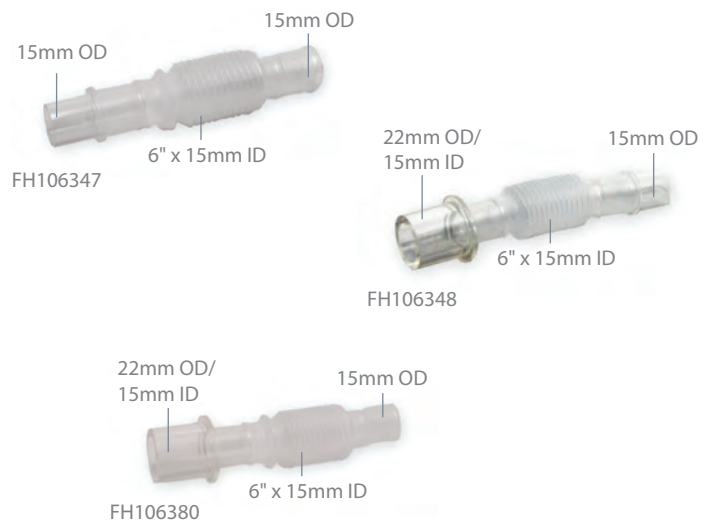

Cannula + Circuit Organizer

TUBE TREE

LATEX FREE

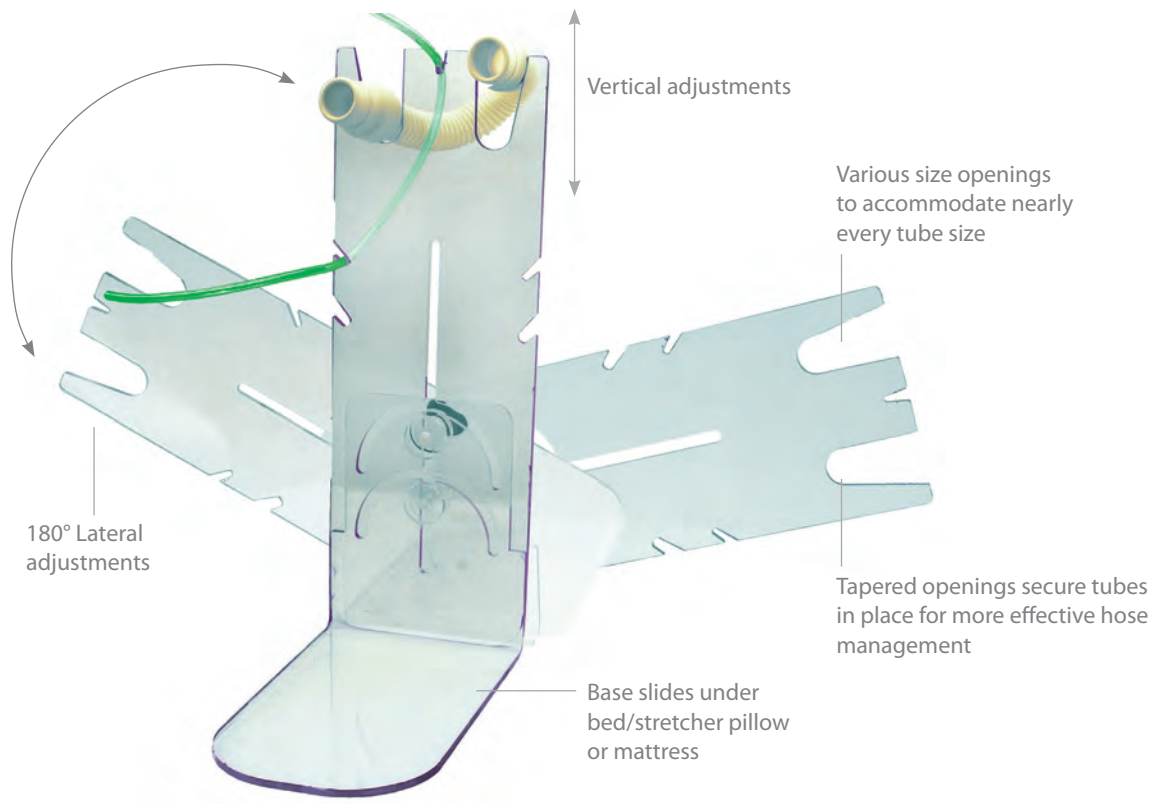

8-0038-04

- Easily restrain oxygen and suction tubing, gas sampling lines
- Effectively manage all three diameter breathing hoses: small disposable plastic, medium reusable rubber and plastic, large king hoses
- Available in stainless steel or clear polycarbonate (PC) for long life
- PC models are more durable than acrylic and can be safely cleaned with alcohol
- PC models accommodate gas sampling tubes
- PC models safe for MRI use
- Each model measures 12.125"H x 5"W x 8.5"D

CAT#	DESCRIPTION	PK
8-0038-01	Stainless Steel Tube Tree	1
8-0038-03	Polycarbonate Tube Tree	1
8-0038-04	Adjustable Polycarbonate Tube Tree	1



8-0038-01



8-0038-03



Breathing Circuit
MRI CIRCUIT

LATEX FREE | SINGLE PATIENT USE | DISPOSABLE

Ventlab

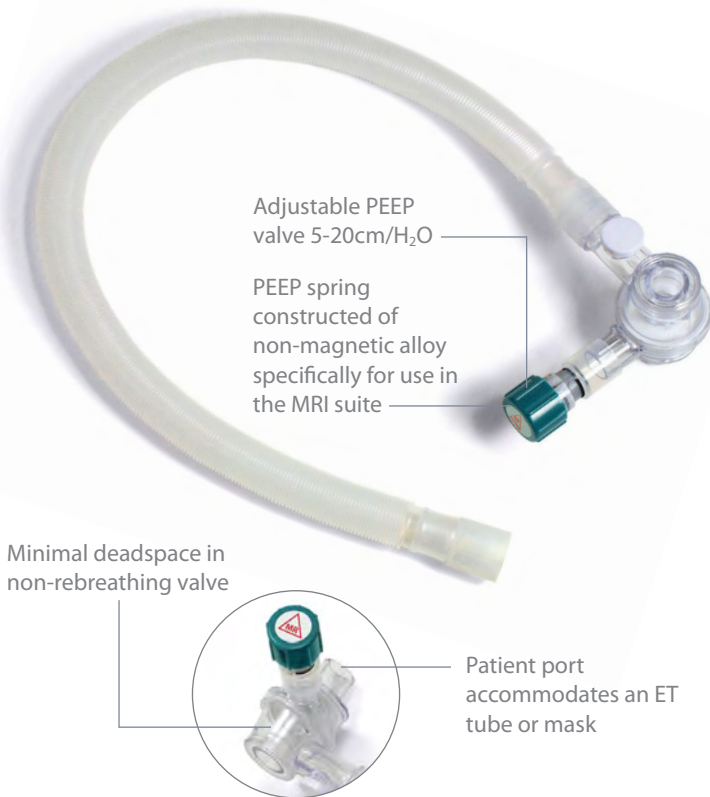

- Patient valve, PEEP valve and oxygen tubing constructed of MRI-safe materials
- 3 o'clock position of PEEP keeps valve out of patient's face
- For use with Smiths Medical Pneupac and other ventilators
(Consult ventilator manufacturer specifications prior to use)
- Corrugating tubing expands generously to 9' for easier ventilation management during procedures
- Circuit available with or without PEEP valve



CAT#	DESCRIPTION	PK
VC1000	MRI Transport Circuit + PEEP Valve	10
VC1000F	MRI Transport Circuit + PEEP Valve + Filter	10
VC1010	MRI Transport Circuit	10
VC1010F	MRI Transport Circuit + Filter	10
VP705	MRI 19mm Adjustable PEEP Valve	20

Breathing Circuit
STANDARD CIRCUIT

LATEX FREE | SINGLE PATIENT USE | DISPOSABLE

Ventlab



- Use as a conduit for gases between a Respirationics® positive pressure generator and a patient during non-invasive ventilation
- 72" smooth bore tubing with pressure monitoring line and dual ported adapter
- 24" extension tubing with T-assembly for dual pressure monitoring

CAT#	DESCRIPTION	PK
RC1000	Standard Circuit + 22mm OD Adapter	10



ANESTHESIA



- 44-69 Fiber Optic Laryngoscopes
- 70-89 Conventional Laryngoscopes
- 91-93 Masks
- 94-96 Pressure Infusion
- 97-99 Accessories

SunMed

Ventlab

Ethox



GO GREEN with Single Patient Use Fiber Optic Laryngoscope Blades & Handles

GreenLine®/D™ Fiber Optic Laryngoscope
MACINTOSH

LATEX FREE | STERILE | SINGLE PATIENT USE | DISPOSABLE

SunMed



- Disposable blade solves contamination problems and eliminate the cost and time spent cleaning blades and returning them for use
- Answers the professional's request for a non-plastic single-use blade suitable for everyday hospital use
- Polished acrylic stem produces exceptional illumination
- Compliant with ISO standard 7376
- Green System compatible
- Constructed of surgical stainless steel

CAT#	SIZE	DESCRIPTION	A	B	PK
5-5332-01	1	Infant	92mm	22mm	20
5-5332-02	2	Child	100mm	21mm	20
5-5332-03	3	Medium Adult	130mm	22mm	20
5-5332-35	3.5	Ext. Med. Adult	144mm	22mm	20
5-5332-04	4	Large Adult	155mm	25mm	20

GreenLine®/D™ Fiber Optic Laryngoscope
MILLER

LATEX FREE | STERILE | SINGLE PATIENT USE | DISPOSABLE

SunMed



- Disposable blade solves contamination problems and eliminate the cost and time spent cleaning blades and returning them for use
- Answers the professional's request for a non-plastic single-use blade suitable for everyday hospital use
- Polished acrylic stem produces exceptional illumination
- Compliant with ISO standard 7376
- Green System compatible
- Constructed of surgical stainless steel

CAT#	SIZE	DESCRIPTION	A	B	PK
5-5333-20	00	Premature	67mm	10mm	20
5-5333-00	0	Newborn	77mm	10mm	20
5-5333-01	1	Infant	102mm	10mm	20
5-5333-02	2	Child	153mm	12mm	20
5-5333-03	3	Medium Adult	195mm	14mm	20
5-5333-04	4	Large Adult	205mm	18mm	20



One time. One choice. One solution.

GreenLine®/D™ Fiber Optic Laryngoscope
ROBERTSHAW

LATEX FREE | STERILE | SINGLE PATIENT USE | DISPOSABLE

SunMed



- Disposable blade solves contamination problems and eliminate the cost and time spent cleaning blades and returning them for use
- Answers the professional's request for a non-plastic single-use blade suitable for everyday hospital use
- Polished acrylic stem produces exceptional illumination
- Compliant with ISO standard 7376
- Green System compatible
- Constructed of surgical stainless steel

CAT#	SIZE	DESCRIPTION	A	B	PK
5-5337-00	0	Newborn	94mm	11mm	20
5-5337-01	1	Infant	112mm	13mm	20

GreenLine®/D™ Fiber Optic Laryngoscope
FLEX TIP

LATEX FREE | STERILE | SINGLE PATIENT USE | DISPOSABLE

SunMed



- Disposable blade solves contamination problems and eliminate the cost and time spent cleaning blades and returning them for use
- Answers the professional's request for a non-plastic single-use blade suitable for everyday hospital use
- Polished acrylic stem produces exceptional illumination
- Compliant with ISO standard 7376
- Green System compatible
- Constructed of surgical stainless steel

CAT#	SIZE	DESCRIPTION	A	B	PK
5-5382-03	3	Medium Adult	195mm	18mm	10
5-5382-04	4	Large Adult	205mm	18mm	10

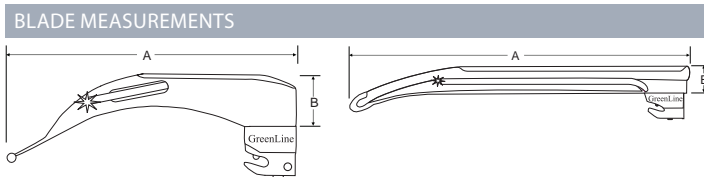

GreenLine®/D™ Fiber Optic Laryngoscope
ALL-METAL MACINTOSH

LATEX FREE | STERILE | SINGLE PATIENT USE | DISPOSABLE

SunMed



- Flexible fiber optic bundle protected in black plastic sheath
- Designed with three ball bearings in the heel for secure handle attachment
- Macintosh blades feature beaded tip reduces tissue trauma
- Constructed of surgical grade 303/304 stainless steel

CAT#	SIZE	DESCRIPTION	A	B	PK
5-5335-01	1	Infant	92mm	22mm	20
5-5335-02	2	Child	100mm	21mm	20
5-5335-03	3	Medium Adult	130mm	22mm	20
5-5335-04	4	Large Adult	155mm	25mm	20

GreenLine®/D™ Fiber Optic Laryngoscope
ALL-METAL MILLER

LATEX FREE | STERILE | SINGLE PATIENT USE | DISPOSABLE

SunMed



- Flexible fiber optic bundle protected in black plastic sheath
- Designed with three ball bearings in the heel for secure handle attachment
- Constructed of surgical grade 303/304 stainless steel

CAT#	SIZE	DESCRIPTION	A	B	PK
5-5336-20	00	Premature	67mm	10mm	20
5-5336-00	0	Neonate	77mm	10mm	20
5-5336-01	1	Infant	92mm	10mm	20
5-5336-02	2	Child	100mm	12mm	20
5-5336-03	3	Medium Adult	130mm	14mm	20
5-5336-04	4	Large Adult	155mm	18mm	20

BLADE MEASUREMENTS

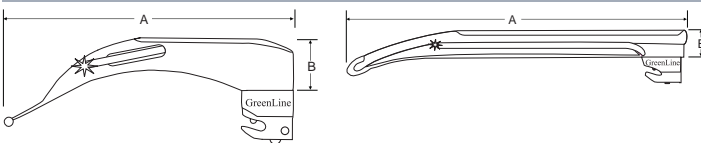

One time. One choice. One solution.

GreenLine®/D™ Fiber Optic Laryngoscope HANDLE

LATEX FREE | SINGLE PATIENT USE | DISPOSABLE

SunMed



- One complete, fully-contained unit
- For use with all GreenLine® laryngoscope blades
- LED illumination provides exceptional, clear viewing
- Complies with ISO 7376 Standard
- Non-sterile; packaged clean
- Mercury-free batteries pre-installed

CAT#	SIZE	DESCRIPTION	PK
5-0236-69	Large	Ribbed Grip Disp. Handle	20

GreenLine®/D™ Fiber Optic Laryngoscope PENLITE HANDLE

LATEX FREE | SINGLE PATIENT USE | DISPOSABLE

SunMed

- Smooth grip for comfortable handling
- One complete, fully-contained unit
- For use with all GreenLine® laryngoscope blades
- LED illumination provides exceptional, clear viewing
- Complies with ISO 7376 Standard
- Non-sterile; packaged clean
- Mercury-free batteries pre-installed



CAT#	SIZE	DESCRIPTION	PK
5-0236-70	Penlite	Smooth Grip Disp. Handle	20

GreenLine®/D™ Fiber Optic Laryngoscope HANDLE WITH GRIP

LATEX FREE | STERILE | SINGLE PATIENT USE | DISPOSABLE

SunMed



- 5 year sterility and battery life
- Textured grip surface for more secure handling
- One complete, fully-contained unit
- For use with all GreenLine® laryngoscope blades
- LED illumination provides exceptional, clear viewing
- Complies with ISO 7376 Standard
- Mercury-free batteries pre-installed

CAT#	SIZE	DESCRIPTION	PK
5-5338-09	Medium	Textured Grip Disp. Handle	20
5-5338-10	Penlite	Textured Grip Disp. Handle	20
5-5338-11	Stubby	Textured Grip Disp. Handle	20
5-5338-12	Standard	Textured Grip Disp. Handle	20



GreenLine® Fiber Optic Laryngoscope
MACINTOSH GERMAN

LATEX FREE | REUSABLE

SunMed



- Built with an integral, extra large fiber optic bundle delivering a cool, white light
- Design eliminates cracks and crevices allowing superior cleaning and the prevention of cross contamination
- Not chrome plated
- Compliant with ISO standard 7376
- Green System compatible
- Constructed of 303/304 surgical stainless steel

CAT#	SIZE	DESCRIPTION	A	B	PK
5-5272-01	1	Infant	93mm	15mm	1
5-5272-02	2	Child	114mm	20mm	1
5-5272-13	3	Strong Curve Medium Adult	135mm	20mm	1
5-5272-03	3	Medium Adult	135mm	20mm	1
5-5272-04	4	Large Adult	155mm	20mm	1

GreenLine® Fiber Optic Laryngoscope
MACINTOSH GERMAN KIT

LATEX FREE | REUSABLE

SunMed



- Conveniently packaged laryngoscope kit with handle and blades
- High impact plastic case for easy transport
- Sturdy foam insert carefully protects components
- Includes medium handle with most popular Macintosh German profile blade sizes
- Reusable – all laryngoscope components can be reprocessed

CAT#	KIT INCLUDES	PK
5-5272-44	Medium Handle (5-0236-09), Macintosh Blades: 1 (5-5272-01), 2 (5-5272-02), 3 (5-5272-03), 4 (5-5272-04), Replacement Lamp (5-0240-53), Case (8-1050-73)	1 Kit



GreenLine® Fiber Optic Laryngoscope
MACINTOSH AMERICAN

LATEX FREE | REUSABLE



- Flange begins at the lock of blade, continues to where the curvature changes direction, and tapers off
- Soft, matte finish virtually eliminates reflection and glare
- Compliant with ISO standard 7376
- Green System compatible
- Constructed of 303/304 surgical stainless steel

CAT#	SIZE	DESCRIPTION	A	B	PK
5-5231-00	0	Newborn	80mm	15mm	1
5-5231-01	1	Infant	87mm	15mm	1
5-5231-02	2	Child	108mm	15mm	1
5-5231-03	3	Medium Adult	128mm	24mm	1
5-5231-35	3.5	Ext. Med. Adult	144mm	22mm	1
5-5231-04	4	Large Adult	159mm	15mm	1

GreenLine® Fiber Optic Laryngoscope
MACINTOSH AMERICAN KIT

LATEX FREE | REUSABLE



- Conveniently packaged laryngoscope kit with handle and blades
- High impact plastic case for easy transport
- Sturdy foam insert carefully protects components
- Includes medium handle with most popular Macintosh American profile blade sizes
- Reusable – all laryngoscope components can be reprocessed

CAT#	KIT INCLUDES	PK
5-5231-44	Medium Handle (5-0236-09), Macintosh Blades: 1 (5-5231-01), 2 (5-5231-02), 3 (5-5231-03), 4 (5-5231-04), Replacement Lamp (5-0240-53), Case (8-1050-73)	1 Kit

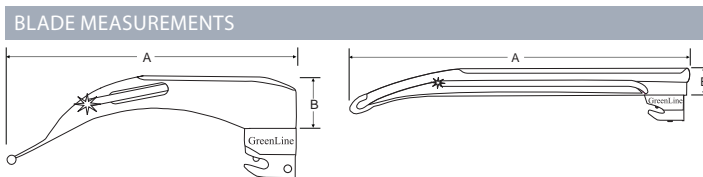

GreenLine® Fiber Optic Laryngoscope
IMPROVED VIEW AMERICAN

LATEX FREE | REUSABLE

SunMed



- Channel extends from heel to mid-blade for improved visualization of the cords
- Channel design helps guide endotracheal tube insertion
- Soft, matte finish virtually eliminates reflection and glare
- Compliant with ISO standard 7376
- Green System compatible
- Constructed of 303/304 surgical stainless steel

CAT#	SIZE	DESCRIPTION	A	B	PK
5-5254-02	2	Child	100mm	18mm	1
5-5254-03	3	Medium Adult	130mm	24mm	1
5-5254-35	3.5	Ext. Med. Adult	145mm	25mm	1
5-5254-04	4	Large Adult	155mm	26mm	1

GreenLine® Fiber Optic Laryngoscope
FLANGE-LESS AMERICAN

LATEX FREE | REUSABLE

SunMed

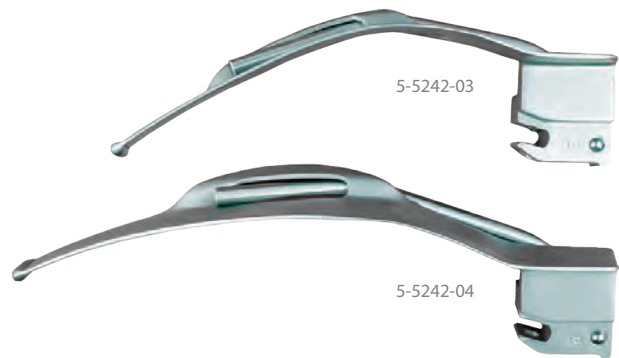

- Absent upper flange on curved blade is effective for use on patients with limited mouth opening, prominent incisors, receding mandible, short thick neck, or larynx in an extreme anterior anatomical position
- Design greatly reduces the potential trauma during laryngoscopy
- Soft, matte finish virtually eliminates reflection and glare
- Compliant with ISO standard 7376
- Green System compatible
- Constructed of 303/304 surgical stainless steel

CAT#	SIZE	DESCRIPTION	A	B	PK
5-5242-03	3	Medium Adult	130mm	8mm	1
5-5242-04	4	Large Adult	158mm	8mm	1



GreenLine® Fiber Optic Laryngoscope
BLECHMAN AMERICAN

LATEX FREE | REUSABLE



- Angled tip elevates the epiglottis in supine patient
- Tongue is swept to the left allowing the blade to tip upward for effective viewing from the right side
- Soft, matte finish virtually eliminates reflection and glare
- Compliant with ISO standard 7376
- Green System compatible
- Constructed of 303/304 surgical stainless steel

CAT#	SIZE	DESCRIPTION	A	B	PK
5-5241-03	3	Medium Adult	148mm	13mm	1

GreenLine® Fiber Optic Laryngoscope
PRISMVIEW AMERICAN

LATEX FREE | REUSABLE



- Designed with an optically polished prism with 30° refraction without image inversion
- Ideal when the view of the vocal cords is impaired, (especially the most anterior larynx), during nasal intubation, and for post operative examination of the larynx
- Prevent condensation by immersing blade in warm water bath for 10 minutes prior to use
- Soft, matte finish virtually eliminates reflection and glare
- Compliant with ISO standard 7376
- Green System compatible
- Constructed of 303/304 surgical stainless steel

CAT#	SIZE	DESCRIPTION	A	B	PK
5-5229-02	2	Child	100mm	17mm	1
5-5229-03	3	Medium Adult	130mm	24mm	1
5-5229-35	3.5	Ext. Medium Adult	144mm	25mm	1
5-5229-04	4	Large Adult	155mm	26mm	1

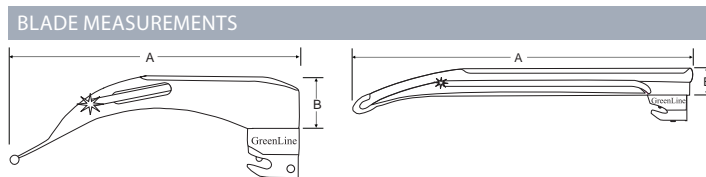

GreenLine® Fiber Optic Laryngoscope
MACINTOSH ENGLISH

LATEX FREE | REUSABLE

SunMed



- Designed with a gentle curvature
- Flange begins at the lock of blade and continues to the tip as it narrows
- Soft, matte finish virtually eliminates reflection and glare
- Compliant with ISO standard 7376
- Green System compatible
- Constructed of 303/304 surgical stainless steel



CAT#	SIZE	DESCRIPTION	A	B	PK
5-5232-01	1	Infant	92mm	22mm	1
5-5232-02	2	Child	100mm	21mm	1
5-5232-03	3	Medium Adult	130mm	22mm	1
5-5232-04	4	Large Adult	155mm	25mm	1
5-5232-05	5	Extra Lg. Adult	175mm	22mm	1
5-5243-03	3	Left Hand Adult	130mm	22mm	1

GreenLine® Fiber Optic Laryngoscope
POLIO ENGLISH

LATEX FREE | REUSABLE

SunMed



- Modified Macintosh English profile blade for indirect laryngoscopy
- Blade is offset from handle at an obtuse angle to allow intubation of patients on respirators, in body jackets, as well as other difficult intubation scenarios
- Soft, matte finish virtually eliminates reflection and glare
- Compliant with ISO standard 7376
- Green System compatible
- Constructed of 303/304 surgical stainless steel

CAT#	SIZE	DESCRIPTION	A	B	PK
5-5247-03	3	Medium Adult Angled at 120°	130mm	23mm	1



GreenLine® Fiber Optic Laryngoscope
IMPROVED VISION ENGLISH

LATEX FREE | REUSABLE



- Channel extends from heel to mid-blade for improved visualization of the cords
- Channel design helps guide endotracheal tube insertion
- Soft, matte finish virtually eliminates reflection and glare
- Compliant with ISO standard 7376
- Green System compatible
- Constructed of 303/304 surgical stainless steel

CAT#	SIZE	DESCRIPTION	A	B	PK
5-5246-02	2	Child	100mm	21mm	1
5-5246-03	3	Medium Adult	130mm	23mm	1
5-5246-35	3.5	Ext. Medium Adult	145mm	24mm	1
5-5246-04	4	Large Adult	155mm	25mm	1

GreenLine® Fiber Optic Laryngoscope
PRISMVIEW ENGLISH

LATEX FREE | REUSABLE



- Designed with an optically polished prism with 30° refraction without image inversion
- Ideal when the view of the vocal cords is impaired, (especially the most anterior larynx), during nasal intubation, and for post operative examination of the larynx
- Prevent condensation by immersing blade in warm water bath for 10 minutes prior to use
- Soft, matte finish virtually eliminates reflection and glare
- Compliant with ISO standard 7376
- Green System compatible
- Constructed of 303/304 surgical stainless steel

CAT#	SIZE	DESCRIPTION	A	B	PK
5-5228-02	2	Child	100mm	17mm	1
5-5228-03	3	Medium Adult	130mm	24mm	1
5-5228-35	3.5	Ext. Med. Adult	144mm	25mm	1
5-5228-04	4	Large Adult	155mm	26mm	1

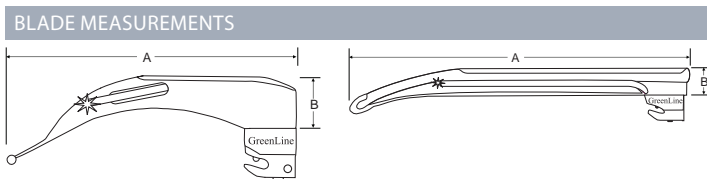

GreenLine® Fiber Optic Laryngoscope
SUNFLEX ENGLISH

LATEX FREE | REUSABLE

SunMed

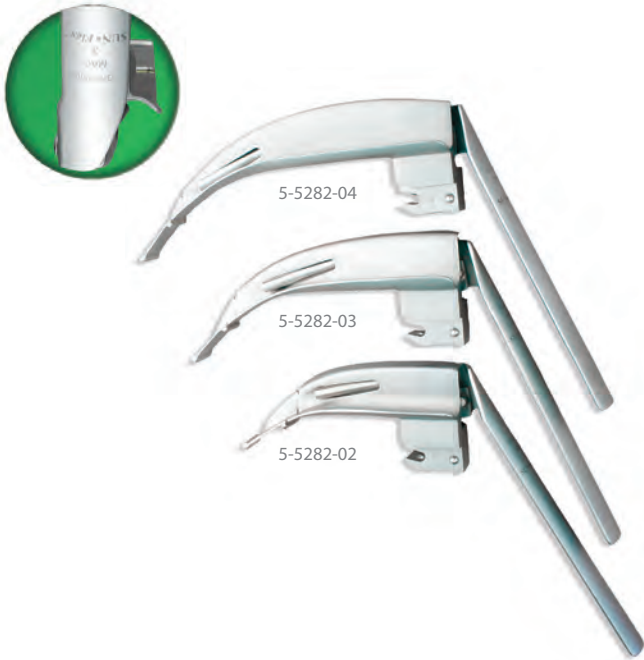

- English channel helps visualization the epiglottis
- Designed to enable precise control to elevate the epiglottis
- Non-pinching tip
- Soft, matte finish virtually eliminates reflection and glare
- Compliant with ISO standard 7376
- Green System compatible
- Constructed of 303/304 surgical stainless steel

CAT#	SIZE	DESCRIPTION	A	B	PK
5-5282-02	2	Child	102mm	20mm	1
5-5282-03	3	Medium Adult	132mm	23mm	1
5-5282-04	4	Large Adult	155mm	26mm	1

GreenLine® Fiber Optic Laryngoscope
REDUCED FLANGE E-MAC™

LATEX FREE | REUSABLE

SunMed

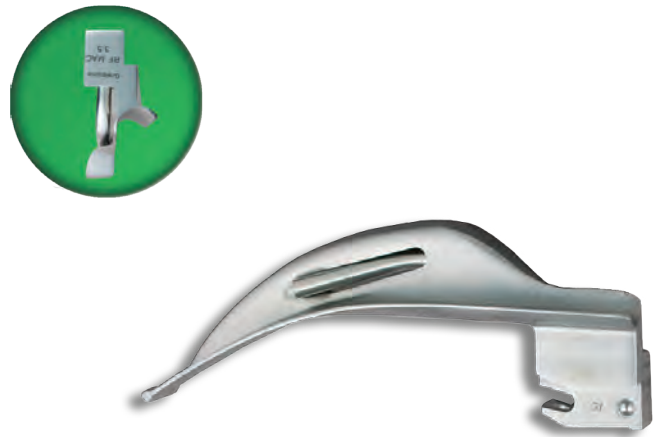

- Channel extends from heel to mid-blade for improved visualization of the cords
- Channel design helps guide endotracheal tube insertion
- Soft, matte finish virtually eliminates reflection and glare
- Compliant with ISO standard 7376
- Green System compatible
- Constructed of 303/304 surgical stainless steel

CAT#	SIZE	DESCRIPTION	A	B	PK
5-5271-02	2	Child	100mm	21mm	1
5-5271-03	3	Medium Adult	130mm	23mm	1
5-5271-35	3.5	Ext. Medium Adult	145mm	24mm	1
5-5271-04	4	Large Adult	155mm	26mm	1

BLADE MEASUREMENTS

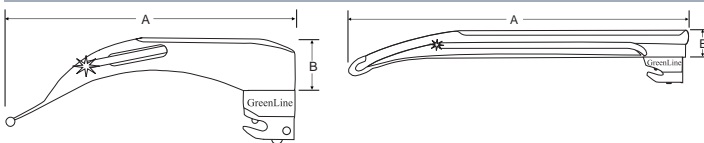

GreenLine® Fiber Optic Laryngoscope
SIKER MIRROR ENGLISH

LATEX FREE | REUSABLE



- Ideal for use on patients with anatomical variations which make intubation with conventional blades difficult or impossible
- The basic portions of the blade make an angle of 135° with a mirror located at flange angle facing spatula for better visualization during intubation
- Distal portion is 3"
- Since mirror inverts the reflected image, operator should exercise caution until familiar with its use
- Curved stylette is recommended for use with the Siker blade
- Immersing blade in warm water bath for 10 minutes prior to use will prevent mirror fogging
- Soft, matte finish virtually eliminates reflection and glare
- Compliant with ISO standard 7376
- Green System compatible
- Constructed of 303/304 surgical stainless steel

CAT#	SIZE	DESCRIPTION	A	B	PK
5-5245-04	4	Large Adult	158mm	18mm	1

GreenLine® Fiber Optic Laryngoscope
MILLER GERMAN

LATEX FREE | REUSABLE



- Built with an integral, extra large fiber optic bundle delivering a cool, white light
- Design eliminates cracks and crevices allowing superior cleaning and the prevention of cross contamination
- Not chrome plated
- Compliant with ISO standard 7376
- Green System compatible
- Constructed of 303/304 surgical stainless steel

CAT#	SIZE	DESCRIPTION	A	B	PK
5-5273-20	00	Premature	65mm	11mm	1
5-5273-00	0	Newborn	77mm	12mm	1
5-5273-01	1	Infant	110mm	12mm	1
5-5273-15	1.5	Small Child	130mm	14mm	1
5-5273-02	2	Child	152mm	14mm	1
5-5273-03	3	Medium Adult	192mm	15mm	1
5-5273-04	4	Large Adult	207mm	16mm	1



GreenLine® Fiber Optic Laryngoscope

MILLER AMERICAN

LATEX FREE | REUSABLE

SunMed

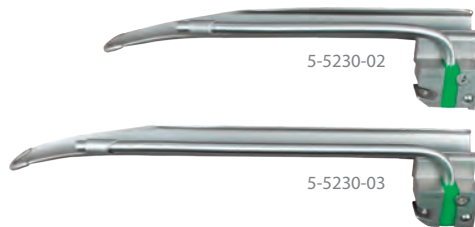

- Light-on-right American profile
- Miller design is predominant choice among straight blades
- Reduced flange helps minimize trauma
- Distal end curve improves lifting of epiglottis
- Designed to facilitate greater exposure of larynx
- Soft, matte finish virtually eliminates reflection and glare
- Compliant with ISO standard 7376
- Green System compatible
- Constructed of 303/304 surgical stainless steel

CAT#	SIZE	DESCRIPTION	A	B	PK
5-5230-02	2	Child	155mm	13mm	1
5-5230-03	3	Medium Adult	195mm	13mm	1

GreenLine® Fiber Optic Laryngoscope

SNOW AMERICAN

LATEX FREE | REUSABLE

SunMed



- Combined Miller spatula and the Wis-Foregger flange design can reduce trauma during intubation, especially for use with a cuffed tube
- Curves back from the distal end for a convenient visual field
- Soft, matte finish virtually eliminates reflection and glare
- Compliant with ISO standard 7376
- Green System compatible
- Constructed of 303/304 surgical stainless steel

CAT#	SIZE	DESCRIPTION	A	B	PK
5-5249-03	3	Medium Adult	162mm	16mm	1



GreenLine® Fiber Optic Laryngoscope
CRANWALL AMERICAN

LATEX FREE | REUSABLE

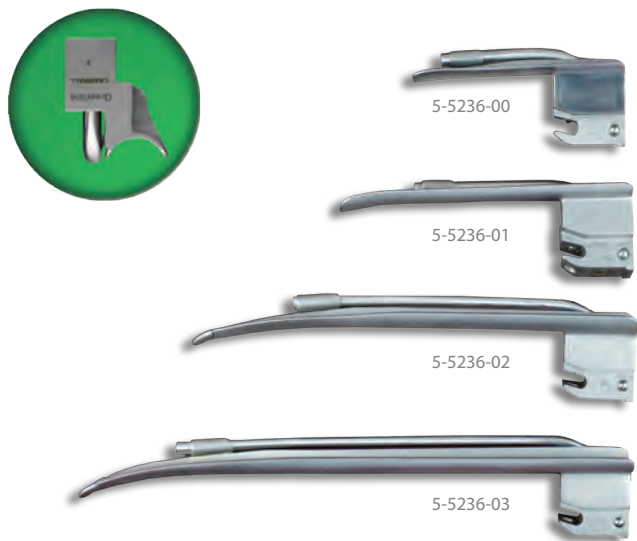

- Reduced flange allows easier insertion through a restricted opening, such as arthritic jaw or facial burns
- Design helps decrease potential damage to upper teeth
- Flange removed directly below the light carrier
- Can easily be used as a left-handed straight blade
- Soft, matte finish virtually eliminates reflection and glare
- Compliant with ISO standard 7376
- Green System compatible
- Constructed of 303/304 surgical stainless steel

CAT#	SIZE	DESCRIPTION	A	B	PK
5-5236-00	0	Newborn	75mm	10mm	1
5-5236-01	1	Infant	100mm	11mm	1
5-5236-02	2	Child	157mm	11mm	1
5-5236-03	3	Medium Adult	195mm	12mm	1

GreenLine® Fiber Optic Laryngoscope
MILLER-PORT AMERICAN

LATEX FREE | REUSABLE



- Specifically designed to perform laryngoscopy and intubation with reduced risk of hypoxia
- Integrated tube permits delivery of oxygen or other gas mixtures during intubation
- Soft, matte finish virtually eliminates reflection and glare
- Compliant with ISO standard 7376
- Green System compatible
- Constructed of 303/304 surgical stainless steel

CAT#	SIZE	DESCRIPTION	A	B	PK
5-5248-00	0	Newborn	75mm	10mm	1
5-5248-01	1	Infant	102mm	10mm	1

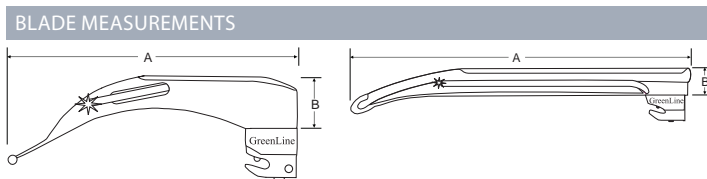

GreenLine® Fiber Optic Laryngoscope
WISCONSIN AMERICAN

LATEX FREE | REUSABLE

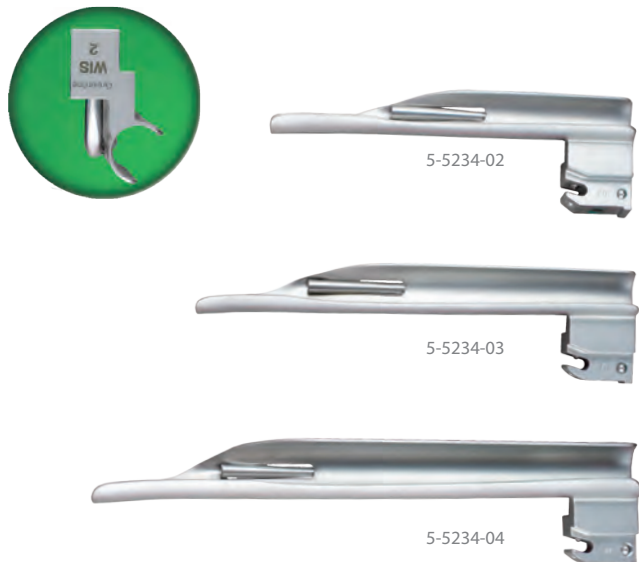

- Straight spatula design with flange that expands slightly toward the distal portion of the blade increases visual field helping to prevent potential trauma during intubation
- Distal portion of the blade is wider and formed slightly to the right, making it well-adapted to lifting the epiglottis
- Soft, matte finish virtually eliminates reflection and glare
- Compliant with ISO standard 7376
- Green System compatible
- Constructed of 303/304 surgical stainless steel

CAT#	SIZE	DESCRIPTION	A	B	PK
5-5234-02	2	Child	135mm	18mm	1
5-5234-03	3	Medium Adult	162mm	17mm	1
5-5234-04	4	Large Adult	199mm	21mm	1

GreenLine® Fiber Optic Laryngoscope
WIS-HIPPLE AMERICAN

LATEX FREE | REUSABLE

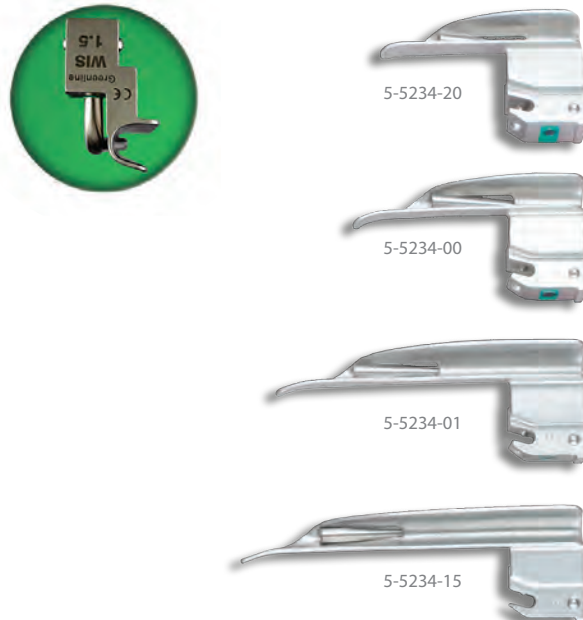

- Wisconsin-modified blade with a straight spatula and a large, circular flange
- Flange tends to be straighter than a Wisconsin blade and runs parallel with the spatula
- Designed primarily for use in infants
- Wider, flat tip is well-adapted to lifting the epiglottis
- Soft, matte finish virtually eliminates reflection and glare
- Compliant with ISO standard 7376
- Green System compatible
- Constructed of 303/304 surgical stainless steel

CAT#	SIZE	DESCRIPTION	A	B	PK
5-5234-20	00	Premature	65mm	13mm	1
5-5234-00	0	Newborn	76mm	13mm	1
5-5234-01	1	Infant	102mm	13mm	1
5-5234-15	1.5	Small Child	115mm	14mm	1



GreenLine® Fiber Optic Laryngoscope
WHITEHEAD AMERICAN

LATEX FREE | REUSABLE



GreenLine® Fiber Optic Laryngoscope
PHILLIPS AMERICAN

LATEX FREE | REUSABLE



- Reduced flange increases visualization to facilitate intubation
- Designed to reduce potential damage to incisors
- Soft, matte finish virtually eliminates reflection and glare
- Compliant with ISO standard 7376
- Green System compatible
- Constructed of 303/304 surgical stainless steel

- Combines the straight Jackson blade design with the curved distal tip Miller design to allow greater visibility and a 'direct line' approach to the trachea
- Low profile flange reduces the risks of oral damage
- Unique lamp mounting enables deep illumination both downward and inward
- Soft, matte finish virtually eliminates reflection and glare
- Compliant with ISO standard 7376
- Green System compatible
- Constructed of 303/304 surgical stainless steel

CAT#	SIZE	DESCRIPTION	A	B	PK
5-5244-03	3	Medium Adult	162mm	15mm	1

CAT#	SIZE	DESCRIPTION	A	B	PK
5-5235-01	1	Child	113mm	13mm	1
5-5235-02	2	Adult	166mm	18mm	1

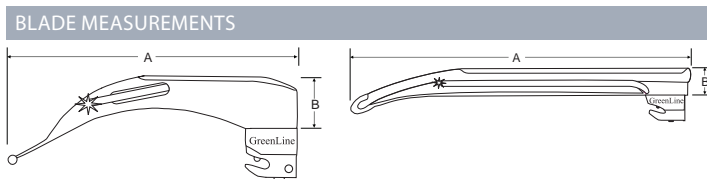

GreenLine® Fiber Optic Laryngoscope
MILLER ENGLISH

LATEX FREE | REUSABLE

SunMed

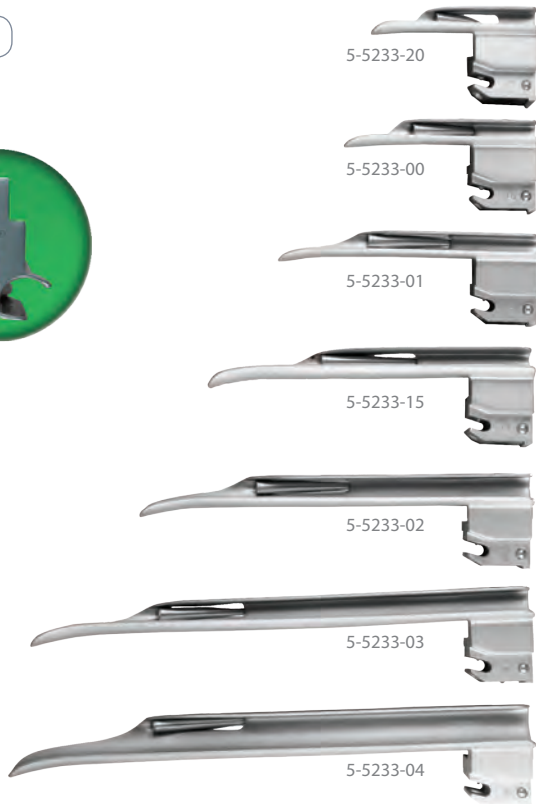

- Miller design is predominant choice among straight blades
- Reduced flange helps minimize trauma
- Distal end curve improves lifting of epiglottis
- Designed to facilitate greater exposure of larynx
- Soft, matte finish virtually eliminates reflection and glare
- Compliant with ISO standard 7376
- Green System compatible
- Constructed of 303/304 surgical stainless steel

CAT#	SIZE	DESCRIPTION	A	B	PK
5-5233-20	00	Premature	67mm	10mm	1
5-5233-00	0	Newborn	77mm	10mm	1
5-5233-01	1	Infant	102mm	10mm	1
5-5233-15	1.5	Small Child	130mm	12mm	1
5-5233-02	2	Child	153mm	12mm	1
5-5233-03	3	Medium Adult	195mm	12mm	1
5-5233-04	4	Large Adult	205mm	16mm	1

GreenLine® Fiber Optic Laryngoscope
SEWARD ENGLISH

LATEX FREE | REUSABLE

SunMed



- Originally produced as an infant blade for use in asphyxia neonatorum, it is now available to fit older children
- Soft, matte finish virtually eliminates reflection and glare
- Compliant with ISO standard 7376
- Green System compatible
- Constructed of 303/304 surgical stainless steel

CAT#	SIZE	DESCRIPTION	A	B	PK
5-5239-01	1	Infant	105mm	9mm	1
5-5239-02	2	Child	130mm	16mm	1

BLADE MEASUREMENTS

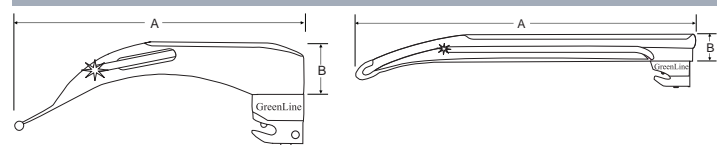

GreenLine® Fiber Optic Laryngoscope
ROBERTSHAW ENGLISH

LATEX FREE | REUSABLE

SunMed



- Designed specifically for infants and children
- Spatula is gently curved over the distal third and can indirectly lift the epiglottis similar to a Macintosh blade
- Permits binocular vision allowing better judgment of depth and consequently less risk of trauma
- Soft, matte finish virtually eliminates reflection and glare
- Compliant with ISO standard 7376
- Green System compatible
- Constructed of 303/304 surgical stainless steel

CAT#	SIZE	DESCRIPTION	A	B	PK
5-5237-00	0	Newborn	94mm	11mm	1
5-5237-01	1	Infant	112mm	13mm	1

GreenLine® Fiber Optic Laryngoscope
SOPER ENGLISH

LATEX FREE | REUSABLE

SunMed



- Broad flat blade makes it easier to restrict premature and newborn infant tongue movement
- Soft, matte finish virtually eliminates reflection and glare
- Compliant with ISO standard 7376
- Green System compatible
- Constructed of 303/304 surgical stainless steel

CAT#	SIZE	DESCRIPTION	A	B	PK
5-5240-01	1	Infant	100mm	17mm	1

GreenLine® Fiber Optic Laryngoscope
OXFORD ENGLISH

LATEX FREE | REUSABLE

SunMed



- Suitable for premature infants, babies and young children up to 4yrs
- Overhang on the open side prevents lips from obscuring vision
- Broad, flat surface aids pediatric patients with extreme cleft palates
- Soft, matte finish virtually eliminates reflection and glare
- Compliant with ISO standard 7376
- Green System compatible
- Constructed of 303/304 surgical stainless steel

CAT#	SIZE	DESCRIPTION	A	B	PK
5-5238-01	1	Infant	102mm	16mm	1



GreenLine® Fiber Optic Laryngoscope

REPLACEMENT HANDLE LAMPS

LATEX FREE | REUSABLE



- For use in fiber optic reusable handles
- Meets stringent manufacturing controls
- Contact Customer Care for correct lamp selection

NEWLY DESIGNED REMOVABLE LAMP CARTRIDGES:

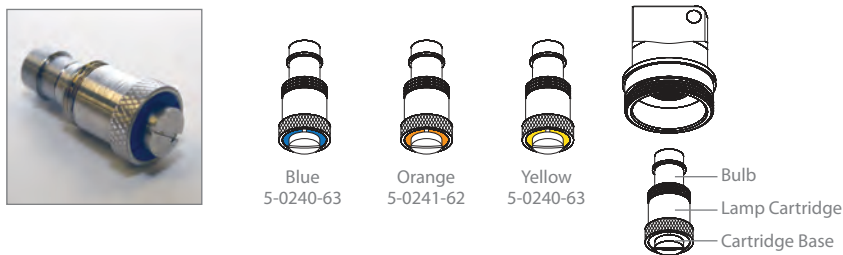

CAT#	LAMP TYPE	DESCRIPTION	COMPATIBILITY	PK
5-0240-61	Halogen Xenon	Blue Cartridge Base	GreenLine FO Handles (2015 and newer): 5-0236-09, 5-0236-10, 5-0236-11, 5-0236-15, 5-0236-30, 5-023-31, 5-0236-35, 5-0236-36, 5-0236-38, 5-0236-39	1
5-0241-62	Eco LED	Orange Cartridge Base	GreenLine SunBrite FO Handles (2015 and newer): 5-0236-90, 5-0236-91, 5-0236-99	1
5-0240-63	High End LED	Yellow Cartridge Base	LED FO Handles (2015 and newer): 5-0236-80, 5-0236-89	1
5-0240-52		Red Cartridge Base	GreenLine FO Handles (pre-2012): 5-0236-09, 5-0236-10, 5-0236-11, 5-0236-15, 5-0236-30, 5-023-31, 5-0236-35, 5-0236-36, 5-0236-38, 5-0236-39	1
5-0240-53		Gold Cartridge	GreenLine FO Handles (2012-2015): 5-0236-09, 5-0236-10, 5-0236-11, 5-0236-15, 5-0236-30, 5-023-31, 5-0236-35, 5-0236-36, 5-0236-38, 5-0236-39	1
5-0238-59		No Threads		1
5-0238-60		Large Thread		1
5-0240-59		Black Cartridge Base	GreenLine FO Handles (pre-2007): 5-0236-09, 5-0236-10, 5-0236-11, 5-0236-15, 5-0236-30, 5-023-31, 5-0236-35, 5-0236-36, 5-0236-38, 5-0236-39	1



GreenLine® Fiber Optic Laryngoscope

CHROME PLATED

LATEX FREE | REUSABLE



GreenLine® Fiber Optic Laryngoscope

PREMIUM CHROME PLATED

LATEX FREE | REUSABLE



- Compatible with all Green System fiber optic blades
- Chrome plated brass
- Bright Halogenated Xenon lamp
- Batteries not included

- Compatible with all Green System fiber optic blades
- Chrome plated brass
- Premium LED handles have a lifetime warranty
- Low power use prolongs battery life
- Compliant with ISO standard 7376
- Autoclavable
- Batteries not included

CAT#	SIZE	DESCRIPTION	BATTERIES	PK
5-0236-09	Medium	Chrome Plated Brass	2 "C"	1
5-0236-10	Penlite	Chrome Plated Brass	2 "AA"	1
5-0236-11	Stubby	Chrome Plated Brass	2 "AAA"	1
5-0236-15	Large	Chrome Plated Brass	2 "D"	1

CAT#	SIZE	DESCRIPTION	BATTERIES	PK
5-0236-80	Penlite	Lifetime LED	2 "AA"	1
5-0236-89	Medium	Lifetime LED	2 "C"	1



GreenLine® Fiber Optic Laryngoscope

STAINLESS STEEL

LATEX FREE | REUSABLE



GreenLine® Fiber Optic Laryngoscope

PREMIUM STAINLESS STEEL

LATEX FREE | REUSABLE



- Compatible with all Green System fiber optic blades
- Bright Halogenated Xenon lamp
- Batteries not included

- Compatible with all Green System fiber optic blades
- Premium LED handles have a lifetime warranty
- Low power use prolongs battery life
- Compliant with ISO standard 7376
- Autoclavable
- Batteries not included

CAT#	SIZE	DESCRIPTION	BATTERIES	PK
5-0236-39	Medium	Stainless Steel	2 "C"	1
5-0236-30	Penlite	Stainless Steel	2 "AA"	1
5-0236-31	Stubby	Stainless Steel	2 "AAA"	1
5-0236-35	Large	Stainless Steel	2 "D"	1
5-0236-38	Mini	Stainless Steel	Lithium 123	1
5-0236-36	Micro	Stainless Steel	Lithium 123	1

CAT#	SIZE	DESCRIPTION	BATTERIES	PK
5-0246-80	Penlite	Premium Stainless	2 "AA"	1
5-0246-81	Stubby	Premium Stainless	2 "AAA"	1
5-0246-86	Micro	Premium Stainless	Lithium 123	1
5-0246-88	Mini	Premium Stainless	Lithium 123	1
5-0246-89	Medium	Premium Stainless	2 "C"	1



GreenLine® Fiber Optic Laryngoscope

SUNBRITE LED

LATEX FREE | REUSABLE



GreenLine® Fiber Optic Laryngoscope

HOWLAND LOCK

LATEX FREE | REUSABLE



- Compatible with all Green System fiber optic blades
- Chrome plated brass
- Low power use prolongs battery life
- Cool, white illumination
- Autoclavable
- Batteries not included

- Natural lifting simplifies laryngeal exposure, making intubation possible even in the most difficult cases
- Built-in leverage decreases prying and reduces possibility of broken teeth
- Compatible with Green System fiber optic handles and blades
- Can often make an otherwise certain tracheotomy unnecessary

CAT#	SIZE	DESCRIPTION	BATTERIES	PK
5-0236-90	Penlite	SunBrite LED	2 "AA"	1
5-0236-91	Stubby	SunBrite LED	2 "AAA"	1
5-0236-99	Medium	SunBrite LED	2 "C"	1

CAT#	DESCRIPTION	PK
5-0236-16	Fiber Optic Howland Lock	1



GreenLine® Fiber Optic Laryngoscope
INTUBATION KIT

LATEX FREE



8-1050-95 Fiber Optic Intubation Kit
 Batteries, lubricating jelly, and syringe not shown.

Complete intubation kits available with conventional, fiber optic or fiber optic disposable laryngoscope blades

Each kit includes:

- 8 Oropharyngeal color coded Guedel airways (sizes 40mm-100mm)
- 1 Penlite chrome plated fiber optic laryngoscope handle
- 1 Medium chrome plated fiber optic laryngoscope handle
- 5 Miller laryngoscope blades (sizes 0-4)
- 4 Macintosh laryngoscope blades (sizes 1-4)
- 4 Extra laryngoscope lamps (2 small, 2 large)
- 1 Adult Magill forceps
- 1 Pediatric Magill forceps
- 2 "C" batteries
- 2 "AA" batteries
- 4 Packets of sterile lubricating jelly
- 2 Endotracheal uncuffed tubes (sizes 2.5, 4mm)
- 8 Endotracheal cuffed tubes (sizes 5-10mm)
- 4 Nasopharyngeal airways (sizes 20, 24, 28, 32Fr)
- 1 10ml syringe
- 1 Endotracheal tube introducer (bougie) with coude tip
- 1 Adult stylette
- 1 Nylon airway management case

CAT#	KIT INCLUDES	PK
8-1050-95	Fiber Optic Intubation Kit Includes items above + Reusable FO Laryngoscope Blades	1 Kit
8-1050-94	Single-Use Fiber Optic Intubation Kit Includes items above + Disposable FO Single Use Laryngoscope Blades	1 Kit
8-1050-80	Nylon Case Only	1



GreenLine® Fiber Optic Laryngoscope

DISPOSABLE LARYNGOSCOPE KITS

LATEX FREE | SINGLE USE | DISPOSABLE

SunMed



- Ideal for ambulances, paramedics and first responders
- Variety of blade/handle combinations in most popular sizes
- All blades are single patient use and disposable
- Available with either single use or reusable handles
- Components arrive in original packaging inside sturdy canvas pouch

CAT#	KIT INCLUDES	PK
5-5332-55	2 Disposable Standard Handles (5-5338-12) Macintosh Blades: 2 (5-5332-02), 3 (5-5332-03), 4 (5-5332-04), Miller Blades: 2 (5-5333-02), 3 (5-5333-03), Canvas Pouch	1 Kit
5-5332-57	Disposable Standard Handle (5-5338-12) Disposable Stubby Handle (5-5338-11) Macintosh Blades: 2 (5-5332-02), 3 (5-5332-03), 4 (5-5332-04), Miller Blades: 2 (5-5333-02), 3 (5-5333-03), Canvas Pouch	1 Kit
5-5336-54	2 Disposable Penlite Handles (5-5338-10) All-Metal Macintosh Blade: 1 (5-5335-01), All-Metal Miller Blades: 00 (5-5336-20), 0 (5-5336-00), 1 (5-5336-01) Canvas Pouch	1 Kit
5-5333-58	2 Disposable Standard Handles (5-5338-12) Macintosh Blades: 2 (5-5332-02), 3 (5-5332-03), 4 (5-5332-04), Miller Blades: 0 (5-5333-20), 1 (5-5333-01), 2 (5-5333-02), 3 (5-5333-03), Canvas Pouch	1 Kit
5-5333-57	Chrome Plated Med. Handle (5-0236-09) Macintosh Blades: 2 (5-5332-02), 3 (5-5332-03), 4 (5-5332-04), Miller Blades: 0 (5-5333-20), 1 (5-5333-01), 2 (5-5333-02), 3 (5-5333-03), Canvas Pouch	1 Kit
5-5335-47	Chrome Plated Med. Handle (5-0236-99) All-Metal Macintosh Blades: 2 (5-5335-02), 3 (5-5335-03), 4 (5-5335-04) All-Metal Miller Blades: 0 (5-5336-00), 1 (5-5336-01), 2 (5-5336-02), 3 (5-5336-03) Canvas Pouch	1 Kit

DISPOSABLE KITS + DISPOSABLE HANDLES

5-5332-55
GreenLine/D,
5 Blades,
Standard Kit

5-5332-57
GreenLine/D,
5 Blades,
Stubby Kit

5-5336-54
All-Metal,
4 Blades,
Penlite Kit

5-5333-58
GreenLine/D,
7 Blades,
Standard Kit

DISPOSABLE KITS + REUSABLE CHROME PLATED HANDLES

5-5333-57
GreenLine/D,
7 Blades,
Chrome Kit

5-5335-47
All-Metal,
7 Blades,
Chrome Kit



GreenLine® Fiber Optic Laryngoscope

REUSABLE LARYNGOSCOPE KITS

LATEX FREE | REUSABLE

SunMed

- All blades and handles compatible with Welch Allyn, Propper, Rusch, Heine and AMS
- Blades available in Macintosh and Miller, American, English and German profiles
- High impact plastic case for easy transport



Macintosh English Profile



Miller English Profile

MACINTOSH ENGLISH PROFILE

CAT#	KIT INCLUDES	PK
5-5232-44	Medium Handle (5-0236-09), Replacement Lamp (5-0240-53), Macintosh Blades: 1 (5-5232-01), 2 (5-5232-02), 3 (5-5232-03), 4 (5-5232-04), Case (8-1050-73)	1 Kit
5-5232-45	Medium Premium LED Handle (5-0236-89), Macintosh Blades: 1 (5-5232-01), 2 (5-5232-02), 3 (5-5232-03), 4 (5-5232-04), Case (8-1050-73)	1 Kit
5-5232-46	Medium SunBrite Handle (5-0236-99), Macintosh Blades: 1 (5-5232-01), 2 (5-5232-02), 3 (5-5232-03), 4 (5-5232-04), Case (8-1050-73)	1 Kit

MILLER ENGLISH PROFILE

CAT#	KIT INCLUDES	PK
5-5233-44	Medium SunBrite Handle (5-0236-99), Miller Blades: 0 (5-5233-00), 1 (5-5233-01), 2 (5-5233-02), 3 (5-5233-03), 4 (5-5233-04), Case (8-1050-71)	1 Kit
5-5233-45	Medium Handle (5-0236-09), Replacement Lamp (5-0240-53), Miller Blades: 0 (5-5233-00), 1 (5-5233-01), 2 (5-5233-02), 3 (5-5233-03), 4 (5-5233-04), Case (8-1050-71)	1 Kit
5-5233-46	Medium Premium LED Handle (5-0236-89), Miller Blades: 0 (5-5233-00), 1 (5-5233-01), 2 (5-5233-02), 3 (5-5233-03), 4 (5-5233-04), Case (8-1050-71)	1 Kit

MACINTOSH AMERICAN PROFILE

CAT#	KIT INCLUDES	PK
5-5231-44	Medium Handle (5-0236-09), Replacement Lamp (5-0240-53), Macintosh Blades: 1 (5-5231-01), 2 (5-5231-02), 3 (5-5231-03), 4 (5-5231-04), Case (8-1050-73)	1 Kit
5-5231-45	Medium Premium LED Handle (5-0236-89), Macintosh Blades: 1 (5-5231-01), 2 (5-5231-02), 3 (5-5231-03), 4 (5-5231-04), Case (8-1050-73)	1 Kit
5-5231-46	Medium SunBrite Handle (5-0236-99), Macintosh Blades: 1 (5-5231-01), 2 (5-5231-02), 3 (5-5231-03), 4 (5-5231-04), Case (8-1050-73)	1 Kit

MACINTOSH / MILLER

CAT#	KIT INCLUDES	PK
5-5233-47	Medium Handle (5-0236-09), Replacement Lamp (5-0240-53), Macintosh Blades: 2 (5-5232-02), 3 (5-5232-03), 4 (5-5232-04), Miller Blades: 0 (5-5233-00), 1 (5-5233-01), 2 (5-5233-02), 3 (5-5233-03), Case (8-1050-77)	1 Kit
5-5233-48	Medium Premium LED Handle (5-0236-89), Macintosh Blades: 2 (5-5232-02), 3 (5-5232-03), 4 (5-5232-04), Miller Blades: 0 (5-5233-00), 1 (5-5233-01), 2 (5-5233-02), 3 (5-5233-03), Case (8-1050-77)	1 Kit
5-5233-49	Medium SunBrite Handle (5-0236-99), Macintosh Blades: 2 (5-5232-02), 3 (5-5232-03), 4 (5-5232-04), Miller Blades: 0 (5-5233-00), 1 (5-5233-01), 2 (5-5233-02), 3 (5-5233-03), Case (8-1050-77)	1 Kit





Macintosh/Miller



Macintosh German Profile



Macintosh/Miller German Profile



SunFlex

MACINTOSH GERMAN PROFILE

CAT#	KIT INCLUDES	PK
5-5272-44	Medium Handle (5-0236-09), Replacement Lamp (5-0240-53), Macintosh Blades: 1 (5-5272-01), 2 (5-5272-02), 3 (5-5272-03), 4 (5-5272-04), Case (8-1050-73)	1 Kit
5-5272-45	Medium Premium LED Handle (5-0236-89), Macintosh Blades: 1 (5-5272-01), 2 (5-5272-02), 3 (5-5272-03), 4 (5-5272-04), Case (8-1050-73)	1 Kit
5-5272-46	Medium SunBrite Handle (5-0236-99), Macintosh Blades: 1 (5-5272-01), 2 (5-5272-02), 3 (5-5272-03), 4 (5-5272-04), Case (8-1050-73)	1 Kit

MACINTOSH / MILLER GERMAN PROFILE

CAT#	KIT INCLUDES	PK
5-5272-47	Medium Handle (5-0236-09), Replacement Lamp (5-0240-53), Macintosh Blades: 2 (5-5272-02), 3 (5-5272-03), 4 (5-5272-04) Miller Blades: 0 (5-5273-00), 1 (5-5273-01), 2 (5-5273-02), 3 (5-5273-03), Case (8-1050-77)	1 Kit
5-5272-48	Medium Premium LED Handle (5-0236-89), Macintosh Blades: 2 (5-5272-02), 3 (5-5272-03), 4 (5-5272-04) Miller Blades: 0 (5-5273-00), 1 (5-5273-01), 2 (5-5273-02), 3 (5-5273-03), Case (8-1050-77)	1 Kit
5-5272-49	Medium SunBrite Handle (5-0236-99), Macintosh Blades: 2 (5-5272-02), 3 (5-5272-03), 4 (5-5272-04) Miller Blades: 0 (5-5273-00), 1 (5-5273-01), 2 (5-5273-02), 3 (5-5273-03), Case (8-1050-77)	1 Kit

MILLER GERMAN PROFILE

CAT#	KIT INCLUDES	PK
5-5273-45	Medium Handle (5-0236-09), Replacement Lamp (5-0240-53), Miller Blades: 0 (5-5273-00), 1 (5-5273-01), 2 (5-5273-02), 3 (5-5273-03), 4 (5-5273-04), Case (8-1050-71)	1 Kit
5-5273-46	Medium Premium LED Handle (5-0236-89), Miller Blades: 0 (5-5273-00), 1 (5-5273-01), 2 (5-5273-02), 3 (5-5273-03), 4 (5-5273-04) Case (8-1050-71)	1 Kit
5-5273-47	Medium SunBrite Handle (5-0236-99), Miller Blades: 0 (5-5273-00), 1 (5-5273-01), 2 (5-5273-02), 3 (5-5273-03), 4 (5-5273-04) Case (8-1050-71)	1 Kit

SUNFLEX

CAT#	KIT INCLUDES	PK
5-5282-42	Medium Handle (5-0236-09) Replacement lamp (5-0240-53) SunFlex Blades: 3 (5-5282-03), 4 (5-5282-04), Case (8-1050-72)	1 Kit
5-5282-43	Medium Premium LED Handle (5-0236-89), SunFlex Blades: 3 (5-5282-03), 4 (5-5282-04) Case (8-1050-72)	1 Kit
5-5282-44	Medium SunBrite Handle (5-0236-89), SunFlex Blades: 3 (5-5282-03), 4 (5-5282-04) Case (8-1050-72)	1 Kit



Conventional Laryngoscope
LED STANDARD/D MACINTOSH

LATEX FREE | SINGLE PATIENT USE | DISPOSABLE



- Non-plastic, stainless steel single-use blade
- Eliminates the cost associated with cleaning reusable blades
- Helps prevent cross-contamination
- Patented safety heel inhibits blade tip from contacting handle
- Clean cool white LED illumination
- Low power use ensures long battery life
- Convenient for hospital and EMS use
- Compatible with all conventional ISO system handles
- Individually packaged; non-sterile

CAT#	SIZE	DESCRIPTION	A	B	PK
5-5132-01	1	Infant	90mm	18mm	20
5-5132-02	2	Child	100mm	20mm	20
5-5132-03	3	Medium Adult	135mm	21mm	20
5-5132-04	4	Large Adult	155mm	23mm	20

Conventional Laryngoscope
LED STANDARD/D MILLER

LATEX FREE | SINGLE PATIENT USE | DISPOSABLE



- Non-plastic, stainless steel single-use blade
- Eliminates the cost associated with cleaning reusable blades
- Helps prevent cross-contamination
- Patented safety heel inhibits blade tip from contacting handle
- Clean cool white LED illumination
- Low power use ensures long battery life
- Convenient for hospital and EMS use
- Compatible with all conventional ISO system handles
- Individually packaged; non-sterile

CAT#	SIZE	DESCRIPTION	A	B	PK
5-5133-20	00	Premature	65mm	12mm	20
5-5133-00	0	Newborn	79mm	12mm	20
5-5133-01	1	Infant	105mm	12mm	20
5-5133-02	2	Child	157mm	15mm	20
5-5133-03	3	Medium Adult	200mm	15mm	20
5-5133-04	4	Large Adult	205mm	17mm	20

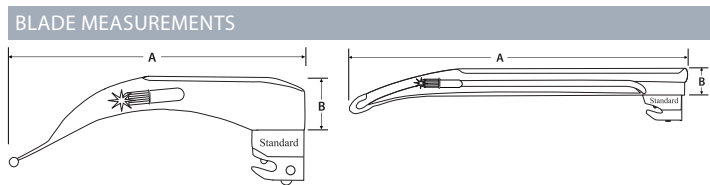

Conventional Laryngoscope

MACINTOSH AMERICAN

LATEX FREE | REUSABLE



- Macintosh laryngoscope design is predominant choice among curved blades
- Smooth gentle spatula curve extends from the lock to the beak of the blade to indirectly raise the epiglottis effectively
- Blade design resembles that of a reverse Z-flange, facilitating greater access during intubation
- Frosted lamp and LED illumination available
- Frosted lamp provides defused illumination minus shadows
- LED lamp provides cool white illumination delivering 35,000 hours of use
- Constructed of 303/304 surgical stainless steel



FROSTED HALOGEN ILLUMINATION

CAT#	SIZE	DESCRIPTION	A	B	PK
5-5052-00	0	Neonate	80mm	15mm	1
5-5052-01	1	Infant	87mm	15mm	1
5-5052-02	2	Child	108mm	15mm	1
5-5052-03	3	Medium Adult	128mm	24mm	1
5-5052-35	3.5	Ext. Med. Adult	144mm	22mm	1
5-5052-04	4	Large Adult	159mm	22mm	1
5-0234-01	-	Replacement Lamp for Sizes 0, 1, 2			10
5-0234-04	-	Replacement Lamp for Sizes 3, 3.5, 4			10

LED ILLUMINATION

CAT#	SIZE	DESCRIPTION	A	B	PK
5-5852-00	0	Neonate	80mm	15mm	1
5-5852-01	1	Infant	87mm	15mm	1
5-5852-02	2	Child	108mm	15mm	1
5-5852-03	3	Medium Adult	128mm	24mm	1
5-5852-35	3.5	Ext. Med. Adult	144mm	22mm	1
5-5852-04	4	Large Adult	159mm	22mm	1
5-0234-21	-	Replacement Lamp for Sizes 0, 1, 2			1
5-0234-24	-	Replacement Lamp for Sizes 3, 3.5, 4			1

WATERPROOF

CAT#	SIZE	DESCRIPTION	A	B	PK
5-5401-00	0	Neonate	80mm	15mm	1
5-5401-01	1	Infant	87mm	15mm	1
5-5401-02	2	Child	108mm	15mm	1
5-5401-03	3	Medium Adult	128mm	24mm	1
5-5401-35	3.5	Ext. Med. Adult	144mm	22mm	1
5-5401-04	4	Large Adult	159mm	22mm	1
5-0234-01	-	Replacement Lamp for Sizes 0, 1, 2			10
5-0234-04	-	Replacement Lamp for Sizes 3, 3.5, 4			10



Conventional Laryngoscope

SIKER MIRROR AMERICAN

LATEX FREE | REUSABLE



- Ideal for use on patients with anatomical variations which make intubation with conventional blades difficult or impossible
- The basic portions of the blade make an angle of 135° with a mirror located at flange angle facing spatula for better visualization
- Distal portion is 3"
- Mirror inverts the reflected image – clinician should exercise caution until familiar with its use
- Curved stylette is recommended for use with the Siker blade
- Immersing blade in warm water bath for 10 minutes prior to use will prevent mirror fogging
- Frosted lamp provides defused illumination without shadows
- Constructed of 303/304 surgical stainless steel

CAT#	SIZE	DESCRIPTION	A	B	PK
5-3075-04	4	Large Adult	158mm	18mm	1
5-0234-04	-	Replacement Lamp			10

Conventional Laryngoscope

IMPROVED VIEW AMERICAN

LATEX FREE | REUSABLE

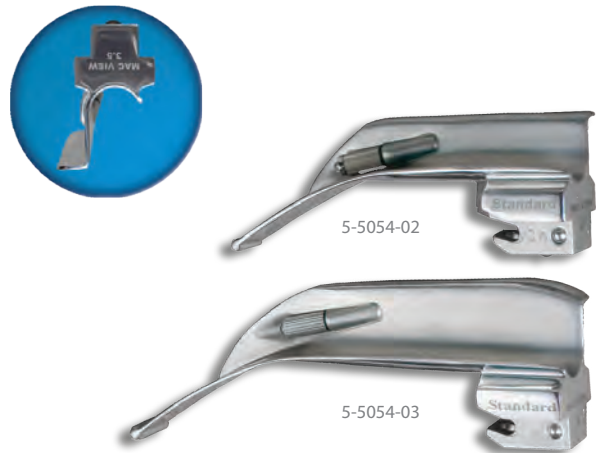

- Channel extends from heel to mid-blade for improved visualization of the cords
- Channel design helps guide endotracheal tube insertion
- Clear reflector lamp delivers four times brighter illumination than frosted lamp
- Constructed of 303/304 surgical stainless steel

CAT#	SIZE	DESCRIPTION	A	B	PK
5-5054-02	2	Child	100mm	18mm	1
5-5054-03	3	Medium Adult	130mm	24mm	1
5-5054-35	3.5	Ext. Med. Adult	144mm	25mm	1
5-5054-04	4	Ext. Lg. Adult	155mm	26mm	1
5-0234-14	-	Replacement Lamp			10

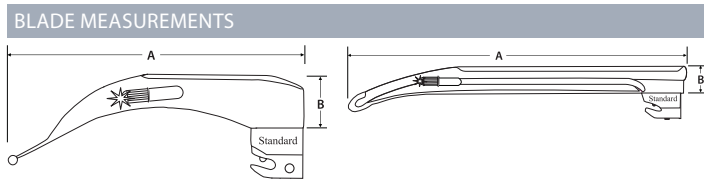

Conventional Laryngoscope
FLANGE-LESS AMERICAN

LATEX FREE | REUSABLE

SunMed

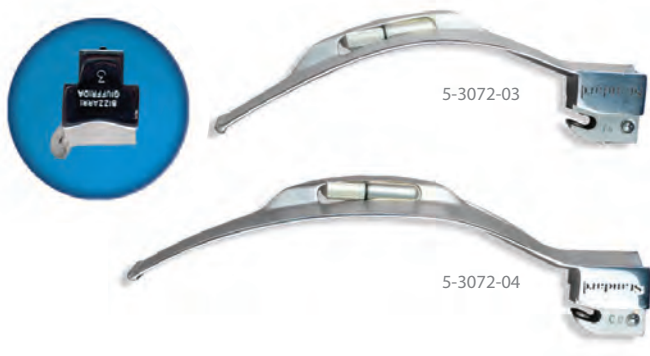

- Bizzarri-Giuffrida
- Absent upper flange on curved blade is effective for use on patients with limited mouth opening, prominent incisors, receding mandible, short thick neck, or larynx in an extreme anterior anatomical position
- Design greatly reduces the potential trauma during laryngoscopy
- Frosted lamp provides defused illumination without shadows
- Constructed of 303/304 surgical stainless steel

CAT#	SIZE	DESCRIPTION	A	B	PK
5-3072-03	3	Medium Adult	130mm	8mm	1
5-3072-04	4	Large Adult	158mm	8mm	1
5-0234-04	-	Replacement Lamp			10

Conventional Laryngoscope
BLECHMAN AMERICAN

LATEX FREE | REUSABLE

SunMed



- Angled tip elevates the epiglottis in supine patient
- Tongue is swept to the left allowing the blade to tip upward for effective viewing from the right side
- Clear lamp provides bright illumination
- Constructed of 303/304 surgical stainless steel

CAT#	SIZE	DESCRIPTION	A	B	PK
5-3084-03	3	Medium Adult	148mm	14mm	1
5-0235-04	-	Replacement Lamp			10

Conventional Laryngoscope
PRISMVIEW AMERICAN

LATEX FREE | REUSABLE

SunMed



- Designed with an optically polished prism with a 30° refraction without image inversion
- Ideal for use when the view of the vocal cords is impaired, especially the most anterior larynx, during nasal intubation, and for post operative examination of the larynx
- Prevent condensation immersing blade in warm water bath for 10 minutes prior to use
- Constructed of 303/304 surgical stainless steel

CAT#	SIZE	DESCRIPTION	A	B	PK
5-5029-02	2	Child	100mm	17mm	1
5-5029-03	3	Medium Adult	130mm	24mm	1
5-5029-35	3.5	Ext. Med. Adult	144mm	25mm	1
5-5029-04	4	Ext. Lg. Adult	155mm	26mm	1
5-0234-14	-	Replacement Lamp			5



Conventional Laryngoscope

MACINTOSH ENGLISH

LATEX FREE | REUSABLE



- Macintosh laryngoscope design is predominant choice among curved blades
- Flange extends all the way down to distal tip
- Soft matte finish virtually eliminates reflection and glare
- Clear lamp and LED illumination available
- Clear lamp provides bright illumination
- Cool white LED illumination delivers 35,000 hours of use; durable performance plus low current use increases battery life
- Constructed of 303/304 surgical stainless steel

CLEAR HALOGEN ILLUMINATION

CAT#	SIZE	DESCRIPTION	A	B	PK
5-5051-00	0	Neonate	80mm	17mm	1
5-5051-01	1	Infant	92mm	14mm	1
5-5051-02	2	Child	100mm	17mm	1
5-5051-03	3	Medium Adult	130mm	18mm	1
5-5051-04	4	Large Adult	155mm	18mm	1
5-5051-05	5	X-Large Adult	175mm	24mm	1
5-0235-01	-	Replacement Lamp for Sizes 0, 1			10
5-0235-04	-	Replacement Lamp for Sizes 2, 3, 4, 5			10

LED ILLUMINATION

CAT#	SIZE	DESCRIPTION	A	B	PK
5-5851-00	0	Neonate	80mm	17mm	1
5-5851-01	1	Infant	92mm	14mm	1
5-5851-02	2	Child	100mm	17mm	1
5-5851-03	3	Medium Adult	130mm	18mm	1
5-5851-04	4	Large Adult	155mm	18mm	1
5-5851-05	5	X-Large Adult	175mm	24mm	1
5-0234-21	-	Replacement Lamp for 0, 1			10
5-0234-24	-	Replacement Lamp for 2, 3, 4, 5			10



LEFT HANDED

CAT#	SIZE	DESCRIPTION	A	B	PK
5-5053-03	3	Med. Adult Left	130mm	18mm	1
5-0235-04	-	Replacement Lamp			10

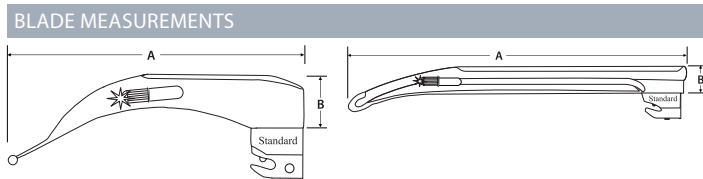

Conventional Laryngoscope
SUNFLEX™ ENGLISH

LATEX FREE | REUSABLE

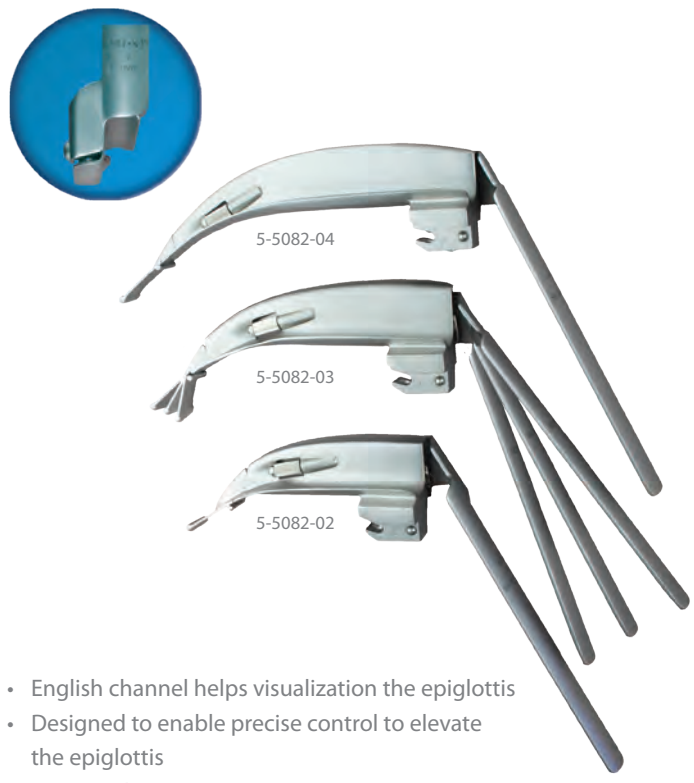

- English channel helps visualization the epiglottis
- Designed to enable precise control to elevate the epiglottis
- Non-pinching tip
- Satin finish virtually eliminates reflection and glare
- Reflector lamp provides extra bright illumination
- Constructed of 303/304 surgical stainless steel

CAT#	SIZE	DESCRIPTION	A	B	PK
5-5082-02	2	Child	102mm	20mm	1
5-5082-03	3	Medium Adult	132mm	25mm	1
5-5082-04	4	Large Adult	155mm	26mm	1
5-0234-14	-	Replacement Lamp			5

Conventional Laryngoscope
PRISMVIEW ENGLISH

LATEX FREE | REUSABLE



- Designed with an optically polished prism with a 30° refraction without image inversion
- Ideal for use when the view of the vocal cords is impaired, especially the most anterior larynx, during nasal intubation, and for post operative examination of the larynx
- Prevent condensation immersing blade in warm water bath for 10 minutes prior to use
- Constructed of 303/304 surgical stainless steel

CAT#	SIZE	DESCRIPTION	A	B	PK
5-5028-02	2	Child	100mm	17mm	1
5-5028-03	3	Medium Adult	130mm	24mm	1
5-5028-35	3.5	Ext. Med. Adult	144mm	25mm	1
5-5028-04	4	Ext. Lg. Adult	155mm	26mm	1
5-0234-14	-	Replacement Lamp			5



Conventional Laryngoscope

REDUCED FLANGE E-MAC™

LATEX FREE | REUSABLE

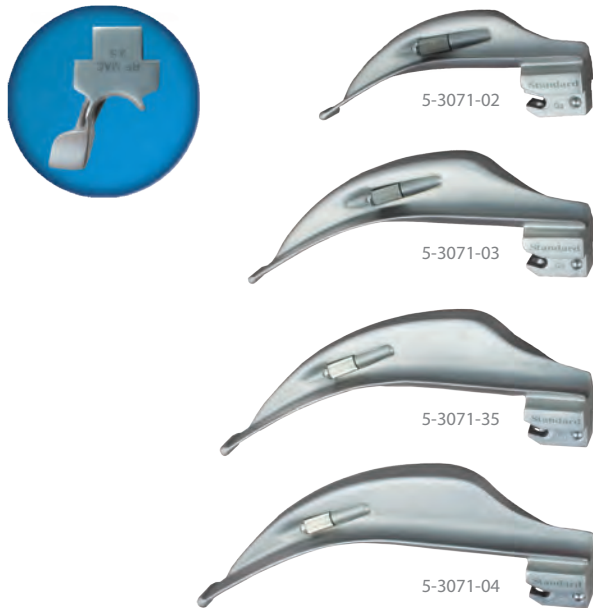

- Channel extends from heel to mid-blade for improved visualization of the cords
- Channel design helps guide endotracheal tube insertion
- Clear reflector lamp delivers four times brighter illumination than frosted lamp
- Constructed of 303/304 surgical stainless steel

CAT#	SIZE	DESCRIPTION	A	B	PK
5-3071-02	2	Child	100mm	18mm	1
5-3071-03	3	Medium Adult	130mm	24mm	1
5-3071-35	3.5	Ext. Med. Adult	145mm	25mm	1
5-3071-04	4	Ext. Lg. Adult	155mm	26mm	1
5-0234-14	-	Replacement Lamp			5

Conventional Laryngoscope

IMPROVED VIEW ENGLISH

LATEX FREE | REUSABLE

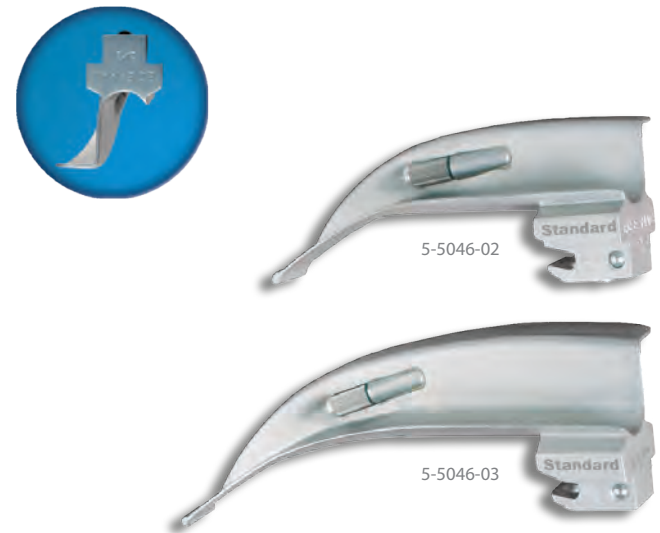

- Channel extends from heel to mid-blade for improved visualization of the cords
- Channel design helps guide endotracheal tube insertion
- Clear reflector lamp delivers four times brighter illumination than frosted lamp
- Constructed of 303/304 surgical stainless steel

CAT#	SIZE	DESCRIPTION	A	B	PK
5-5046-02	2	Child	100mm	18mm	1
5-5046-03	3	Medium Adult	130mm	24mm	1
5-5046-35	3.5	Ext. Med. Adult	144mm	25mm	1
5-5046-04	4	Ext. Lg. Adult	155mm	26mm	1
5-0234-14	-	Replacement Lamp			5

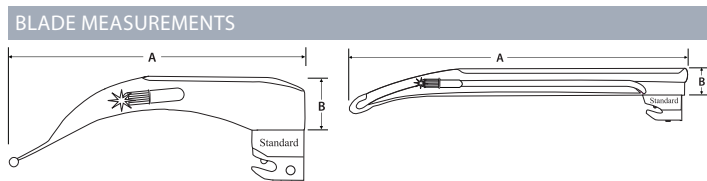

Conventional Laryngoscope
POLIO ENGLISH

LATEX FREE | REUSABLE

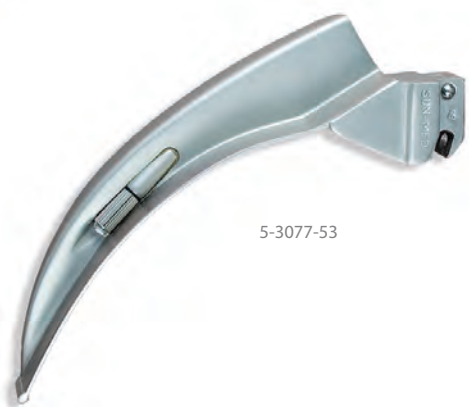

5-3077-53

- Modified Macintosh English profile blade for indirect laryngoscopy
- Blade is offset from handle at an obtuse angle to allow intubation of patients on respirators, in body jackets, as well as other difficult intubation scenarios
- Frosted lamp provides defused illumination without shadows
- Constructed of 303/304 surgical stainless steel

Conventional Laryngoscope
INTUBATION KIT

LATEX FREE

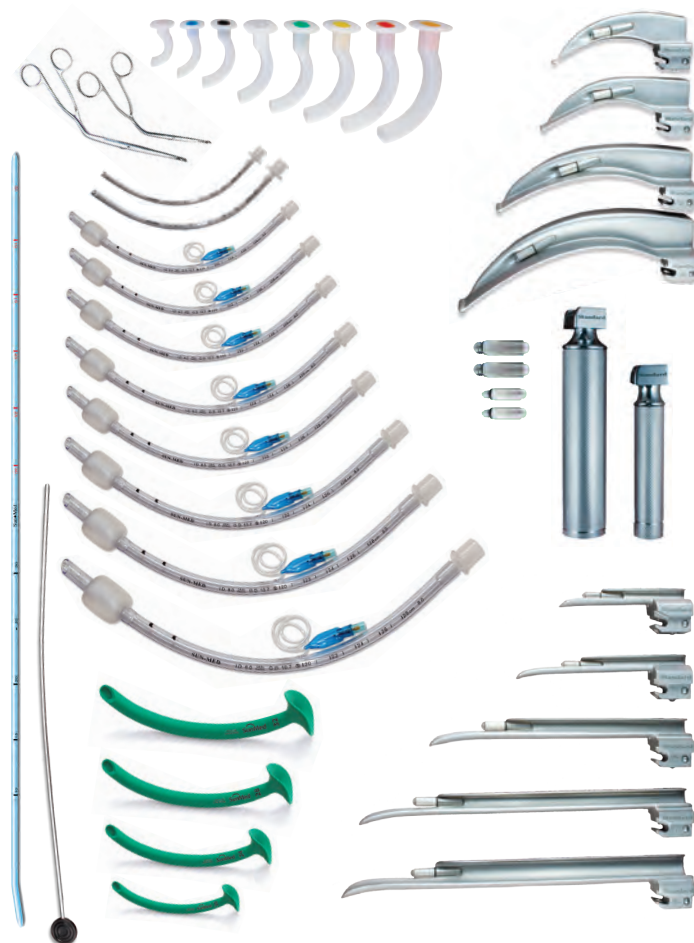

8-1050-85 Conventional Intubation Kit
Batteries, lubricating jelly, and syringe not shown.

CAT#	SIZE	DESCRIPTION	A	B	PK
5-3077-53	3	Medium Adult Angled at 120°	130mm	24mm	1
5-0235-04	-	Replacement Lamp			10

CAT#	KIT INCLUDES	PK
8-1050-85	Conventional Intubation Kit Includes items above + Conventional Laryngoscope Blades	1 Kit
8-1050-80	Nylon Case Only	1



Conventional Laryngoscope
MILLER AMERICAN

LATEX FREE | REUSABLE



- Miller laryngoscope design is predominant choice among straight blades
- Reduced flange helps minimize trauma
- Distal end curve improves lifting of epiglottis
- Designed to facilitate greater exposure of larynx
- Blade sizes 2, 3, and 4 have lamps on right side
- Frosted lamp and LED illumination available
- Frosted lamp provides defused illumination without shadows
- Cool white LED illumination delivers 35,000 hours of use; durable performance plus low current use increases battery life
- Constructed of 303/304 surgical stainless steel

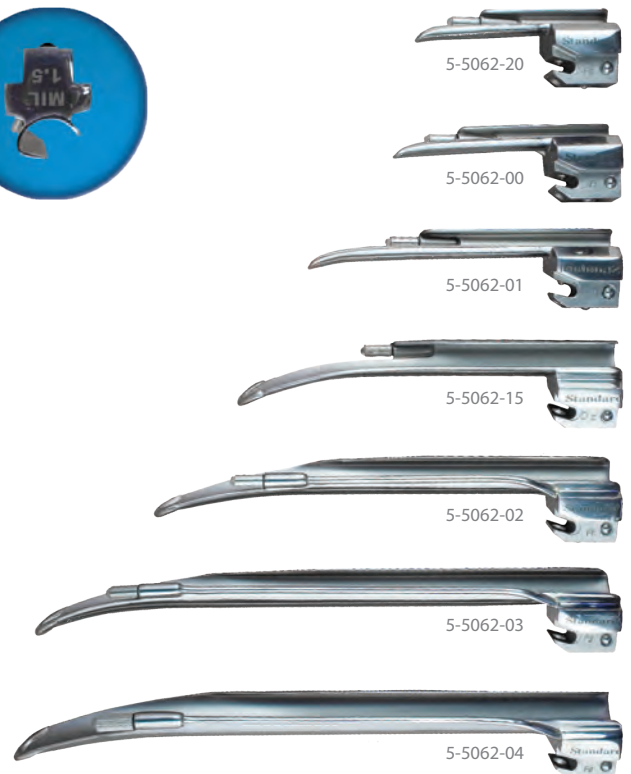

FROSTED HALOGEN ILLUMINATION

CAT#	SIZE	DESCRIPTION	A	B	PK
5-5062-20	00	Premature	65mm	10mm	1
5-5062-00	0	Neonate	75mm	10mm	1
5-5062-01	1	Infant	102mm	10mm	1
5-5062-15	1.5	Small Child	130mm	12mm	1
5-5062-02	2	Child	155mm	13mm	1
5-5062-03	3	Medium Adult	195mm	13mm	1
5-5062-04	4	Large Adult	205mm	14mm	1
5-0234-01	-	Replacement Lamp for Sizes 00, 0, 1, 1.5, 2			10
5-0234-04	-	Replacement Lamp for Sizes 3, 4			10

LED ILLUMINATION

CAT#	SIZE	DESCRIPTION	A	B	PK
5-5862-20	00	Premature	65mm	10mm	1
5-5862-00	0	Neonate	75mm	10mm	1
5-5862-01	1	Infant	102mm	10mm	1
5-5862-15	1.5	Small Child	130mm	12mm	1
5-5862-02	2	Child	155mm	13mm	1
5-5862-03	3	Medium Adult	195mm	13mm	1
5-5862-04	4	Large Adult	205mm	14mm	1
5-0234-21	-	Replacement Lamp for Sizes 00, 0, 1, 1.5, 2			1
5-0234-24	-	Replacement Lamp for Sizes 3, 4			1

WATERPROOF

CAT#	SIZE	DESCRIPTION	A	B	PK
5-5403-20	00	Premature	65mm	10mm	1
5-5403-00	0	Neonate	75mm	10mm	1
5-5403-01	1	Infant	102mm	10mm	1
5-5403-15	1.5	Small Child	130mm	12mm	1
5-5403-02	2	Child	155mm	13mm	1
5-5403-03	3	Medium Adult	195mm	13mm	1
5-5403-04	4	Large Adult	205mm	14mm	1
5-0234-01	-	Replacement Lamp for Sizes 00, 0, 1, 1.5, 2			10
5-0234-04	-	Replacement Lamp for Sizes 3, 4			10



Conventional Laryngoscope
SNOW AMERICAN

LATEX FREE | REUSABLE



5-3069-03

- Combined Miller spatula and the Wis-Foregger flange design can reduce trauma during intubation, especially for use with a cuffed tube
- Curves back from the distal end for a convenient visual field
- Frosted lamp provides defused illumination without shadows
- Constructed of 303/304 surgical stainless steel

CAT#	SIZE	DESCRIPTION	A	B	PK
5-3069-03	3	Medium Adult	162mm	16mm	1
5-0234-04	-	Replacement Lamp			10

Conventional Laryngoscope
CRANWALL AMERICAN

LATEX FREE | REUSABLE



5-5063-00



5-5063-01



5-5063-02



5-5063-03

- Reduced flange allows easier insertion through a restricted opening, such as arthritic jaw or facial burns
- Design helps decrease potential damage to upper teeth
- Flange removed directly below the light carrier
- Can easily be used as a left-handed straight blade
- Frosted lamp provides defused illumination without shadows
- Constructed of 303/304 surgical stainless steel

CAT#	SIZE	DESCRIPTION	A	B	PK
5-5063-00	0	Neonate	75mm	6mm	1
5-5063-01	1	Infant	100mm	6mm	1
5-5063-02	2	Child	157mm	8mm	1
5-5063-03	3	Medium Adult	195mm	9mm	1
5-0234-01	-	Replacement Lamp for Sizes 0, 1, 2			10
5-0234-04	-	Replacement Lamp for Size 3			10

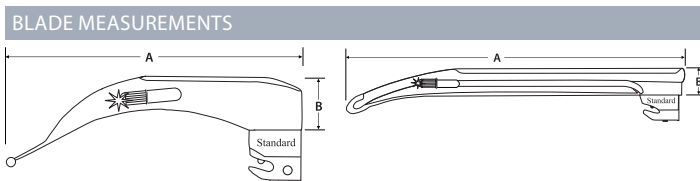

Conventional Laryngoscope
PHILLIPS AMERICAN

LATEX FREE | REUSABLE

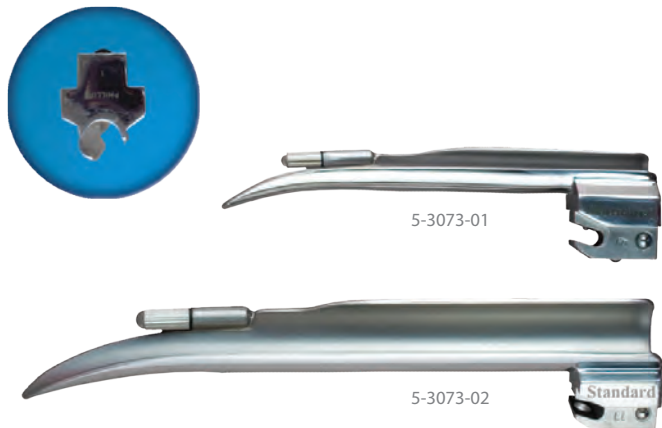

- Combines the straight Jackson blade design with the curved distal tip Miller design to allow greater visibility and a 'direct line' approach to the trachea
- Low profile flange reduces the risks of oral damage
- Unique lamp mounting enables deep illumination both downward and inward
- Frosted lamp provides defused illumination without shadows
- Constructed of 303/304 surgical stainless steel

CAT#	SIZE	DESCRIPTION	A	B	PK
5-3073-01	1	Child	113mm	13mm	1
5-3073-02	2	Adult	166mm	18mm	1
5-0234-01	-	Replacement Lamp			10

Conventional Laryngoscope
WISCONSIN AMERICAN

LATEX FREE | REUSABLE

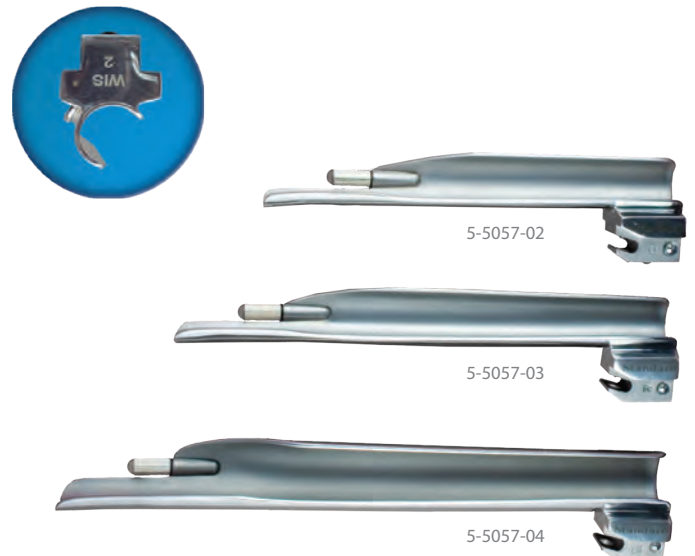

- Straight spatula design with flange that expands slightly toward the distal portion of the blade increases visual field helping to prevent potential trauma during intubation
- Distal portion of the blade is wider and formed slightly to the right, making it well-adapted to lifting the epiglottis
- Frosted lamp provides defused illumination without shadows
- Constructed of 303/304 surgical stainless steel

CAT#	SIZE	DESCRIPTION	A	B	PK
5-5057-02	2	Child	135mm	17mm	1
5-5057-03	3	Medium Adult	162mm	18mm	1
5-5057-04	4	Large Adult	199mm	21mm	1
5-0234-04	-	Replacement Lamp			10

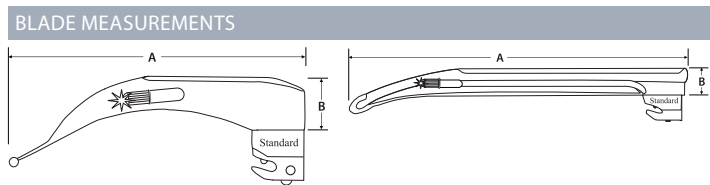

Conventional Laryngoscope

WIS-HIPPLE AMERICAN

LATEX FREE | REUSABLE

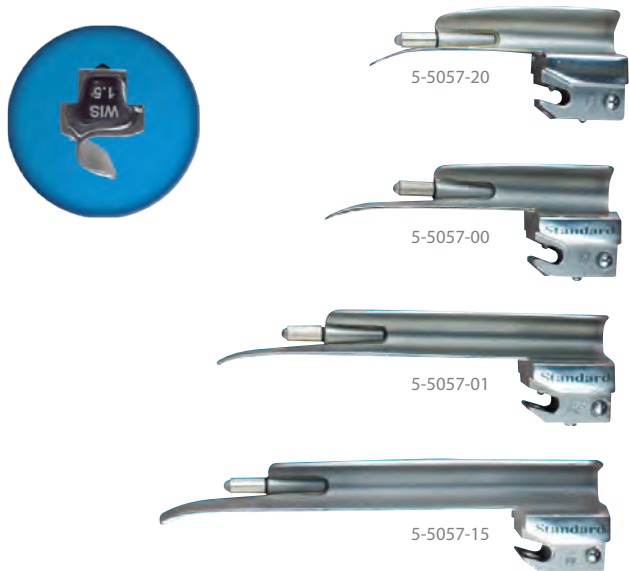

- Wisconsin-modified blade with a straight spatula
- Flange tends to be straighter than a Wisconsin blade and runs parallel with the spatula
- Designed primarily for use in infants
- Wider, flat tip is well-adapted to lifting the epiglottis
- Frosted lamp provides defused illumination without shadows
- Constructed of 303/304 surgical stainless steel

CAT#	SIZE	DESCRIPTION	A	B	PK
5-5057-20	00	Premature	65mm	11mm	1
5-5057-00	0	Newborn	76mm	12mm	1
5-5057-01	1	Infant	102mm	13mm	1
5-5057-15	1.5	Small Child	115mm	14mm	1
5-0234-01	-	Replacement Lamp			10

Conventional Laryngoscope

MILLER PORT AMERICAN

LATEX FREE | REUSABLE



- Specifically designed to perform laryngoscopy and intubation with reduced risk of hypoxia
- Integrated tube permits delivery of oxygen or other gas mixtures during intubation
- Frosted lamp provides defused illumination without shadows
- Constructed of 303/304 surgical stainless steel

CAT#	SIZE	DESCRIPTION	A	B	PK
5-3078-00	0	Newborn	75mm	10mm	1
5-3078-01	1	Infant	102mm	10mm	1
5-0234-01	-	Replacement Lamp			10

Conventional Laryngoscope

SCHAPIRA AMERICAN

LATEX FREE | REUSABLE

SunMed



5-3080-04

- Absent flange helps reduce the risk of trauma to the patient while providing excellent visualization
- Frosted lamp provides defused illumination without shadows
- Constructed of 303/304 surgical stainless steel

Conventional Laryngoscope

WHITEHEAD AMERICAN

LATEX FREE | REUSABLE

SunMed



5-3065-03

- Reduced flange design increases visualization and facilitates intubation
- Helps prevent potential damage to the incisors
- Frosted lamp provides defused illumination without shadows
- Constructed of 303/304 surgical stainless steel

CAT#	SIZE	DESCRIPTION	A	B	PK
5-3080-04	4	Large Adult	177mm	7mm	1
5-0234-04	-	Replacement Lamp			10

CAT#	SIZE	DESCRIPTION	A	B	PK
5-3065-03	3	Medium Adult	162mm	13mm	1
5-0234-04	-	Replacement Lamp			10

BLADE MEASUREMENTS

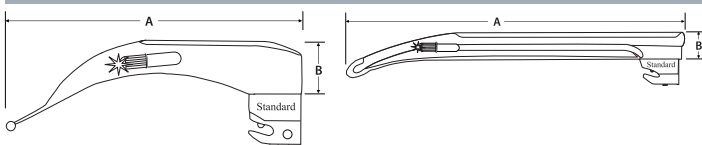

Conventional Laryngoscope
MILLER ENGLISH

LATEX FREE | REUSABLE

SunMed



Conventional Laryngoscope
OXFORD ENGLISH

LATEX FREE | REUSABLE

SunMed

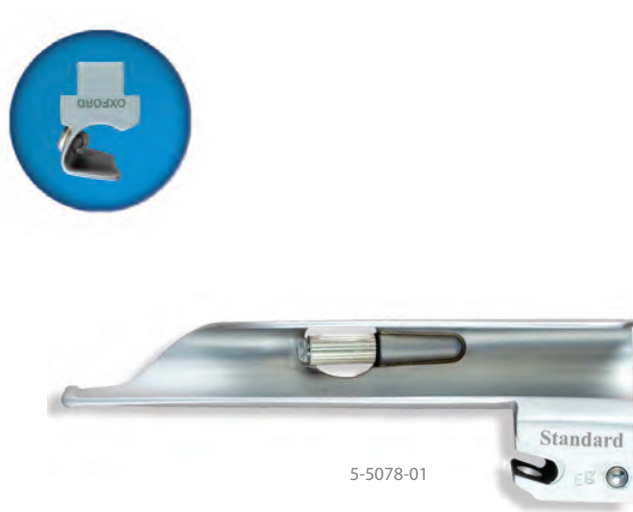

- Miller laryngoscope design is predominant choice among straight blades
- Satin finish virtually eliminates reflection and glare
- Halogen and LED illumination available
- Clear halogen provides bright illumination
- Cool white LED illumination delivers 35,000 hours of use; durable performance plus low current use increases battery life
- Constructed of 303/304 surgical stainless steel

- Suitable for premature infants, babies and young children up to the age of four.
- Overhang on the open side prevents lips from obscuring vision
- Broad, flat surface aids pediatric patients with extreme cleft palates
- Clear lamp provides bright illumination
- Constructed of 303/304 surgical stainless steel

CLEAR HALOGEN ILLUMINATION

CAT#	SIZE	DESCRIPTION	A	B	PK
5-5061-00	0	Neonate	77mm	9mm	1
5-5061-01	1	Infant	102mm	9mm	1
5-5061-02	2	Child	153mm	11mm	1
5-5061-03	3	Medium Adult	195mm	11mm	1
5-5061-04	4	Large Adult	205mm	16mm	1
5-0235-01	-	Replacement Lamp for Sizes 0, 1			10
5-0235-04	-	Replacement Lamp for Sizes 2, 3, 4			10

CAT#	SIZE	DESCRIPTION	A	B	PK
5-5078-01	1	Infant	102mm	12mm	1
5-0235-01	-	Replacement Lamp			10

LED ILLUMINATION

CAT#	SIZE	DESCRIPTION	A	B	PK
5-5861-00	0	Neonate	77mm	9mm	1
5-5861-01	1	Infant	102mm	9mm	1
5-5861-02	2	Child	153mm	11mm	1
5-5861-03	3	Medium Adult	195mm	11mm	1
5-5861-04	4	Large Adult	205mm	16mm	1
5-0234-21	-	Replacement Lamp for Sizes 0, 1			1
5-0234-24	-	Replacement Lamp for Sizes 2, 3, 4			1



FOR COMPLETE
Customer Service
Technical Information
Care/Cleaning Instructions
Product Literature

CALL
800-433-2797

VISIT
www.Sun-Med.com

EMAIL
info@Sun-Med.com



Conventional Laryngoscope
GUEDEL ENGLISH

LATEX FREE | REUSABLE



- 28° angled blade helps promote lifting without using the teeth as a fulcrum
- Designed specifically for use with cuffed endotracheal tubes
- Distal tip is angled slightly more than the Flagg to assist in epiglottis compression
- Frosted lamp provides defused illumination without shadows
- Constructed of 303/304 surgical stainless steel

CAT#	SIZE	DESCRIPTION	A	B	PK
5-3055-01	1	Infant	97mm	13mm	1
5-3055-02	2	Child	122mm	13mm	1
5-3055-03	3	Medium Adult	137mm	16mm	1
5-3055-04	4	Large Adult	162mm	17mm	1
5-0234-01	-	Replacement Lamp for Sizes 1, 2			10
5-0234-04	-	Replacement Lamp for Sizes 3, 4			10

Conventional Laryngoscope
ROBERTSHAW ENGLISH

LATEX FREE | REUSABLE

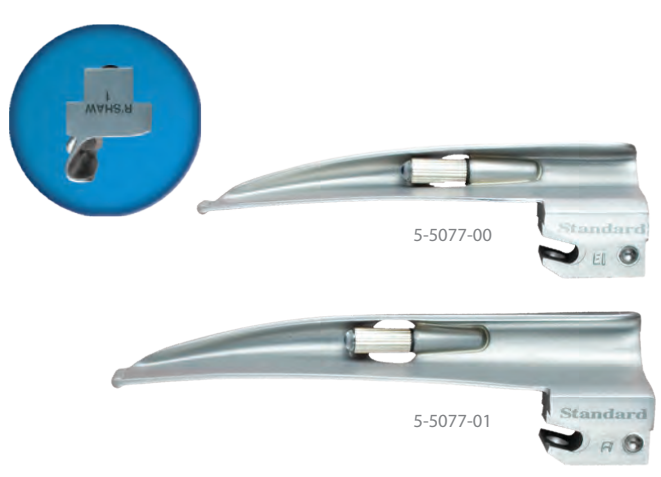

- Designed specifically for infants and children
- Spatula is gently curved over the distal third and can indirectly lift the epiglottis similar to a Macintosh blade
- Permits binocular vision allowing better judgment of depth and consequently less risk of trauma
- Clear lamp provides bright illumination
- Constructed of 303/304 surgical stainless steel

CAT#	SIZE	DESCRIPTION	A	B	PK
5-5077-00	0	Newborn	94mm	10mm	1
5-5077-01	1	Infant	112mm	12mm	1
5-0235-01	-	Replacement Lamp			1

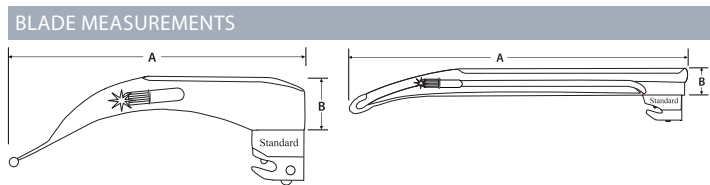

Conventional Laryngoscope
SEWARD ENGLISH

LATEX FREE | REUSABLE

SunMed



- Originally produced as an infant blade for use in asphyxia neonatorum, it is now available to fit older children
- Clear lamp provides bright illumination
- Constructed of 303/304 surgical stainless steel

CAT#	SIZE	DESCRIPTION	A	B	PK
5-5079-01	1	Infant	105mm	7mm	1
5-5079-02	2	Child	130mm	13mm	1
5-0235-01	-	Replacement Lamp			10

Conventional Laryngoscope
SOPER ENGLISH

LATEX FREE | REUSABLE

SunMed



- Broad flat blade makes it easier to restrict premature and newborn infant tongue movement
- Clear lamp provides bright illumination
- Constructed of 303/304 surgical stainless steel

CAT#	SIZE	DESCRIPTION	A	B	PK
5-5080-01	1	Infant	100mm	10mm	1
5-0235-01	-	Replacement Lamp			10



Conventional Laryngoscope

LARYNGOSCOPE KITS

LATEX FREE | REUSABLE

SunMed

- Available in Macintosh and Miller, American and English profiles
- Blades constructed of 303/304 surgical stainless steel
- High impact plastic case - for ease of transport
- Include most popular laryngoscope blades and replacement lamps
- Include chrome plated handle



MACINTOSH AMERICAN PROFILE

CAT#	KIT INCLUDES	PK
5-5052-44	Medium Handle (5-0237-03), Macintosh Blades: 1 (5-5052-01), 2 (5-5052-02), 3 (5-5052-03), 4 (5-5052-04), 2 Replacement Lamps (5-0234-01, 5-0234-04), Case (8-1050-73)	1 Kit



MACINTOSH ENGLISH PROFILE

CAT#	KIT INCLUDES	PK
5-5051-44	Medium Handle (5-0237-03), Macintosh Blades: 1 (5-5051-01), 2 (5-5051-02), 3 (5-5051-03), 4 (5-5051-04), 2 Replacement Lamps (5-0235-01, 5-0235-04), Case (8-1050-73)	1 Kit



MILLER ENGLISH PROFILE

CAT#	KIT INCLUDES	PK
5-5061-45	Medium Handle (5-0237-03), Miller Blades: 0 (5-5061-00), 1 (5-5061-01), 2 (5-5061-02), 3 (5-5061-03), 4 (5-5061-04), 2 Replacement Lamps (5-0235-01, 5-0235-04), Case (8-1050-71)	1 Kit





MILLER AMERICAN PROFILE

CAT#	KIT INCLUDES	PK
5-5062-45	Medium Handle (5-0237-03), Miller Blades: 0 (5-5062-00), 1 (5-5062-01), 2 (5-5062-02), 3 (5-5062-03), 4 (5-5062-04), 2 Replacement Lamps (5-0234-01, 5-0234-04), Case (8-1050-71)	1 Kit



MACINTOSH/MILLER AMERICAN PROFILE

CAT#	KIT INCLUDES	PK
5-5062-47	Medium Handle (5-0237-03), Macintosh Blades: 2 (5-5052-02), 3 (5-5052-03), 4 (5-5052-04), Miller Blades: 0 (5-5062-00), 1 (5-5062-01), 2 (5-5062-02), 3 (5-5062-03), 2 Replacement Lamps (5-0234-01, 5-0234-04), Case (8-1050-77)	1 Kit



MACINTOSH/MILLER ENGLISH PROFILE

CAT#	KIT INCLUDES	PK
5-5061-47	Medium Handle (5-0237-03), Macintosh Blades: 2 (5-5051-02), 3 (5-5051-03), 4 (5-5051-04) Miller Blades: 0 (5-5061-00), 1 (5-5061-01), 2 (5-5061-02), 3 (5-5061-03), 2 Replacement Lamps (5-0235-01, 5-0235-04), Case (8-1050-77)	1 Kit



SUNFLEX

CAT#	KIT INCLUDES	PK
5-5082-42	Medium Handle (5-0237-03), SunFlex Blades: 3 (5-5082-03), 4 (5-5082-04), Replacement Lamp (5-0234-14), Case (8-1050-72)	1 Kit
8-1050-72	SunFlex Blade Case Only	



Conventional Laryngoscope
CHROME PLATED

LATEX FREE | REUSABLE



Conventional Laryngoscope
STAINLESS STEEL WATERPROOF

LATEX FREE | REUSABLE



- Chrome plated brass
- Batteries are not included

- Stainless steel waterproof handles may be immersed in disinfectant without removing batteries
- Batteries are not included

CAT#	SIZE	DESCRIPTION	BATTERIES	PK
5-0237-01	Penlite	Chrome Plated Brass	2 "AA"	1
5-0237-02	Stubby	Chrome Plated Brass	2 "AA"	1
5-0237-03	Medium	Chrome Plated Brass	2 "C"	1
5-0237-05	Large	Chrome Plated Brass	2 "D"	1
5-0237-08	Mini	Chrome Plated Brass	Lith 123	1

CAT#	SIZE	DESCRIPTION	BATTERIES	PK
5-0237-91	Penlite	Waterproof Handle	2 "AA"	1
5-0237-92	Stubby	Waterproof Handle	2 "AA"	1
5-0237-93	Medium	Waterproof Handle	2 "C"	1
5-0237-96	Micro	Waterproof Handle	Lith 123	1



Conventional Laryngoscope
HOWLAND LOCK

LATEX FREE | REUSABLE

SunMed



- Natural lifting simplifies laryngeal exposure, making intubation possible even in the most difficult cases
- Built-in leverage decreases prying and reduces possibility of broken teeth
- Compatible with all hook-on conventional laryngoscope handles and blades
- Can often make an otherwise certain tracheotomy unnecessary

CAT#	DESCRIPTION	PK
5-0236-00	Conventional Howland Lock	1

Conventional Laryngoscope
DISPOSABLE LARYNGOSCOPE KIT

LATEX FREE | SINGLE PATIENT USE | DISPOSABLE

SunMed



CAT#	KIT INCLUDES	PK
5-5133-57	Medium Handle (5-0237-03) Macintosh Blades: 2 (5-5132-02), 3 (5-5132-03), 4 (5-5132-04), Miller Blades: 0 (5-5133-00), 1 (5-5133-01), 2 (5-5133-02), 3 (5-5133-03) Canvas Pouch	1

Conventional Laryngoscope
REPLACEMENT BLADE LAMPS

LATEX FREE | REUSABLE

SunMed



- For use in conventional blades
- Compatible with all conventional blades
- Meets stringent manufacturing controls
- Frosted lamps provide defused illumination without shadows
- Clear lamps provide bright illumination
- Contact Customer Care for correct lamp selection

CAT#	SIZE	DESCRIPTION	PK
5-0234-01	Small	Frosted Lamp	10
5-0234-04	Large	Frosted Lamp	10
5-0234-14	Large	Reflector Lamp	5
5-0234-21	Small	LED Lamp	1
5-0234-24	Large	LED Lamp	1
5-0235-01	Small	Clear Lamp	10
5-0235-04	Large	Clear Lamp	10



FOR COMPLETE
Customer Service
Technical Information
Care/Cleaning Instructions
Product Literature

CALL
800-433-2797

VISIT
www.Sun-Med.com

EMAIL
info@Sun-Med.com



Conventional Laryngoscope
INTUBATION KIT

LATEX FRE

SunMed

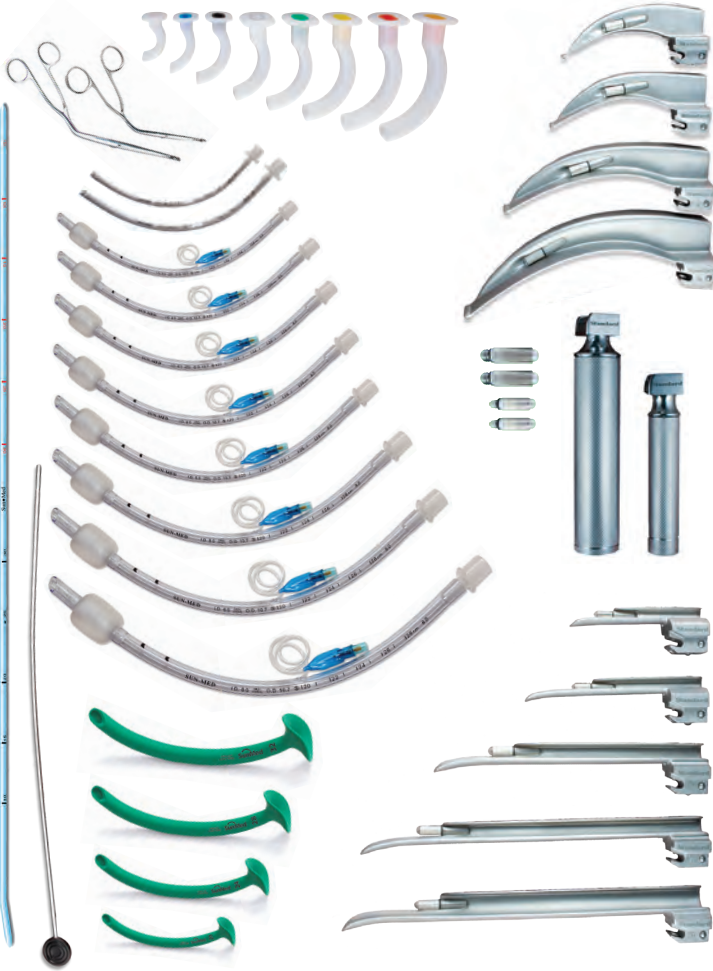

8-1050-85 Conventional Intubation Kit
Batteries, lubricating jelly, and syringe not shown.

Complete intubation kits available with conventional, fiber optic or fiber optic disposable laryngoscope blades

Each kit includes:

- 8 Oropharyngeal color coded Guedel airways (sizes 40mm-100mm)
- 1 Penlite chrome plated fiber optic laryngoscope handle
- 1 Medium chrome plated fiber optic laryngoscope handle
- 5 Miller laryngoscope blades (sizes 0-4)
- 4 Macintosh laryngoscope blades (sizes 1-4)
- 4 Extra laryngoscope lamps (2 small, 2 large)
- 1 Adult Magill forceps
- 1 Pediatric Magill forceps
- 2 "C" batteries
- 2 "AA" batteries
- 4 Packets of sterile lubricating jelly
- 2 Endotracheal uncuffed tubes (sizes 2.5, 4mm)
- 8 Endotracheal cuffed tubes (sizes 5-10mm)
- 4 Nasopharyngeal airways (sizes 20, 24, 28, 32Fr)
- 1 10ml syringe
- 1 Endotracheal tube introducer (bougie) with coude tip
- 1 Adult stylette
- 1 Nylon airway management case

CAT#	KIT INCLUDES	PK
8-1050-85	Conventional Intubation Kit Includes items above + Conventional Laryngoscope Blades	1 Kit
8-1050-80	Nylon Case Only	1



Inflatable Anesthesia Mask

VENT MASK

LATEX FREE | SINGLE PATIENT USE | DISPOSABLE



- Premium soft cushioned mask
- Pliable, ultra-thin wall
- Low-pressure soft seal with superior seating characteristics

CAT#	SIZE	DESCRIPTION	PK
VR1100	Small Infant	Vent Mask	20, 40
VR2100	Infant	Vent Mask	20, 40
VR3100	Small Child	Vent Mask	20, 40
VR4100	Child	Vent Mask	20, 40
VR5000	Wide Adult	Vent Mask	20, 50, 100
VR5100	Adult	Vent Mask	20, 50, 100
VR6100	Large Adult	Vent Mask	20, 50, 100

Inflatable Anesthesia Mask

SOFTAIRE

LATEX FREE | SINGLE PATIENT USE | DISPOSABLE



- Inflatable, soft cushioned mask
- Superior patient comfort
- Effective seal and seating

CAT#	SIZE	DESCRIPTION	PK
VR1700	Small Infant	Soft Aire Mask	20, 40
VR2700	Infant	Soft Aire Mask	20, 40
VR3700	Small Child	Soft Aire Mask	20, 40
VR4700	Child	Soft Aire Mask	20, 40
VR5700	Adult	Soft Aire Mask	20, 50, 100
VR6700	Wide Adult	Soft Aire Mask	20, 50, 100
VR7700	XLg Adult Wide	Soft Aire Mask	20, 50, 100



Inflatable Mask
FLEXIBLE

LATEX FREE | SINGLE PATIENT USE | DISPOSABLE

SunMed



- Reduces wasted anesthetic gas pollution
- Transparent housing for immediate detection of regurgitation or silent aspiration
- Removable color coded hook ring

CAT#	SIZE	DESCRIPTION	COLOR	PK
4-0110-00	Neonate	Inflatable	Gray	30
4-0110-01	Infant	Inflatable	Light Blue	30
4-0110-02	Child	Inflatable	Yellow	30
4-0110-03	Small Adult	Inflatable	Green	30
4-0110-04	Med. Adult	Inflatable	Red	30
4-0110-05	Large Adult	Inflatable	Dark Blue	30

Accessory
MASK HARNESS

LATEX FREE | REUSABLE

SunMed



- Molded, not stamped
- Reinforced holes on adult size for extra durability
- Neoprene
- Center vents for comfort and fit at back of head

CAT#	SIZE	DESCRIPTION	PK
4-1054-21	Infant, 13" x 2.5"	Mask Harness	1
4-1054-22	Child, 22" x 4"	Mask Harness	1
4-1054-23	Adult, 27" x 5.5"	Mask Harness	1



Non-Inflatable Anesthesia Mask

VENT MASK II

LATEX FREE | SINGLE PATIENT USE | DISPOSABLE

Ventlab



- Air-filled, soft cushioned mask
- Pliable, ultra-thin wall
- Low-pressure soft seal with superior seating characteristics

CAT#	SIZE	DESCRIPTION	PK
VR0040	XSmall Neonate	Vent Mask II	20, 40
VR0400	Small Neonate	Vent Mask II	20, 40
VR1400	Small Infant	Vent Mask II	20, 40
VR2400	Infant	Vent Mask II	20, 40
VR3400	Small Child	Vent Mask II	20, 40
VR4400	Child	Vent Mask II	20, 40
VR5400	Adult	Vent Mask II	20, 50, 100
VR6400	Large Adult	Vent Mask II	20, 50, 100

Non-Inflatable Anesthesia Mask

SOFT SEAL

LATEX FREE | SINGLE PATIENT USE | DISPOSABLE

Ventlab



- Non-inflatable mask
- Pliable cushion
- Economical anesthesia mask

CAT#	SIZE	DESCRIPTION	PK
VR1600	Neonate	Soft Seal Mask	20
VR2600	Infant	Soft Seal Mask	20
VR3600	Child	Soft Seal Mask	20



Medication Delivery

INFU-SURG® PRESSURE INFUSION BAG

LATEX FREE | SINGLE PATIENT USE | DISPOSABLE

Ethox



- Ideal for intravenous and intra-arterial infusion treatment including A-line pressure monitoring
- Pressure relief valve prevents over inflation (330mmHg pressure relief)
- Large, oval shaped bulb allows for quick and easy inflation of bladder
- Single-handed inflation and deflation design makes it easy to use and requires minimal training
- Dedicated fluid bag hook enables efficient loading and unloading of the system without having to remove the infusion bag from the IV pole
- Suitable for use with external inflation sources
- Color-coded gauge makes for accurate pressure monitoring (0-300mmHg)
- Three-way stopcock ensures precise control of pressure
- Incredibly reliable – 100% tested



Three-way stopcock ensures precise control of pressure while the large oval bulb allows for quick bladder inflation, all with ONE hand



Solution bag hook enables easy bag changing without having to remove the Infu-Surg from the IV pole; keeps fluid bag in proper position while in use



360° view of the color-coded gauge facilitates accurate pressure monitoring while the safety pressure relief valve prevents over-inflation

CAT#	VOLUME	DESCRIPTION	PK
4005H	500ml	Infu-Surg® with Hook	25
4010H	1000ml	Infu-Surg® with Hook	25
4030	3000ml	Infu-Surg®	25



Medication Delivery

INFU-SURG® CLARITY™ PRESSURE INFUSION BAG

LATEX FREE | SINGLE PATIENT USE | DISPOSABLE

Ethox



Clear panel enables full visibility of solution bag to monitor fluid level and easily scan patient barcode

- Transparent panel for clear visibility of solution bag
- Ideal for intravenous and intra-arterial infusion treatment including A-line pressure monitoring
- Dedicated hook enables quick change of solution bag while providing proper fluid bag positioning in pocket
- Pressure relief valve prevents over-inflation (330mmHg)
- Color-coded gauge provides accurate pressure monitoring (0-300mmHg)
- Single-handed inflation and deflation with oval-shaped bulb makes it easy to use and requires minimal training
- Welded panel and hook construction are more durable than sewn designs to withstand repeated use
- Suitable for use with external inflation sources
- Three-way stopcock ensures precise control of pressure
- Incredibly reliable – 100% tested



360° view of the color-coded gauge facilitates accurate pressure monitoring while the safety pressure relief valve prevents over-inflation



Solution bag hook enables easy bag changing without having to remove the Infu-Surg from the IV pole; keeps fluid bag in proper position while in use



Three-way stopcock ensures precise control of pressure while the large oval bulb allows for quick bladder inflation, all with ONE hand

CAT#	VOLUME	DESCRIPTION	PK
4050	500ml	Infu-Surg® Clarity	25
4100	1000ml	Infu-Surg® Clarity	25



Medication Delivery

INTEGRITY™ PRESSURE INFUSION

LATEX FREE | SINGLE PATIENT USE | DISPOSABLE

Ventlab



Three-way stopcock ensures precise control of pressure while the large oval bulb allows for quick bladder inflation, all with ONE hand

360° view of the color-coded gauge facilitates accurate pressure monitoring while the safety pressure relief valve prevents over-inflation

- Pressure relief valve prevents over inflation (330mmHg pressure relief)
- Large, oval shaped bulb allows for quick and easy inflation of bladder
- Single-handed inflation and deflation design makes it easy to use and requires minimal training
- Suitable for use with external inflation sources
- Color-coded gauge makes for accurate pressure monitoring (0-300mmHg)
- Three-way stopcock ensures precise control of pressure
- Incredibly reliable – 100% tested

CAT#	VOLUME	DESCRIPTION	PK
VC505	500ml	Integrity Pressure Infusion	25
VC510	1000ml	Integrity Pressure Infusion	25
VC530	3000ml	Integrity Pressure Infusion	25

Medication Delivery

VENTLAB PRESSURE INFUSION

LATEX FREE | SINGLE PATIENT USE | DISPOSABLE

Ventlab



Color-coded dial facilitates accurate pressure monitoring

- Pressure relief valve prevents over inflation (330mmHg pressure relief)
- Large, oval shaped bulb allows for quick and easy inflation of bladder
- Single-handed inflation and deflation design makes it easy to use and requires minimal training
- Color-coded dial gauge makes for accurate pressure monitoring (0-300mmHg)
- Three-way stopcock ensures precise control of pressure
- Economical yet dependable pressure infusion choice

CAT#	VOLUME	DESCRIPTION	PK
VC405	500ml	Pressure Infusion	25
VC410	1000ml	Pressure Infusion	25
VC430	3000ml	Pressure Infusion	25



Patient Safety

IGUARD EYE PROTECTOR

LATEX FREE | STERILE | SINGLE USE | DISPOSABLE

SunMed



- Rigid, clear protective patient eye cover for use in OR, ER, and during general procedures
- Non-allergenic self-adhesive foam cushion for fast and accurate application
- Thick foam for patient comfort even in prone position
- Improved one piece backing with "courtesy tabs"

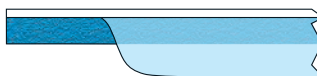

9-0210-00
Standard Foam

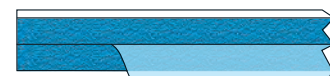

9-0210-20
Double Foam

STERILE

CAT#	DESCRIPTION	PK
9-0210-00	Adult Eye Protector	25
9-0210-21	Pediatric Eye Protector	25
9-0210-20	Double Foam Eye Protector	25

NON-STERILE

CAT#	DESCRIPTION	PK
9-0210-00I	Adult Eye Protector	25
9-0210-21I	Pediatric Eye Protector	25
9-0210-20I	Double Foam Eye Protector	25



FOR COMPLETE
Customer Service
Technical Information
Care/Cleaning Instructions
Product Literature

CALL
800-433-2797

VISIT
www.Sun-Med.com

EMAIL
info@Sun-Med.com



Monoscope

COMFORT FIT SOFTEAR™

LATEX FREE | SINGLE PATIENT USE | DISPOSABLE

SunMed



- Designed specifically to address sound transmission challenges for the anesthesiologist due to the irregular and variable shape of the ear canal
- Once compressed foam earpiece is inserted, it expands slowly for a perfect, low pressure seal with the canal wall
- Sealing action enables the accurate transmission of low volume sounds
- Low pressure fit against ear canal provides maximum comfort, thus promoting more vigilant use
- Connects to esophageal stethoscopes and Wenger (precordial) chest pieces
- 4' Tubing

CAT#	DESCRIPTION	PK
6-1030-25	Comfort FIT SoftEar™ Monoscope	25

Precordial Stethoscope

CHEST PIECES

LATEX FREE

SunMed



- Durable stainless steel construction – no chrome plating to flake or peel
- Pediatric chest pieces are hollow and lightweight, with rounded, smooth chest surface, making them ideal for use with newborns and infants
- Solid Wenger chest pieces feature a relatively deep sound chamber
- All chest pieces have a luer slip male connector
- Reusable

CAT#	DESCRIPTION	SIZE	PK
6-0025-00	Newborn Chest Piece	0.875" Diameter	1
6-0025-01	Infant Chest Piece	1.125" Diameter	1
6-0025-02	Child Chest Piece	1.125" Diameter	1
6-0025-03	Adult Wenger Chest Pc	1.44" Diameter	1

Precordial Stethoscope

PRECORDIAL SET

LATEX FREE | SINGLE PATIENT USE

SunMed

- 1 each adult, child, infant, and newborn chest piece
- 8 Double adhesive disks (Also available separately)
- 1 Comfort FIT SoftEar™ disposable monoscope



CAT#	DESCRIPTION	PK
6-0025-05	Precordial Stethoscope Set	1 Set
6-0025-25	Double Adhesive Disks Only	100



Stethoscope
SPRAGUE

LATEX FREE



Stethoscope
DUAL HEAD

LATEX FREE



- Three different size bells eliminates the need for multiple stethoscopes for infants, children and adults
- Various heads for acoustical responses in low, medium and high pitch sounds
- Heavy wall 22" tubing and choice of ear tips help reduce sound leakage and extraneous noise
- Complete stethoscope kit includes 1 pair black plastic ear tips, 3 open bells (infant, child, adult), 1 pair soft rubber (mushroom type) ear tips, adult and pediatric diaphragms
- 29" Overall length

- Molded one piece Y tubing
- High sensitivity - lightweight diaphragm
- Non-chill ring
- Anodized aluminum chestpiece
- Chrome plated brass binaurals
- White plastic ear tips
- Superior acoustics
- 31" Overall length

CAT#	DESCRIPTION	PK
6-0028-00	Sprague Rappaport Stethoscope	1

CAT#	DESCRIPTION	COLOR	PK
6-0027-40	Dual Head Stethoscope	Black	1
6-0027-41	Dual Head Stethoscope	Red	1
6-0027-42	Dual Head Stethoscope	Grey	1
6-0027-43	Dual Head Stethoscope	Green	1



RESPIRATORY



- 102-107 Cannulas
- 108-109 Masks
- 111 Circuits
- 103 Respiratory Devices
- 118-120 Breathing Filters
- 121 Valved Holding Chamber
- 112-113 Medical Gas Fittings
- 110 O2 Flow Meters
- 114-117 Accessories

SunMed

Ventlab

Ethox

Oxygen Cannula

O₂ CANNULA

LATEX FREE | SINGLE PATIENT USE | DISPOSABLE

Ventlab



Standard O₂ connector;
Fits-All Connector available



1107
Adult O₂ Cannula / FRONT DETAIL



1107
Adult O₂ Cannula / BACK DETAIL

- Curved nares made of ultra-soft material for optimum patient comfort
- 3-Channel tubing prevents kinking
- Fits-All Connector available
- Supply tubing available, 4'- 25' lengths

FITS-ALL CONNECTOR

CAT#	DESCRIPTION	LENGTH	PK
1400F	Neonate O ₂ Cannula	none	50
1407F	Neonate O ₂ Cannula	7'	50
1300F	Infant O ₂ Cannula	none	50
1307F	Infant O ₂ Cannula	7'	50
1315F	Infant O ₂ Cannula	15'	50
1200F	Pediatric O ₂ Cannula	none	50
1207F	Pediatric O ₂ Cannula	7'	50
1215F	Pediatric O ₂ Cannula	15'	50
1007F	Adult O ₂ Cannula (with tab)	7'	50
1100F	Adult O ₂ Cannula	none	50
1104F	Adult O ₂ Cannula	4'	50
1107F	Adult O ₂ Cannula	7'	50
1115F	Adult O ₂ Cannula	15'	50
1125F	Adult O ₂ Cannula	25'	25

STANDARD CONNECTOR

CAT#	DESCRIPTION	LENGTH	PK
1400	Neonate O ₂ Cannula	none	50
1407	Neonate O ₂ Cannula	7'	50
1300	Infant O ₂ Cannula	none	50
1307	Infant O ₂ Cannula	7'	50
1315	Infant O ₂ Cannula	15'	50
1200	Pediatric O ₂ Cannula	none	50
1207	Pediatric O ₂ Cannula	7'	50
1215	Pediatric O ₂ Cannula	15'	50
1007	Adult O ₂ Cannula (with tab)	7'	50
1100	Adult O ₂ Cannula	none	50
1104	Adult O ₂ Cannula	4'	50
1107	Adult O ₂ Cannula	7'	50
1115	Adult O ₂ Cannula	15'	50
1125	Adult O ₂ Cannula	25'	25



Accessory

PEAK FLOW METER

LATEX FREE | SINGLE USE | DISPOSABLE

SunMed



- Economical self-monitoring tool to provide and track information about patient’s response to treatment
- Includes patient use instructions and chart
- Ideal for use with asthma, chronic bronchitis and emphysema cases
- Standard Mini-Wright is tubular, with a spring-loaded piston and a longitudinal slot through which air escapes; scale reads from 60 to 850 liters/minute
- Low Mini-Wright monitors the low range from 30 to 400 liters/minute; correlates closely with the Standard Meter

CAT#	DESCRIPTION	SIZE	PK
8-3548-10	Standard Flow Meter	60-850 LPM	1
8-3548-15	Low Flow Meter	30-400 LPM	1

Accessory

NOSE CLIP

LATEX FREE | SINGLE PATIENT USE | DISPOSABLE

SunMed

- Ideal for use during breathing treatments with peak flow meters and pulmonary function procedures
- Large, soft nose cushions provide patient comfort

CAT#	DESCRIPTION	PK
9-0134-44	Nose Clip	100

Accessory

MOUTHPIECE

LATEX FREE | SINGLE USE | DISPOSABLE

SunMed



- Smooth interior allowing laminar flow
- Constructed of plastic for greater comfort and no cardboard taste
- Large size for standard unit
- Small size for low range unit
- For use with Mini-Write Peak Flow Meter

CAT#	DESCRIPTION	PK
8-3523-20	Large / 2.5" L x 1.1" ID x 1.2" OD	100
8-3523-24	Small / 2.5" L x .775" ID x .875" OD	100
8-3523-21	Large / 2.5" L x 1.1" ID x 1.2" OD	250
8-3523-25	Small / 2.5" L x .775" ID x .875" OD	250
8-3523-22	Large / 2.5" L x 1.1" ID x 1.2" OD	500
8-3523-26	Small / 2.5" L x .775" ID x .875" OD	500



Oxygen Cannula

O₂ DEMAND CANNULA

LATEX FREE | SINGLE PATIENT USE | DISPOSABLE

Ventlab



Demand O₂ Cannula
FRONT DETAIL



Demand O₂ Cannula
BACK DETAIL

- Straight nares made of ultra-soft material for optimum patient comfort
- 3-Channel tubing prevents kinking
- Supply tubing available, 4'- 7' lengths

CAT#	DESCRIPTION	LENGTH	PK
4144	Adult Demand Cannula	4'	25
4145	Adult Demand Cannula	5'	25
4147	Adult Demand Cannula	7'	25

Oxygen Cannula

HIGH FLOW O₂ CANNULA

LATEX FREE | SINGLE PATIENT USE | DISPOSABLE

Ventlab



High Flow O₂ Cannula
FRONT DETAIL



High Flow O₂ Cannula
BACK DETAIL

- Curved nares made of ultra-soft material for optimum patient comfort
- 3-Channel tubing which prevents kinking
- Green supply tubing standard, 4'- 15' lengths
- All versions include Fits-All Connector

Fits-All Connector



CAT#	DESCRIPTION	LENGTH	PK
1104HF	Adult High Flow Cannula	4'	25
1104HFC	Adult High Flow Cannula	4' <i>Clear Tubing</i>	25
1107HF	Adult High Flow Cannula	7'	25
1115HF	Adult High Flow Cannula	15'	25



Oxygen Cannula

HIGH FLOW O₂ CANNULA + HUMIDIFIER TUBE TREE

LATEX | SINGLE PATIENT USE | DISPOSABLE

Ventlab



- High flow bubble humidifier, 6-15LPM
- Humidifier features 6 PSI (414 mbar) pressure relief valve
- Curved nares made of ultra-soft material for optimum patient comfort
- 3-Channel tubing which prevents kinking
- Green supply tubing standard
- Cannula features Fits-All Connector

CAT#	DESCRIPTION	LENGTH	PK
6907	Humidifier + Adult Cannula	7'	10
6915	Humidifier + Adult Cannula	15'	10

Cannula + Circuit Organizer

HIGH FLOW O₂ CANNULA + HUMIDIFIER TUBE TREE

LATEX FREE

SunMed

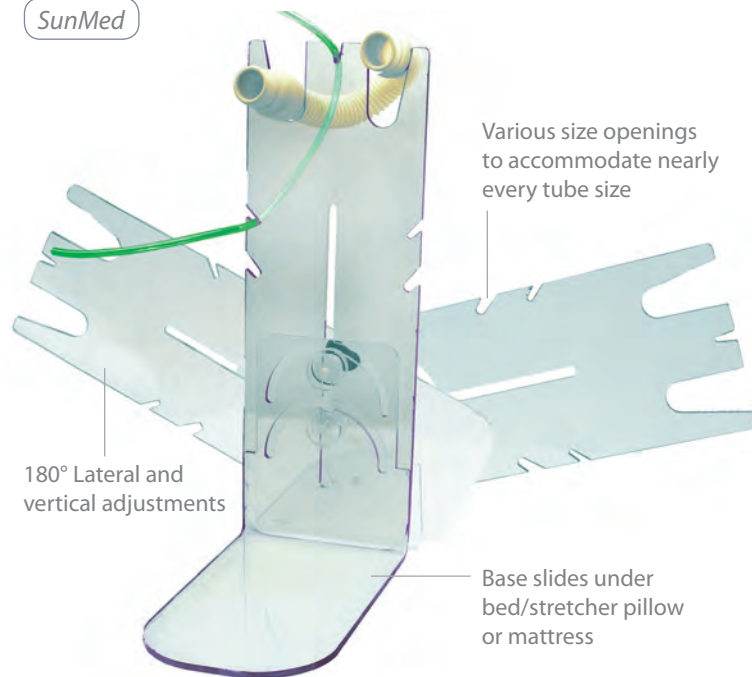

8-0038-04

- Easily restrain oxygen and suction tubing, gas sampling lines
- Effectively manage all three diameter breathing hoses: small disposable plastic, medium reusable rubber and plastic, large king hoses
- Available in stainless steel or clear polycarbonate (PC) for long life
- PC models are more durable than acrylic and can be safely cleaned with alcohol
- PC models accommodate gas sampling tubes
- PC models safe for MRI use
- Each model measures 12.125"H x 5"W x 8.5"D



8-0038-03

8-0038-01

CAT#	DESCRIPTION	PK
8-0038-01	Stainless Steel Tube Tree	1
8-0038-03	Polycarbonate Tube Tree	1
8-0038-04	Adjustable Polycarbonate Tube Tree	1

End Tidal Cannula

ETCO₂ CANNULA

LATEX FREE | SINGLE PATIENT USE | DISPOSABLE

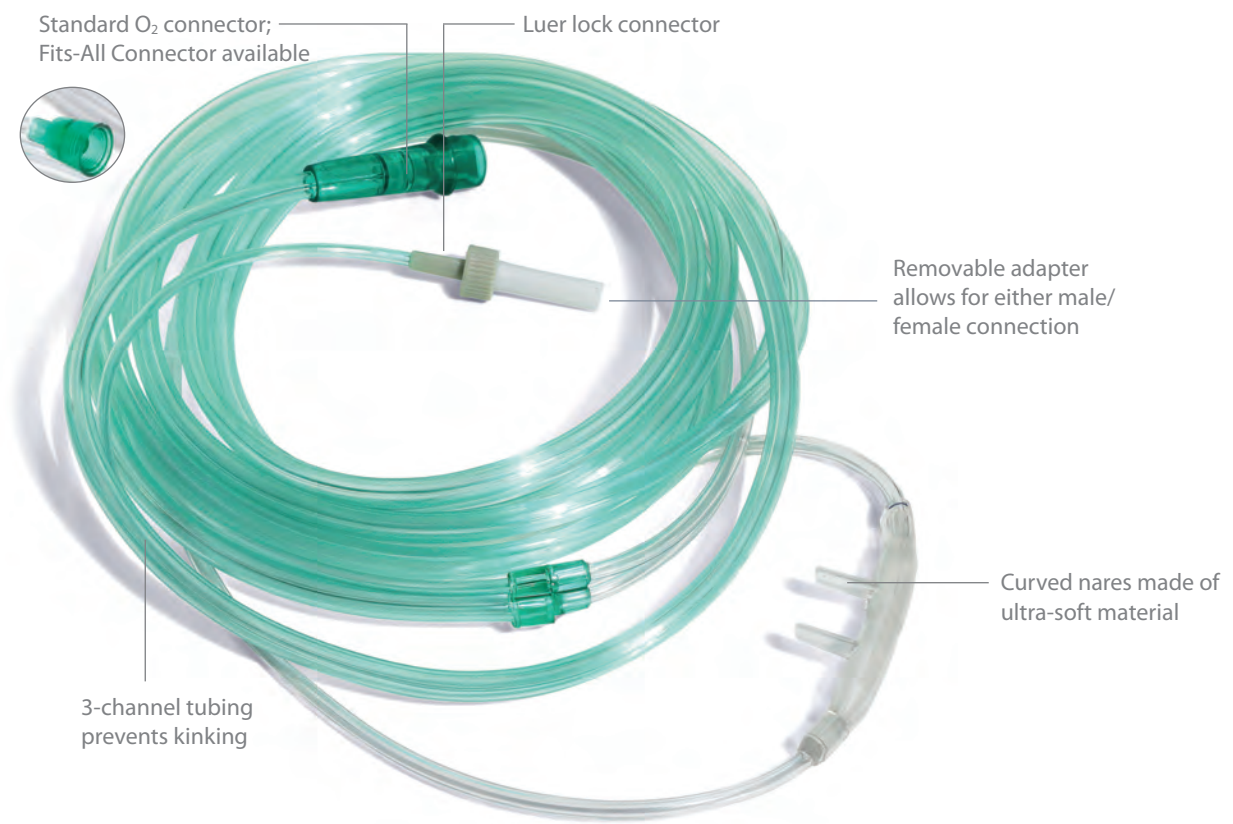

- Delivers oxygen while capturing an end tidal gas sample, even with simultaneous insufflation of oxygen
- Designed help lessen attenuation of the end tidal sample by oxygen dilution
- Dual nasal cannula simultaneously provides oxygen to both nostrils while obtaining CO₂ sampling during spontaneous breathing
- Designed to prevent mixing of fresh oxygen with CO₂
- 3-Channel tubing prevents kinking
- Includes male/female adapter with luer lock connector
- Available in three tubing lengths

SIMULTANEOUSLY DELIVERS OXYGEN + CAPTURES ETCO₂ SAMPLE



Adult ETCO₂ Cannula
DETAIL

FITS-ALL CONNECTOR

CAT#	DESCRIPTION	LENGTH	PK
4107F	Adult ETCO ₂ Cannula	7'	25
4110F	Adult ETCO ₂ Cannula	10'	25
4114F	Adult ETCO ₂ Cannula	14'	25

STANDARD CONNECTOR

CAT#	DESCRIPTION	LENGTH	PK
4107	Adult ETCO ₂ Cannula	7'	25
4110	Adult ETCO ₂ Cannula	10'	25
4114	Adult ETCO ₂ Cannula	14'	25



End Tidal Cannula

ETCO₂ CANNULA + SCOOP

LATEX FREE | SINGLE PATIENT USE | DISPOSABLE

Ventlab

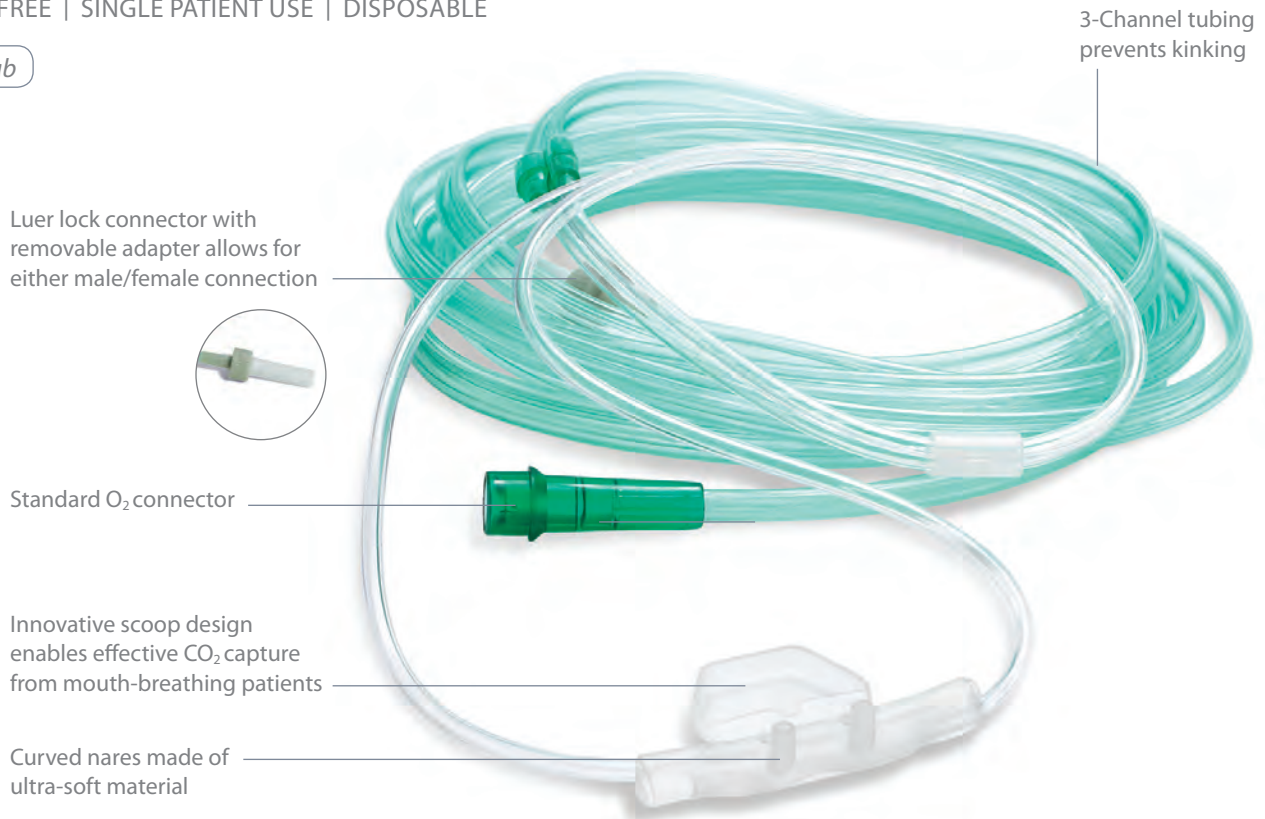

- Innovative design suitable for mouth-breathing patients
- Dual nasal cannula simultaneously provides oxygen to both nostrils while obtaining CO₂ sampling during spontaneous breathing
- Strategically positioned holes deliver O₂, and CO₂ is effectively captured through the nares and scoop
- Designed to prevent mixing of fresh oxygen with CO₂
- Designed to help lessen attenuation of the end tidal sample by oxygen dilution, particularly for mouth-breathing patients
- 3-Channel tubing prevents kinking
- Includes male/female adapter with luer lock connector
- Available in three tubing lengths

UNIQUE SCOOP DESIGN FACILITATES CO₂ CAPTURE IN MOUTH-BREATHING PATIENTS

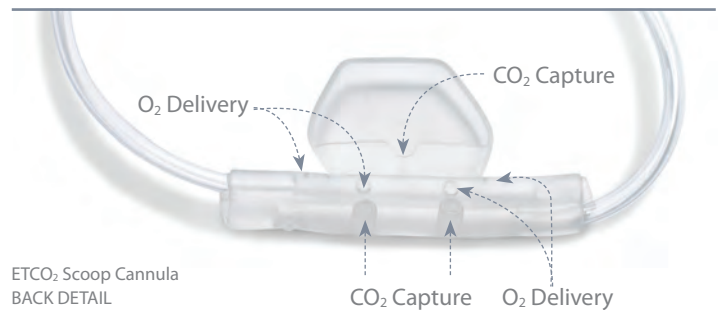

CAT#	DESCRIPTION	LENGTH	PK
4707	Adult ETCO ₂ Cannula	7'	25
4710	Adult ETCO ₂ Cannula	10'	25
4714	Adult ETCO ₂ Cannula	14'	25

Oxygen Mask

HIGH CONCENTRATION

LATEX FREE | SINGLE PATIENT USE | DISPOSABLE

Ventlab



2201
Partial Non-Rebreather



2102
Partial Non-Rebreather

Fits-All Connector
available



- Delivers high concentration of oxygen
- Reservoir bag assures oxygen supply to meet variable breathing patterns and tidal volumes
- Soft, pliable mask fits comfortably on patient
- Includes elastic head strap for best fit
- Transparent PVC mask enables clear visualization of patient
- Swivel connector design ensures uninterrupted flow of oxygen from the bag to the patient
- All sizes include 7' 3-channel oxygen tubing
- Pliable nose clip helps keep mask in place
- Available as non-rebreather or partial non-rebreather
- Designed with two valves on the non-rebreather; one on the partial non-rebreather

PARTIAL NON-REBREATHING ONE VALVE

CAT#	SIZE	DESCRIPTION	PK
2101	Adult	Partial Non-Rebreathing	50
2101F	Adult	Partial Non-Rebreathing + Fits-All Connector	50
2201	Pediatric	Partial Non-Rebreathing	50
2201F	Pediatric	Partial Non-Rebreathing + Fits-All Connector	50
2301	Infant	Partial Non-Rebreathing	50
2301F	Infant	Partial Non-Rebreathing + Fits-All Connector	50

NON-REBREATHING TWO VALVES

CAT#	SIZE	DESCRIPTION	PK
2102	Adult	Non-Rebreathing	50
2102F	Adult	Non-Rebreathing + Fits-All Connector	50
2202	Pediatric	Non-Rebreathing	50
2202F	Pediatric	Non-Rebreathing + Fits-All Connector	50
2302	Infant	Non-Rebreathing	50
2302F	Infant	Non-Rebreathing + Fits-All Connector	50



Oxygen Mask

MEDIUM CONCENTRATION

LATEX FREE | SINGLE PATIENT USE | DISPOSABLE

Ventlab

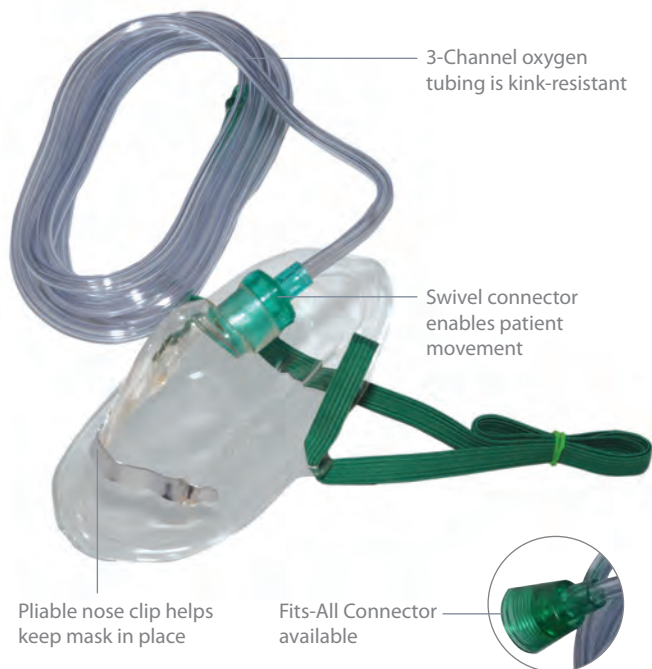

- Flow rate of 6-10 liters per minute
- Delivers an oxygen concentration of 40% to 50% based on breathing rate and tidal volume
- Soft, pliable mask fits comfortably on patient
- Includes elastic head strap for best fit
- Transparent PVC mask enables clear visualization of patient
- O₂ Inlet designed to direct oxygen into the nostrils rather than up toward eyes
- All sizes include 7' 3-Channel oxygen tubing
- Pliable nose clip helps keep mask in place
- Swivel connector enables patient rotation and movement without discomfort

FITS-ALL CONNECTOR

CAT#	SIZE	DESCRIPTION	PK
2100F	Adult	Medium Concentration	50
2200F	Pediatric	Medium Concentration	50
2300F	Infant	Medium Concentration	50

STANDARD CONNECTOR

CAT#	SIZE	DESCRIPTION	PK
2100	Adult	Medium Concentration	50
2200	Pediatric	Medium Concentration	50
2300	Infant	Medium Concentration	50

Oxygen Tubing

OXYGEN TUBING

LATEX FREE | SINGLE PATIENT USE | DISPOSABLE

Ventlab



- Available in clear or semi-transparent green
- Six lengths available
- Three-channel tubing design prevents kinking

CLEAR TUBING

CAT#	DESCRIPTION	LENGTH	PK
3004	Oxygen Supply Tubing	4'	50
3007	Oxygen Supply Tubing	7'	50
3007F	Oxygen Supply Tubing + Fits-All Connector	7'	50
3015	Oxygen Supply Tubing	15'	50
3025	Oxygen Supply Tubing	25'	25
3040	Oxygen Supply Tubing	40'	20
3050	Oxygen Supply Tubing	50'	20

GREEN TUBING

CAT#	DESCRIPTION	LENGTH	PK
3007G	Oxygen Supply Tubing	7'	50
3015G	Oxygen Supply Tubing	15'	50
3025G	Oxygen Supply Tubing	25'	25
3040G	Oxygen Supply Tubing	40'	20
3050G	Oxygen Supply Tubing	50'	20



Oxygen Flow Meter
TRU-FLOW™

LATEX FREE | REUSABLE



- Lexan® inner calibrated flow tube has a lifetime warranty on calibration and manufacturing defects
- 50 psi auxiliary power take-off and double unit configurations available
- Fine-threaded needle valve provides precise gas flow control



ADAPTER FREE INLET

CAT#	DESCRIPTION	PK
8-8151-01	Oxygen 0-15 LPM 1/8" NPT Female Inlet	1



HAND NUT INLET, STANDARD

CAT#	DESCRIPTION	PK
8-8151-04	Oxygen 0-15 LPM with Adapter	1



HAND NUT INLET, TAKE OFF

CAT#	DESCRIPTION	PK
8-8153-04	Oxygen 0-15 LPM Take Off	1



HAND NUT INLET, DOUBLE

CAT#	DESCRIPTION	PK
8-8154-04	Oxygen 0-15 LPM Double	1



OHMEDA INLET, STANDARD

CAT#	DESCRIPTION	PK
8-8151-07	Oxygen 0-15 LPM with Adapter	1



OHMEDA INLET, TAKE OFF

CAT#	DESCRIPTION	PK
8-8153-07	Oxygen 0-15 LPM Take Off	1



OHMEDA INLET, DOUBLE

CAT#	DESCRIPTION	PK
8-8154-07	Oxygen 0-15 LPM Double	1



CHEMETRON INLET, STANDARD

CAT#	DESCRIPTION	PK
8-8151-09	Oxygen 0-15 LPM with Adapter	1



CHEMETRON INLET, TAKE OFF

CAT#	DESCRIPTION	PK
8-8153-09	Oxygen 0-15 LPM Take Off	1



CHEMETRON INLET, DOUBLE

CAT#	DESCRIPTION	PK
8-8154-09	Oxygen 0-15 LPM Double	1



Breathing Circuit
MRI CIRCUIT

LATEX FREE | SINGLE PATIENT USE | DISPOSABLE

Ventlab

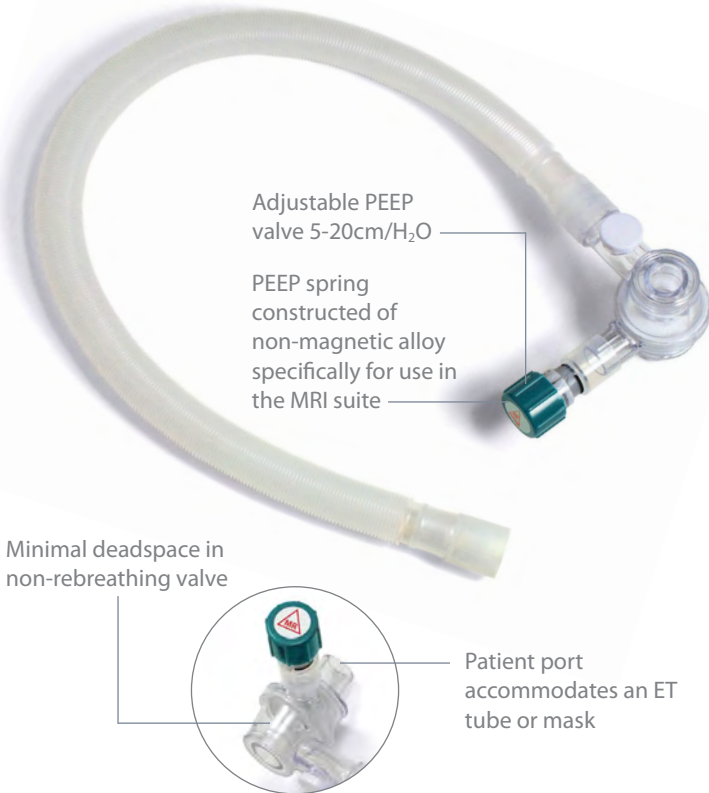

- Patient valve, PEEP valve and oxygen tubing constructed of MRI-safe materials
- 3 o'clock position of PEEP keeps valve out of patient's face
- For use with Smiths Medical Pneupac and other ventilators
(Consult ventilator manufacturer specifications prior to use)
- Corrugating tubing expands generously to 9' for easier ventilation management during procedures
- Circuit available with or without PEEP valve



CAT#	DESCRIPTION	PK
VC1000	MRI Transport Circuit + PEEP Valve	10
VC1000F	MRI Transport Circuit + PEEP Valve + Filter	10
VC1010	MRI Transport Circuit	10
VC1010F	MRI Transport Circuit + Filter	10
VP705	19mm MRI Safe Adjustable PEEP Valve	20

Breathing Circuit
STANDARD CIRCUIT

LATEX FREE | SINGLE PATIENT USE | DISPOSABLE

Ventlab



- Use as a conduit for gases between a Resprionics® positive pressure generator and a patient during non-invasive ventilation
- 72" smooth bore tubing with pressure monitoring line and dual ported adapter
- 24" extension tubing with T-assembly for dual pressure monitoring

CAT#	DESCRIPTION	PK
RC1000	Standard Circuit + 22mm OD Adapter	10



FOR COMPLETE
Customer Service
Technical Information
Care/Cleaning Instructions
Product Literature

CALL
800-433-2797

VISIT
www.Sun-Med.com

EMAIL
info@Sun-Med.com

Medical Gas Fitting

CHEMETRON STEM

LATEX FREE | REUSABLE



- Green, yellow, and white color coding for oxygen, air, and vacuum
- Available in 7 connections to fit a variety of devices



NPT MALE

CAT#	DESCRIPTION	PK
8-1331-01*	Oxy x 1/8"	1
8-1332-01	Air x 1/8"	1
8-1333-01	Vac x 1/8"	1



NPT MALE

CAT#	DESCRIPTION	PK
8-1331-03	Oxy x 1/4"	1
8-1332-03	Air x 1/4"	1
8-1333-03*	Vac x 1/4"	1



NPT FEMALE

CAT#	DESCRIPTION	PK
8-1331-02	Oxy x 1/8"	1
8-1332-02*	Air x 1/8"	1
8-1333-02	Vac x 1/8"	1



DISS MALE

CAT#	DESCRIPTION	PK
8-1331-05*	Oxy x DISS	1
8-1332-05	Air x DISS	1
8-1333-05	Vac x DISS	1



HAND NUT FEMALE

CAT#	DESCRIPTION	PK
8-1331-08	Oxy x Hand Nut	1
8-1332-08	Air x Hand Nut	1
8-1333-08*	Vac x Hand Nut	1



HEX NUT FEMALE

CAT#	DESCRIPTION	PK
8-1331-06	Oxy x Hex Nut	1
8-1332-06*	Air x Hex Nut	1
8-1333-06	Vac x Hex Nut	1



HOSE BARB

CAT#	DESCRIPTION	PK
8-1331-11*	Oxy x 1/4"	1
8-1332-11	Air x 1/4"	1
8-1333-11	Vac x 1/4"	1

*Indicates item pictured



Medical Gas Fitting

OHMEDA STEM

LATEX FREE | REUSABLE



- Green, yellow, and white color coding for oxygen, air, and vacuum
- Available in 7 connections to fit a variety of devices



NPT MALE

CAT#	DESCRIPTION	PK
8-1321-03*	Oxy x 1/4"	1
8-1322-03	Air x 1/4"	1
8-1323-03	Vac x 1/4"	1



NPT FEMALE

CAT#	DESCRIPTION	PK
8-1321-02	Oxy x 1/8"	1
8-1322-02	Air x 1/8"	1
8-1323-02*	Vac x 1/8"	1



NPT MALE

CAT#	DESCRIPTION	PK
8-1321-01	Oxy x 1/8"	1
8-1322-01*	Air x 1/8"	1
8-1323-01	Vac x 1/8"	1



HAND NUT

CAT#	DESCRIPTION	PK
8-1321-08*	Oxy x Hand Nut	1
8-1322-08	Air x Hand Nut	1
8-1323-08	Vac x Hand Nut	1



HEX NUT

CAT#	DESCRIPTION	PK
8-1321-06	Oxy x Hex Nut	1
8-1322-06	Air x Hex Nut	1
8-1323-06*	Vac x Hex Nut	1



DISS MALE

CAT#	DESCRIPTION	PK
8-1321-05	Oxy x DISS	1
8-1322-05*	Air x DISS	1
8-1323-05	Vac x DISS	1



FOR COMPLETE
Customer Service
Technical Information
Care/Cleaning Instructions
Product Literature

CALL
800-433-2797

VISIT
www.Sun-Med.com

EMAIL
info@Sun-Med.com



HOSE BARB

CAT#	DESCRIPTION	PK
8-1321-11	Oxy x 1/4"	1
8-1322-11*	Air x 1/4"	1
8-1323-11	Vac x 1/4"	1

*Indicates item pictured

Inflatable Mask

FLEXIBLE

LATEX FREE | SINGLE PATIENT USE | DISPOSABLE

SunMed



- Reduces wasted anesthetic gas pollution
- Transparent housing for immediate detection of regurgitation or silent aspiration
- Removable color coded hook ring

CAT#	SIZE	DESCRIPTION	COLOR	PK
4-0110-00	Neonate	Inflatable	Gray	30
4-0110-01	Infant	Inflatable	Light Blue	30
4-0110-02	Child	Inflatable	Yellow	30
4-0110-03	Small Adult	Inflatable	Green	30
4-0110-04	Med. Adult	Inflatable	Red	30
4-0110-05	Large Adult	Inflatable	Dark Blue	30

Non-Inflatable Mask

PREMIUM ERGO MASK

LATEX FREE | SINGLE PATIENT USE | DISPOSABLE

Ventlab



- Ergonomic shape combined with finger grips on both front and back of mask provide a secure hold when positioning
- Anti-slip finger grips feature help maintain secure hold even when hands are wet
- Unique anatomical shape and seal enables a firm, yet comfortable patient fit
- Bright color-coding for accurate size selection
- Specifically designed without a cushion to minimize deadspace
- Can be used at higher elevations with non-air cushion design
- Airtight fit available in 6 sizes

CAT#	SIZE	DESCRIPTION	COLOR	PK
VR0900	Small Neonate	ERGO Mask	White	20, 40
VR1900	Small Infant	ERGO Mask	Gray	20, 40
VR2900	Infant	ERGO Mask	Orange	20, 40
VR3900	Small Child	ERGO Mask	Yellow	20, 40
VR4900	Child	ERGO Mask	Blue	20, 40
VR5900	Adult	ERGO Mask	Red	20, 50



Mask

OXYGEN FACE MASK

LATEX FREE | SINGLE PATIENT USE | DISPOSABLE

Ventlab



- Commonly used with valved holding chambers (spacers)
- Soft, pliable latex free material
- Economical choice

CAT#	SIZE	DESCRIPTION	PK
M10	Large	Spacer Mask	10
M20	Medium	Spacer Mask	10
M30	Small	Spacer Mask	10

Accessory

MASK HARNESS

LATEX FREE | REUSABLE

SunMed



- Molded, not stamped
- Reinforced holes on adult size for extra durability
- Neoprene
- Center vents for comfort and fit at back of head

CAT#	SIZE	DESCRIPTION	PK
4-1054-21	Infant, 13" x 2.5"	Mask Harness	1
4-1054-22	Child, 22" x 4"	Mask Harness	1
4-1054-23	Adult, 27" x 5.5"	Mask Harness	1



FOR COMPLETE
Customer Service
Technical Information
Care/Cleaning Instructions
Product Literature

CALL
800-433-2797

VISIT
www.Sun-Med.com

EMAIL
info@Sun-Med.com

Accessory

PEEP VALVE

LATEX FREE | REUSABLE

SunMed



- 5-20cm H₂O
- Designed for use with manual resuscitator/ventilator
- Connects to exhalation port of manual resuscitator

CAT#	SIZE	DESCRIPTION	PK
8-6002-30	30mm ID x 33mm OD	PEEP Valve	1
8-6003-30	30mm ID	PEEP Valve Diverter	1

Accessory

ADJUSTABLE PEEP VALVE

LATEX FREE | SINGLE USE

Ventlab



- 5-20cm H₂O
- Designed for use with manual resuscitator/ventilator
- Connects to exhalation port of manual resuscitator

CAT#	SIZE	DESCRIPTION	PK
VP700	19mm	Adjustable PEEP Valve	20
VP701	30mm	Adjustable PEEP Valve	20
VP702	19mm	Adjustable PEEP Valve + Adapter Converts to 30mm	20
VP703	30mm	Adjustable PEEP Valve + Adapter Converts to 19mm	20
VP705	19mm	MRI Safe Adjustable PEEP Valve	20



Accessory

FLAT BREATHING BAG

LATEX FREE

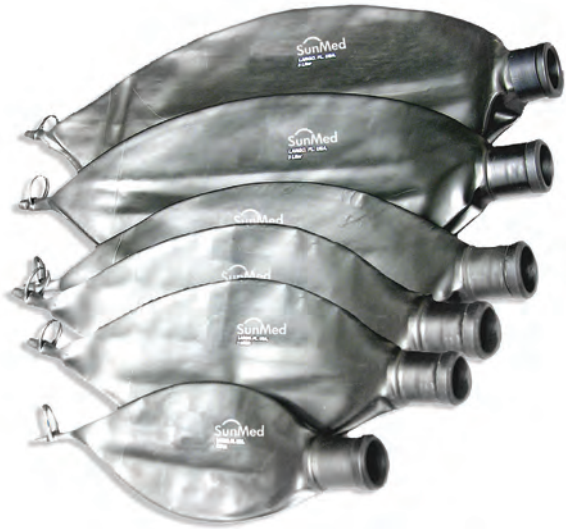

- Constructed of lightweight neoprene material, assuring optimum sensitivity to patients' breathing
- Individually packaged
- 22mm Bushing

CAT#	SIZE	DESCRIPTION	PK
4-1041-05	0.5 Liter	Flat Breathing Bag	1
4-1041-10	1 Liter	Flat Breathing Bag	1
4-1041-15	1.5 Liter	Flat Breathing Bag	1
4-1041-20	2 Liter	Flat Breathing Bag	1
4-1041-30	3 Liter	Flat Breathing Bag	1
4-1041-40	4 Liter	Flat Breathing Bag	1
4-1041-50	5 Liter	Flat Breathing Bag	1

Accessory

TEST LUNG

LATEX FREE



- Use to demonstrate and test ventilator equipment
- Soft, sensitive neoprene
- Foam filled
- Superior quality
- 22mm Bushing

CAT#	SIZE	DESCRIPTION	PK
4-0050-10	1000cc - Large	Test Lung	1
4-0050-50	500-750cc - Medium	Test Lung	1



Humidification





HYDROSCOPIC CONDENSER HUMIFIDER (HCH, HME)

LATEX FREE | SINGLE PATIENT USE | DISPOSABLE



- Effectively provides heat and moisture delivery/recovery for ventilated and spontaneously breathing patients
- Designed with sampling port (unless indicated)
- Available in a variety of sizes and shapes
- Compatible with leading breathing systems
- Bulk packaged (50 EA)

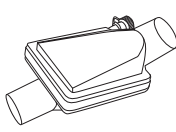

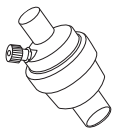
HYDROSCOPIC CONDENSER HUMIDIFIER					
CAT#	FH603007 (no port FH603006)	FH603010	FH603012	FH603014 (no port FH603024)	FH603021 (no port FH603023)
DESCRIPTION	Round	Swivel	Rectangular	Small Angle	Small Straight
VT RANGE (ML)	250 - 1500	250 - 1500	200 - 1500	150 - 100	150 - 1000
MOISTURE OUTPUT (MGH ₂ O/L) ±0.1G	33	34	32	31	31.5
WEIGHT (G)	36.4/27.8	31.8	28.1	24.7	22.3
ID / OD (MM)	22ID x 22OD/15ID	22ID x 22OD/15ID	15ID x 22OD/15ID	15ID x 22OD/15ID	22ID x 22OD/15ID
DEAD SPACE (ML)	90	74	62	36	32
RESISTANCE (CMH ₂ O) 8LPM	<1	<1	<1	<1	<1
RESISTANCE (CMH ₂ O) 30LPM	<1	<1	<1	<1	<1

Breathing Filter

HEPA FILTER

LATEX FREE | SINGLE PATIENT USE | DISPOSABLE



- >150ml Tidal volume
- 99.99% Filtering efficiency
- 54ml Dead space



Humidification

BUBBLE HUMIDIFIER

LATEX FREE | SINGLE USE | DISPOSABLE



- 6-15LPM
- Features 6 PSI (414 mbar) pressure relief valve



CAT#	DESCRIPTION	SIZE	PK
FH603026	HEPA Filter	22ID x 15ID x 22OD	50

CAT#	DESCRIPTION	PK
6900	Bubble Humidifier	10



Humidification & Filtration



HYDROSCOPIC CONDENSER HUMIDIFIER + FILTER (HCHF, HMEF)

LATEX FREE | SINGLE PATIENT USE | DISPOSABLE

Ventlab

- Filters up to 99.99% of expiratory bacterial/viral content
- Effectively provides heat and moisture delivery/recovery for ventilated and spontaneously breathing patients
- Designed with sampling port (unless indicated)
- Available in a variety of sizes and shapes
- Compatible with leading breathing systems
- Bulk packaged (50 EA)

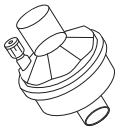

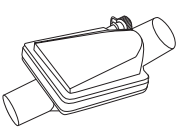
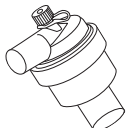
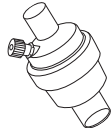
HYDROSCOPIC CONDENSER HUMIDIFIER WITH FILTER					
CAT#	FH603008 (no port FH603005)	FH603009	FH603011	FH603013 (no port FH603025)	FH603020 (no port FH603022)
DESCRIPTION	Round	Swivel	Rectangular	Small Angle	Small Straight
VT RANGE (ml)	250 - 1500	250 - 1500	200 - 1500	150 - 100	150 - 1000
MOISTURE OUTPUT (MGH ₂ O/L) ±0.1G	33	36	32.5	31.5	31
WEIGHT (G)	37.2/31.3	34.6	26.6	23.6	22.8
ID / OD (MM)	22ID x 22OD/15ID	22ID x 22OD/15ID	22ID x 22OD/15ID	15ID x 22OD/15ID	15ID x 22OD/15ID
DEAD SPACE (ML)	90	74	62	36	32
RESISTANCE (CMH ₂ O) 8LPM	<1	<1	<1	<1	<1
RESISTANCE (CMH ₂ O) 30LPM	<1	<2	<1	<3	<2
B/V EFFICIENCY	>99.99%	>99.99%	>99.99%	>99.99%	>99.99%

Filter Accessory

FLEX TUBING FOR HME/HMEF

LATEX FREE | SINGLE PATIENT USE | DISPOSABLE

Ventlab

- For use with hygroscopic condenser humidifiers
- Standard 6", 15mm flex tubing

CAT#	DESCRIPTION	FLEX TUBE	PK
FH106347	15mm OD x 15mm OD	6" x 15mm ID	50
FH106348	15mm OD x 22mm OD/15mm ID	6" x 15mm ID	50
FH106380	15mm OD x 22mmOD/15mm ID 15mm OD connector	6" x 15mm ID	50

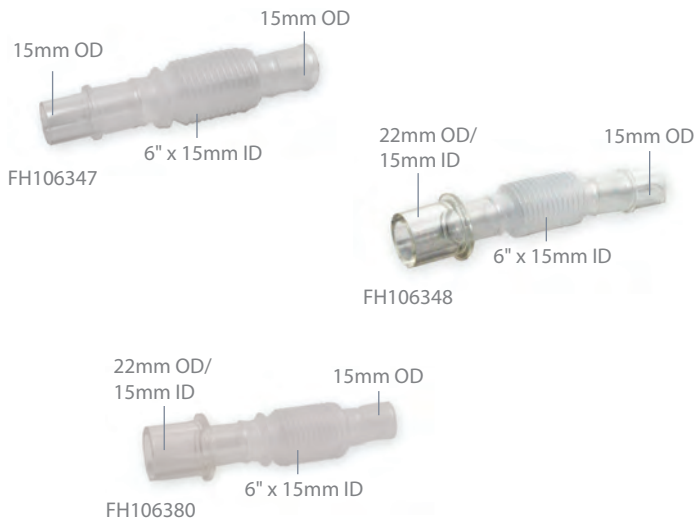

Breathing Filter

BACTERIAL / VIRAL FILTER

LATEX FREE | SINGLE PATIENT USE | DISPOSABLE

Ventlab

- Help reduce the transmission of microbes and other particulate matter in the breathing system
- Filters up to 99.99% of expiratory bacterial/viral content
- Designed to reduce drag on the breathing system while ensuring patient comfort
- Available in a variety of sizes and shapes
- Compatible with leading breathing systems
- Bulk packaged (50 EA)

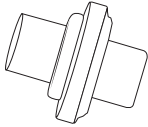
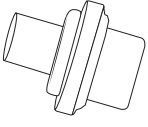
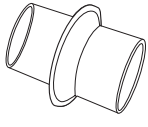
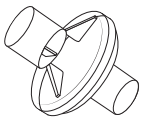
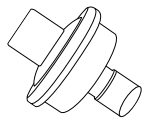

BACTERIAL / VIRAL FILTER					
CAT#	BF101	BF102	BF103	FH603003	FH603026
DESCRIPTION	Accepts 19mm	Accepts 19mm or 30mm	Accepts 19mm or 30mm	Vt Range >250ml	Tidal Volume >150ml
B/V EFFICIENCY	>99.99%	>99.99%	>99.99%	>99.99%	>99.99%
WEIGHT (G)	9.6	11.8	12.4	25.0/25.7	40.6
ID / OD (MM)	19ID x 19ID	19ID x 22ID / 30 OD	30ID x 22ID / 30OD	22ID x 15ID / 22OD	22ID x 15ID / 22OD
DEAD SPACE (ML)	16	20	29	54	54
RESISTANCE (CMH ₂ O) 30LPM	<1.8	<2.2	<2	<1 (<2 @60LPM)	<1.4
SAMPLING PORT	No	No	No	No/Yes	Yes

Breathing Filter Accessory

FLEX TUBING FOR B/V FILTERS

LATEX FREE | SINGLE PATIENT USE | DISPOSABLE

Ventlab

- For use with bacterial/viral filters
- Standard 6", 15mm flex tubing

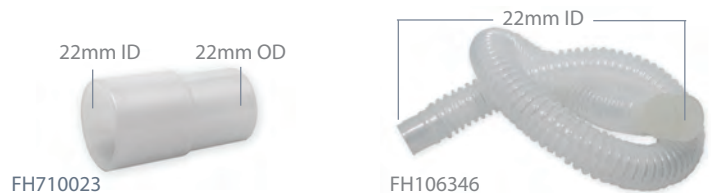

CAT#	DESCRIPTION	PK
FH710023	Cuff / 22mm ID x 22mm OD	50
FH106346	Adapter / 22mm ID x 22mm ID with 22mm 24" Corrugated Tubing	50



Medication Delivery

BREATHERITE VALVED HOLDING CHAMBER / MDI SPACER

LATEX FREE | SINGLE PATIENT USE | REUSABLE

Ventlab

This product has been manufactured with materials that do not contain BPA

22mm OD mouthpiece fits most face masks (can be used with or without mask)



Low resistance exhalation valve angles away from patient's face

Collapsible version makes it portable, promoting patient use



Geometrically correct chamber allows for natural expansion of medication plume

MDI Port
Inspiratory aperture promotes proper inspiratory rate

- Anti-static chamber enables effective medication delivery
- Designed to promote greater drug volume output
- Inspiratory aperture ensures proper inspiratory rate
- Chamber design eliminates the need for a flow signal since whistling signals are shown to confuse users
- Collapsible version makes it very portable
- Face mask (all detachable) options available; can be used with or without mask

COLLAPSIBLE CAT#	RIGID CAT#	VHC + TYPE OF MASK	MASK SIZE	PK
BR200	BR300	No mask - VHC only	-	20
BR210	BR310	Economy Spacer Mask	Adult	20
BR220	BR320	Economy Spacer Mask	Pediatric	20
BR230	BR330	Economy Spacer Mask	Infant	20
BR201	BR301	Inflatable Vent Mask	Small Infant	20
BR202	BR302	Inflatable Vent Mask	Infant	20
BR203	BR303	Inflatable Vent Mask	Small Child	20
BR204	BR304	Inflatable Vent Mask	Child	20
BR205	BR305	Inflatable Vent Mask	Adult	20
BR200-I	BR300-I	Premium ERGO Mask	Small Neonate	20
BR201-I	BR301-I	Premium ERGO Mask	Small Infant	20
BR202-I	BR302-I	Premium ERGO Mask	Infant	20
BR203-I	BR303-I	Premium ERGO Mask	Small Child	20
BR204-I	BR304-I	Premium ERGO Mask	Child	20
BR205-I	BR305-I	Premium ERGO Mask	Adult	20

FACE MASK OPTIONS



EMERGENCY



- 124-127 Airways
- 127-129 Intubation Aids
- 130-133 Resuscitators / Ventilators
- 134 Gastric Lavage
- 136 Wound Irrigation
- 135-139 Emergency Accessories

SunMed

Ventlab

Ethox

Oropharyngeal Airway

BERMAN

LATEX FREE | SINGLE USE | DISPOSABLE



- Firm, polyethylene plastic
- Vented septum
- Built-in bite block
- Sets are ideal for crash carts
- Individually wrapped

INDIVIDUAL

CAT#	SIZE	DESCRIPTION	COLOR	PK
1-1508-40	4cm / 40mm	Newborn	Pink	10
1-1508-50	5cm / 50mm	Infant	Blue	10
1-1508-60	6cm / 60mm	Small Child	Black	10
1-1508-70	7cm / 70mm	Child	White	10
1-1508-80	8cm / 80mm	Small Adult	Green	10
1-1508-90	9cm / 90mm	Medium Adult	Yellow	10
1-1508-99	10cm / 100mm	Large Adult	Red	10
1-1508-11	11cm / 110mm	X-Large Adult	Orange	10
1-1506-40	4cm / 40mm	Newborn	Pink	50
1-1506-50	5cm / 50mm	Infant	Blue	50
1-1506-60	6cm / 60mm	Small Child	Black	50
1-1506-70	7cm / 70mm	Child	White	50
1-1506-80	8cm / 80mm	Small Adult	Green	50
1-1506-90	9cm / 90mm	Medium Adult	Yellow	50
1-1506-99	10cm / 100mm	Large Adult	Red	50
1-1506-11	11cm / 110mm	X-Large Adult	Orange	50

SETS

CAT#	SIZES INCLUDED	PK
1-1508-00	40mm, 50mm, 60mm, 70mm, 80mm, 90mm, 100mm, 110mm (1 of each size per set; 10 sets per pack)	10

Oropharyngeal Airway

TRADITIONAL GUEDEL

LATEX FREE | SINGLE USE | DISPOSABLE



- Firm, polyethylene plastic
- One piece construction
- Built-in bite block
- Sets are ideal for crash carts
- Bulk packaged

INDIVIDUAL

CAT#	SIZE	DESCRIPTION	COLOR	PK
1-1501-50	5cm	Infant, 50mm	Blue	10
1-1501-60	6cm	Small Child, 60mm	Black	10
1-1501-70	7cm	Child, 70mm	White	10
1-1501-80	8cm	Small Adult, 80mm	Green	10
1-1501-90	9cm	Med. Adult, 90mm	Yellow	10
1-1501-99	10cm	Large Adult, 100mm	Red	10
1-1500-50	5cm	Infant, 50mm	Blue	50
1-1500-60	6cm	Small Child, 60mm	Black	50
1-1500-70	7cm	Child, 70mm	White	50
1-1500-80	8cm	Small Adult, 80mm	Green	50
1-1500-90	9cm	Med. Adult, 90mm	Yellow	50
1-1500-99	10cm	Large Adult, 100mm	Red	50

SETS

CAT#	SIZES INCLUDED	PK
1-1501-00	50, 60, 70, 80, 90, 100 mm (1 of each size per set/pack)	1



Nasopharyngeal Airway

LATEX FREE ROBERTAZZI

STERILE | LATEX FREE | SINGLE USE | DISPOSABLE

SunMed



- Flexible neoprene performs like latex airways
- Soft material prevents damage to nasal passage
- Blunt tip
- Resists collapse or kinking
- Sets are ideal for crash carts
- Individually sterile packaged

INDIVIDUAL

CAT#	SIZE	ID	OD	LENGTH	PK
1-5075-20	20Fr	5.0mm	6.7mm	115mm	10
1-5075-22	22Fr	5.5mm	7.3mm	120mm	10
1-5075-24	24Fr	6.0mm	7.6mm	120mm	10
1-5075-26	26Fr	6.5mm	8.6mm	130mm	10
1-5075-28	28Fr	7.0mm	9.3mm	135mm	10
1-5075-30	30Fr	7.5mm	10.0mm	135mm	10
1-5075-32	32Fr	8.0mm	10.7mm	145mm	10
1-5075-34	34Fr	8.5mm	11.2mm	160mm	10
1-5075-36	36Fr	9.0mm	12.0mm	175mm	10

SETS

CAT#	SIZES INCLUDED	PK
1-5075-04	20, 24, 28, 32Fr + sterile lubricating jelly	4/Pk
1-5075-06	22, 24, 26, 28, 30, 32Fr + sterile lubricating jelly	6/Pk
1-5075-09	20, 22, 24, 26, 28, 30, 32, 34, 36Fr + sterile lubricating jelly	9/Pk

Nasopharyngeal Airway

ADJUSTABLE AIRWAY

STERILE | LATEX FREE | SINGLE USE | DISPOSABLE

SunMed



- Flexible neoprene performs like latex airways
- Soft material prevents damage to nasal passage
- Soft, adjustable flange
- Blunt tip
- Resists collapse or kinking
- Individually sterile packaged

INDIVIDUAL

CAT#	SIZE	ID	OD	LENGTH	PK
1-5072-12	12Fr	3.0mm	4.0mm	95mm	10
1-5072-14	14Fr	3.5mm	4.7mm	95mm	10
1-5072-16	16Fr	4.0mm	5.3mm	95mm	10
1-5072-18	18Fr	4.5mm	6.0mm	95mm	10
1-5072-20	20Fr	5.0mm	6.7mm	115mm	10
1-5072-22	22Fr	5.5mm	7.3mm	120mm	10
1-5072-24	24Fr	6.0mm	7.6mm	120mm	10
1-5072-26	26Fr	6.5mm	8.6mm	130mm	10
1-5072-28	28Fr	7.0mm	9.3mm	170mm	10
1-5072-30	30Fr	7.5mm	10.0mm	170mm	10
1-5072-32	32Fr	8.0mm	10.7mm	170mm	10
1-5072-34	34Fr	8.5mm	11.2mm	170mm	10
1-5072-36	36Fr	9.0mm	12.0mm	170mm	10



Endotracheal Tube

MURPHY EYE

STERILE | LATEX FREE | SINGLE USE | DISPOSABLE



- Oral and nasal use
- Clear, flexible PVC
- Smooth Murphy Eye for alternative ventilation port
- Available cuffed, uncuffed, reinforced and with stylette
- Economical
- High volume, low pressure cuff
- Large barrel cuff
- Standard 15mm ISO connector included with each tube
- Latex free, single use, sterile



CUFFED

CAT#	ID	SIZE	LENGTH	PK
1-7333-25	2.5mm	10Fr	150mm	10
1-7333-30	3.0mm	12Fr	165mm	10
1-7333-35	3.5mm	14Fr	185mm	10
1-7333-40	4.0mm	16Fr	210mm	10
1-7333-45	4.5mm	18Fr	225mm	10
1-7333-50	5.0mm	20Fr	245mm	10
1-7333-55	5.5mm	22Fr	275mm	10
1-7333-60	6.0mm	24Fr	285mm	10
1-7333-65	6.5mm	26Fr	295mm	10
1-7333-70	7.0mm	28Fr	310mm	10
1-7333-75	7.5mm	30Fr	315mm	10
1-7333-80	8.0mm	32Fr	330mm	10
1-7333-85	8.5mm	34Fr	330mm	10
1-7333-90	9.0mm	36Fr	330mm	10
1-7333-95	9.5mm	38Fr	330mm	10



CUFFED WITH STYLETTE

CAT#	ID	SIZE	LENGTH	PK
1-7343-30	3.0mm	12Fr	165mm	10
1-7343-35	3.5mm	14Fr	185mm	10
1-7343-40	4.0mm	16Fr	210mm	10
1-7343-45	4.5mm	18Fr	225mm	10
1-7343-50	5.0mm	20Fr	245mm	10
1-7343-55	5.5mm	22Fr	275mm	10
1-7343-60	6.0mm	24Fr	285mm	10
1-7343-65	6.5mm	26Fr	295mm	10
1-7343-70	7.0mm	28Fr	310mm	10
1-7343-75	7.5mm	30Fr	315mm	10
1-7343-80	8.0mm	32Fr	330mm	10
1-7343-85	8.5mm	34Fr	330mm	10
1-7343-90	9.0mm	36Fr	330mm	10
1-7343-95	9.5mm	38Fr	330mm	10
1-7343-10	10.0mm	40Fr	330mm	10



UNCUFFED

CAT#	ID	SIZE	LENGTH	PK
1-7330-20	2.0mm	8Fr	140mm	10
1-7330-25	2.5mm	10Fr	145mm	10
1-7330-30	3.0mm	12Fr	165mm	10
1-7330-35	3.5mm	14Fr	185mm	10
1-7330-40	4.0mm	16Fr	210mm	10
1-7330-45	4.5mm	18Fr	225mm	10
1-7330-50	5.0mm	20Fr	245mm	10
1-7330-55	5.5mm	22Fr	275mm	10



Tracheostomy Tube

TRACHEOSTOMY

STERILE | LATEX FREE | SINGLE USE | DISPOSABLE

SunMed



- Obturator and tube clearly marked
- 15mm Connector swivel adapter
- Soft PVC
- Secure neck band retainer
- Cushion neck band comfortable for patient
- Radiopaque strip embedded for exact location of tube
- Low pressure cuff

UNCUFFED

CAT#	ID	SIZE	LENGTH	PK
1-7390-30	3.0mm	12Fr	160mm	10
1-7390-35	3.5mm	14Fr	180mm	10
1-7390-40	4.0mm	16Fr	200mm	10
1-7390-45	4.5mm	18Fr	220mm	10
1-7390-50	5.0mm	20Fr	240mm	10

CUFFED

CAT#	ID	SIZE	LENGTH	PK
1-7393-50	5.0mm	20Fr	240mm	10
1-7393-55	5.5mm	22Fr	270mm	10
1-7393-60	6.0mm	24Fr	280mm	10
1-7393-65	6.5mm	26Fr	290mm	10
1-7393-70	7.0mm	28Fr	300mm	10
1-7393-75	7.5mm	30Fr	310mm	10
1-7393-80	8.0mm	32Fr	320mm	10
1-7393-85	8.5mm	34Fr	320mm	10
1-7393-90	9.0mm	36Fr	320mm	10
1-7393-95	9.5mm	38Fr	320mm	10
1-7393-10	10.0mm	40Fr	320mm	10

Introducer

BOUGIE-TO-GO

STERILE | LATEX FREE | SINGLE USE | DISPOSABLE

SunMed



- Innovative compact packaging designed specifically for use by EMS professionals
- Low density polyethylene provides proper stiffness for ease of insertion
- Calibrated to ensure accurate distance insertion
- Fits in 6mm to 11mm tubes

CAT#	SIZE	DESCRIPTION	PK
9-0212-82	15FR x 60cm	Adult, Coudé Tip	10



The Bougie-To-Go is specially packaged to fit in smaller compartments, bags, and even pockets, making it ideal for first responders



Intubation

INTUBATION KIT

LATEX FREE



Complete intubation kits available with conventional, fiber optic or fiber optic disposable laryngoscope blades

Each kit includes:

- 8 Oropharyngeal color coded Guedel airways (sizes 40mm-100mm)
- 1 Penlite chrome plated laryngoscope handle
- 1 Medium chrome plated laryngoscope handle
- 5 Miller laryngoscope blades (sizes 0-4)
- 4 Macintosh laryngoscope blades (sizes 1-4)
- 4 Extra laryngoscope lamps (2 small, 2 large)
- 1 Adult Magill forceps
- 1 Pediatric Magill forceps
- 2 "C" batteries
- 2 "AA" batteries
- 4 Packets of sterile lubricating jelly
- 2 Endotracheal uncuffed tubes (sizes 2.5, 4mm)
- 8 Endotracheal cuffed tubes (sizes 5-10mm)
- 4 Nasopharyngeal airways (sizes 20, 24, 28, 32FR)
- 1 10ml syringe
- 1 Endotracheal tube introducer (bougie) with coude tip
- 1 Adult stylette
- 1 Nylon airway management case

CAT#	KIT INCLUDES	PK
8-1050-85	Conventional Intubation Kit Includes items above + Conventional Laryngoscope Blades	1 Kit
8-1050-95	Fiber Optic Intubation Kit Includes items above + Reusable FO Laryngoscope Blades	1 Kit
8-1050-94	Single-Use Fiber Optic Intubation Kit Includes items above + Disposable FO Single Use Laryngoscope Blades	1 Kit
8-1050-80	Nylon Case Only	1

8-1050-95 Fiber Optic Intubation Kit
Batteries, lubricating jelly, and syringe not shown.



GreenLine® Fiber Optic Laryngoscope

DISPOSABLE LARYNGOSCOPE KITS

LATEX FREE | SINGLE USE | DISPOSABLE

SunMed



- Ideal for ambulances, paramedics and first responders
- Variety of blade/handle combinations in most popular sizes
- All blades are single patient use and disposable
- Available with either single use or reusable handles
- Components arrive in original packaging inside sturdy canvas pouch

CAT#	KIT INCLUDES	PK
5-5332-55	2 Disposable Standard Handles (5-5338-12) Macintosh Blades: 2 (5-5332-02), 3 (5-5332-03), 4 (5-5332-04), Miller Blades: 2 (5-5333-02), 3 (5-5333-03), Canvas Pouch	1
5-5332-57	Disposable Standard Handle (5-5338-12) Disposable Stubby Handle (5-5338-11) Macintosh Blades: 2 (5-5332-02), 3 (5-5332-03), 4 (5-5332-04), Miller Blades: 2 (5-5333-02), 3 (5-5333-03), Canvas Pouch	1
5-5336-54	2 Disposable Penlite Handles (5-5338-10) All-Metal Macintosh Blade: 1 (5-5335-01), All-Metal Miller Blades: 00 (5-5336-20), 0 (5-5336-00), 1 (5-5336-01) Canvas Pouch	1
5-5333-58	2 Disposable Standard Handles (5-5338-12) Macintosh Blades: 2 (5-5332-02), 3 (5-5332-03), 4 (5-5332-04), Miller Blades: 0 (5-5333-20), 1 (5-5333-01), 2 (5-5333-02), 3 (5-5333-03), Canvas Pouch	1
5-5333-57	Chrome Plated Med. Handle (5-0236-09) Macintosh Blades: 2 (5-5332-02), 3 (5-5332-03), 4 (5-5332-04), Miller Blades: 0 (5-5333-20), 1 (5-5333-01), 2 (5-5333-02), 3 (5-5333-03), Canvas Pouch	1
5-5335-47	Chrome Plated Med. Handle (5-0236-99) All-Metal Macintosh Blades: 2 (5-5335-02), 3 (5-5335-03), 4 (5-5335-04) All-Metal Miller Blades: 0 (5-5336-00), 1 (5-5336-01), 2 (5-5336-02), 3 (5-5336-03) Canvas Pouch	1

DISPOSABLE KITS + DISPOSABLE HANDLES

5-5332-55
GreenLine/D,
5 Blades,
Standard Kit

5-5332-57
GreenLine/D,
5 Blades,
Stubby Kit

5-5336-54
All-Metal,
4 Blades,
Penlite Kit

5-5333-58
GreenLine/D,
7 Blades,
Standard Kit

DISPOSABLE KITS + REUSABLE CHROME PLATED HANDLES

5-5333-57
GreenLine/D,
7 Blades,
Chrome Kit

5-5335-47
All-Metal,
7 Blades,
Chrome Kit



Manual Resuscitator / Ventilator

AIRFLOW

LATEX FREE | SINGLE PATIENT USE | DISPOSABLE

Ventlab



Bacterial/viral filter protects clinician from contaminated expiration content

Patient port swivel allows clinician to easily move around patient while maintaining proper resuscitation

Integrated pressure manometer to promote proper pressure delivery

Pliable bag body allows very good tactile feel of patient's lung compliance

Red fits-all O₂ tubing connector enables quick visualization of proper O₂ connection

- Single patient use manual resuscitation/ventilation bag available in five sizes/volumes
- All series include bacterial/viral filter, oxygen reservoir and mask
- Available with or without integrated pressure manometer
- Integrated color-coded pressure manometer effectively promotes proper pressure delivery (<20cmH₂O); the tri-color fields alert to the risk level of delivered pressure
- Accurate pressure delivery helps reduce gastric insufflation, thus preventing vomiting, aspiration and resulting pneumonia
- Face mask proportionately sized to resuscitation bag size
- Select from a variety of components to assemble a custom resuscitation bag to meet your unique patient needs

Adult AirFlow AF1140-Series Shown with B/V filter, integrated pressure manometer and inflatable adult mask

AIRFLOW + INTEGRATED PRESSURE MANOMETER

CAT#	SIZE	VOLUME	STROKE VOLUME	PK
AF2140MB	Pediatric	1000ml	650-670ml	10
AF3140MB	Infant	300ml	150-170ml	10
AF4140MB	Child	550ml	320-340ml	10
AF5140MB	Adult	1500ml	640-660ml	10
AF1140MB	Adult	1900ml	950-960ml	10

AIRFLOW STANDARD (WITHOUT PRESSURE MANOMETER)

CAT#	SIZE	VOLUME	STROKE VOLUME	PK
AF2040MB	Pediatric	1000ml	650-670ml	10
AF3040MB	Infant	300ml	150-170ml	10
AF4040MB	Child	550ml	320-340ml	10
AF5040MB	Adult	1500ml	640-660ml	10
AF1040MB	Adult	1900ml	950-960ml	10

CUSTOMIZE YOUR RESUSCITATION / VENTILATION BAG

Choose from the following components to create a custom resuscitation/ventilation bag to best meet your needs:

OXYGEN RESERVOIRS



INFLATABLE O₂ BAG

Closed system oxygen reservoir delivers higher FDO₂ and provides visual indication of proper airflow



CORRUGATED TUBING

For use with secondary oxygen supply; available in 24" and 48" lengths



COLLAPSIBLE/EXTENDABLE O₂ ACCUMULATOR

Available only for AF1000 series

CONVENIENCE COMPONENTS



FACE MASKS

Inflatable and non-inflatable face masks available



FLEX NECK

Removable, flexible joint allows corrugated tubing to be joined with the patient valve; also reduces the torque on ET tube



HAND STRAP

Maintain a positive grip with a hand strap



AirFlow bags come standard with an inflatable mask on Adult bag sizes. All other size bags come with non-inflatable masks.

Infant AirFlow
AF3140-Series

SAFETY COMPONENTS



INTEGRATED PRESSURE MANOMETER

Ventlab's innovative color-coded dial clearly denotes pressure delivery:

Green - Target pressure level <20cmH₂O
Yellow - Potentially dangerous pressure level
Red - Dangerous pressure level



POP-OFF VALVES

40cm/H₂O & 25cm/H₂O
Allows clinician to use an appropriate pop-off level



FILTERS

A bacterial/viral filter provides effective protection for the healthcare provider during expiration



CO₂ INDICATOR

The STAT-Check II is an effective assessment tool for verifying CO₂ exchange



PEEP VALVES

Adjustable PEEP valves; 5-20cm/H₂O

Manual Resuscitator / Ventilator

SAFE SPOT

LATEX FREE | SINGLE PATIENT USE | DISPOSABLE

Ventlab

Patient port swivel allows clinician to easily move around patient while maintaining proper resuscitation

Pliable silicone bag body with indented, thin-walled 'safe spots' effectively enhance tactile feel of lung compliance

Integrated pressure manometer to promote proper pressure delivery

Pop-off valve allows clinician to use an appropriate pop-off level

Red Fits-All O₂ tubing connector enables quick visualization of proper O₂ connection

- Single patient use manual resuscitation/ventilation system designed specifically for infant patients
- Bag features ultra-thin 'spots' to provide an enhanced tactile feel for lung compliance and increased patient safety
- Integrated pressure manometer promotes proper delivery (<20cmH₂O) to guard against over-pressurization of babies' fragile lungs; the tri-color fields alert to the risk level of delivered pressure
- Accurate pressure delivery helps reduce barotrauma or pneumothoraces
- Pop-off valve (40cm/H₂O and 25cm/H₂O available) enables clinicians to use the pop off level appropriate for a given patient population creating a greater margin of safety for the baby
- Optional Vent Mask in various sizes available
- Select from a variety of components to assemble a custom resuscitation bag to meet your unique patient needs

Safe Spot
SS3200-Series

Shown with integrated pressure manometer, pop-off valve, and inflatable O₂ reservoir

CAT#	SIZE	VOLUME	STROKE VOLUME	PK
SS3200MB	Infant	250ml	140-170ml	10



CUSTOMIZE YOUR RESUSCITATION / VENTILATION BAG

Choose from the following components to create a custom resuscitation/ventilation bag to best meet your needs:



Safe Spot bags come standard with an inflatable Vent Mask

Safe Spot SS3200-Series

Shown with integrated pressure manometer, pop-off valve, and corrugated tubing

OXYGEN RESERVOIRS



INFLATABLE O₂ BAG

Closed system oxygen reservoir delivers higher FDO₂ and provides visual indication of proper airflow



CORRUGATED TUBING

For use with secondary oxygen supply; available in 24" and 48" lengths

CONVENIENCE COMPONENTS



FACE MASKS

Inflatable and non-inflatable face masks available

SAFETY COMPONENTS



INTEGRATED PRESSURE MANOMETER

Ventlab's innovative color-coded dial clearly denotes pressure delivery:

- Green** - Target pressure level <20cmH₂O
- Yellow** - Potentially dangerous pressure level
- Red** - Dangerous pressure level



POP-OFF VALVES

40cm/H₂O & 25cm/H₂O
Allows clinician to use an appropriate pop-off level



FILTERS

A bacterial/viral filter provides effective protection for the healthcare provider during expiration



CO₂ INDICATOR

The STAT-Check II is an effective assessment tool for verifying CO₂ exchange



PEEP VALVES

Adjustable PEEP valves; 5-20cm/H₂O



Gastric Lavage

TUM-E-VAC® GASTRIC LAVAGE KIT

LATEX FREE | SINGLE USE | DISPOSABLE

Ethox



- Pre-assembled kits are quick and easy to use, reducing the time for lavage procedures
- Promotes quick, efficient lavage of stomach contents
- Closed system helps prevent exposure to stomach contents and charcoal solutions
- Available with activated charcoal suspension (with or without Sorbitol)
- Twist-Lok™ expressing key aids in charcoal administration
- Easy-to-fill top port
- Available with Universal Solution Spike (for use with pre-filled solution containers)
- No clean up or disinfecting procedures necessary
- All kits come standard with Bite Block

WITHOUT CHARCOAL

CAT#	DESCRIPTION	PK
2054	Tum-E-Vac + 3L Solution Bag + 32Fr Lavage Tubing	10
2055	Tum-E-Vac + 3L Solution Bag	10
2075	Tum-E-Vac + Universal Solution Spike	10
2060	Tum-E-Vac Bite Block Only	50

WITH ACTIVATED CHARCOAL

CAT#	DESCRIPTION	PK
2057	Tum-E-Vac + 32Fr Lavage Tubing + (2) 25g Activated Charcoal	10
2058	Tum-E-Vac + 32Fr Lavage Tubing + (2) 25g Activated Charcoal with Sorbitol	10
2059	Tum-E-Vac + 32Fr Lavage Tubing + (1) 25g Activated Charcoal with Sorbitol + (1) 25g Activated Charcoal	10
2081	Tum-E-Vac + Universal Solution Spike + (2) 25g Activated Charcoal with Sorbitol	10



Gastric Lavage

LAVAGE TUBING

LATEX FREE | SINGLE USE | DISPOSABLE

Ethox

Radiopaque strip confirms proper tube placement

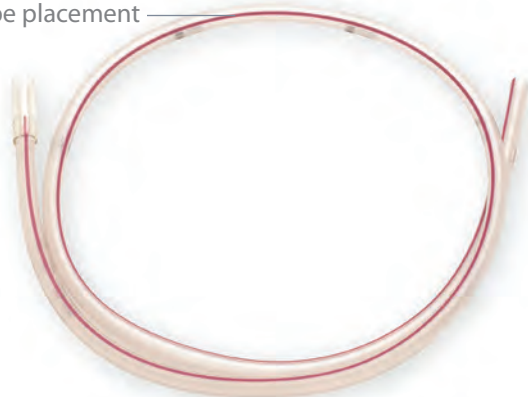

Reference marks at 18", 20" and 22" from distal end



- Open bullet tip design with multiple eyelets to create free-flowing movement with low resistance
- Soft clear tube with smooth tip
- Suction connector on proximal end
- Radiopaque stripe
- All tubing is 48" long with reference marks at 18", 20" and 22" from distal end
- Individually packaged

CAT#	SIZE	DESCRIPTION	PK
2124	24Fr	48" Lavage Tubing	10
2128	28Fr	48" Lavage Tubing	10
2132	32Fr	48" Lavage Tubing	10
2136	36Fr	48" Lavage Tubing	10

Airway Accessory

JAW SPREADER

LATEX FREE | SINGLE USE | DISPOSABLE

SunMed



- Helps facilitate breathing during convulsions or seizures
- Universal design firmly holds the tongue down while keeping jaw open in both children and adults
- Dependable, durable construction – will not break or splinter even under extreme pressure

CAT#	KIT INCLUDES
9-3042-00	Jaw Spreader (fits children and adults), Bite Block, Pediatric Berman Airway (6cm), Adult Berman Airway (9cm), Case

Patient Safety

BITE BLOCK

LATEX FREE | SINGLE USE | DISPOSABLE

Ethox



- Assists with naso-gastric tube placement
- Accommodates up to a 40Fr tube
- Individually packaged

CAT#	DESCRIPTION	PK
2060	Bite Block	50



Wound Irrigation

COMBIPORT® + COMBIGUARD II®

LATEX FREE | STERILE | SINGLE PATIENT USE | DISPOSABLE

Ethox



The Combiguard II attaches to a syringe (or Combiport) to assist in wound cleansing

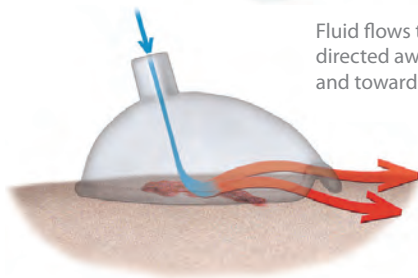

Fluid flows through angled port, directed away from cleansed area and toward the outlet ports



Combiguard II + Combiport

Working together, a saline bag uses a Combiport attached to a Combiguard II to effectively cleanse the wound without splashback on the caregiver

COMBIGUARD II® IRRIGATION SPLASH GUARD

- Egg-shaped cup covers wound site to prevent irrigation splashback, helping to protect clinician
- Dual outlet ports enable contaminated fluids to safely escape
- Fluid delivery inlet delivers a stream equivalent to an 18g needle
- Angled delivery inlet directs fluid away from cleansed area toward outlet ports
- Rounded edges provide a smooth surface against the skin
- Fits on 30-40cc luer-tipped syringe
- Can be combined with Combiport Wound Irrigation Device



COMBIPORT® WOUND IRRIGATION DEVICE

- Attaches to a standard saline bag to administer a high volume of fluid in a short period of time
- Irrigation helps remove foreign bodies, reduce pathogen numbers and moisten wound tissue
- Patented spike attaches to standard 500ml or 1000ml saline bag
- For use only with Combiguard Irrigation Splash Guard (not sold separately)
- Removable cap for easy stop/start during cleansing
- Easy to assemble and use



STERILE

CAT#	DESCRIPTION	PK
10222	Combiguard II® Irrigation Splash Guard	50
10100	Combiguard II® + Combiport®	50

NON-STERILE

CAT#	DESCRIPTION	PK
10222NS	Combiguard II® Irrigation Splash Guard Non-Sterile	500



Medication Delivery

INFU-SURG® PRESSURE INFUSION BAG

LATEX FREE | SINGLE PATIENT USE | DISPOSABLE

Ethox



- Ideal for intravenous and intra-arterial infusion treatment including A-line pressure monitoring
- Pressure relief valve prevents over inflation (330mmHg pressure relief)
- Large, oval shaped bulb allows for quick and easy inflation of bladder
- Single-handed inflation and deflation design makes it easy to use and requires minimal training
- Dedicated fluid bag hook enables efficient loading and unloading of the system without having to remove the infusion bag from the IV pole
- Suitable for use with external inflation sources
- Color-coded gauge makes for accurate pressure monitoring (0-300mmHg)
- Three-way stopcock ensures precise control of pressure
- Incredibly reliable – 100% tested



Three-way stopcock ensures precise control of pressure while the large oval bulb allows for quick bladder inflation, all with ONE hand



Solution bag hook enables easy bag changing without having to remove the Infu-Surg from the IV pole; keeps fluid bag in proper position while in use



360° view of the color-coded gauge facilitates accurate pressure monitoring while the safety pressure relief valve prevents over-inflation

CAT#	VOLUME	DESCRIPTION	PK
4005H	500ml	Infu-Surg® with Hook	25
4010H	1000ml	Infu-Surg® with Hook	25
4030	3000ml	Infu-Surg®	25



Forceps

OPEN MAGILL FORCEPS

LATEX FREE

SunMed



- Surgical stainless steel

CAT#	SIZE	DESCRIPTION	PK
9-3016-02	Child, 4.5"	Open Magill Forceps	1
9-3016-03	Adult, 5.5"	Open Magill Forceps	1

Instruments

TONGUE SEIZING FORCEPS

LATEX

SunMed



- Surgical stainless steel
- Includes latex rubber tips

CAT#	SIZE	DESCRIPTION	PK
9-3021-50	3"	Tongue Seizing Forceps	1
9-3021-52	-	Latex Replacement Tips	1 pair

Forceps

CLOSED MAGILL FORCEPS

LATEX FREE

SunMed



- Surgical stainless steel

CAT#	SIZE	DESCRIPTION	PK
9-3018-01	Infant, 3"	Closed Magill Forceps	1
9-3018-02	Child, 4"	Closed Magill Forceps	1
9-3018-03	Adult, 5"	Closed Magill Forceps	1

Mask

CPR POCKET MASK

STERILE | LATEX FREE | SINGLE PATIENT USE | DISPOSABLE

SunMed



- Designed with breathing filter and one-way valve

CAT#	DESCRIPTION	PK
8-5070-03	CPR Pocket Mask with Large Filter and One-way Valve	1



Stethoscope
SPRAGUE

LATEX FREE

SunMed



- Three different size bells eliminates the need for multiple stethoscopes for infants, children and adults
- Various heads for acoustical responses in low, medium and high pitch sounds
- Heavy wall 22" tubing and choice of ear tips help reduce sound leakage and extraneous noise
- Complete stethoscope kit includes 1 pair black plastic ear tips, 3 open bells (infant, child, adult), 1 pair soft rubber (mushroom type) ear tips, adult and pediatric diaphragms
- 29" Overall length

Stethoscope
DUAL HEAD

LATEX FREE

SunMed



- Molded one piece Y tubing
- High sensitivity - lightweight diaphragm
- Non-chill ring
- Anodized aluminum chestpiece
- Chrome plated brass binaurals
- White plastic eartips
- Superior acoustics
- 31" Overall length

CAT#	DESCRIPTION	PK
6-0028-00	Sprague Rappaport Stethoscope	1

CAT#	DESCRIPTION	COLOR	PK
6-0027-40	Dual Head Stethoscope	Black	1
6-0027-41	Dual Head Stethoscope	Red	1
6-0027-42	Dual Head Stethoscope	Grey	1
6-0027-43	Dual Head Stethoscope	Green	1



OXYGEN DELIVERY



143-147 O2 Flow Meter

143-147 Cannula

148-149 Mask

151 Circuit

SunMed

Ventlab

Ethox

Oxygen Flow Meter
TRU-FLOW™

LATEX FREE | REUSABLE



- Lexan® inner calibrated flow tube has a lifetime warranty on calibration and manufacturing defects
- 50 psi auxiliary power take-off and double unit configurations available
- Fine-threaded needle valve provides precise gas flow control



Flow Meter with Adapter



Flow Meter with Take Off



Flow Meter Double

HAND NUT INLET

CAT#	DESCRIPTION	PK
8-8151-04	Oxygen 0-15 LPM with Adapter	1
8-8153-04	Oxygen 0-15 LPM Take Off	1
8-8154-04	Oxygen 0-15 LPM Double	1

OHMEDA INLET

CAT#	DESCRIPTION	PK
8-8151-07	Oxygen 0-15 LPM with Adapter	1
8-8153-07	Oxygen 0-15 LPM Take Off	1
8-8154-07	Oxygen 0-15 LPM Double	1

CHEMETRON INLET

CAT#	DESCRIPTION	PK
8-8151-09	Oxygen 0-15 LPM with Adapter	1
8-8153-09	Oxygen 0-15 LPM Take Off	1
8-8154-09	Oxygen 0-15 LPM Double	1

ADAPTER FREE INLET

CAT#	DESCRIPTION	PK
8-8151-01	Oxygen 0-15 LPM 1/8" NPT Female Inlet	1

Oxygen Delivery
CHRISTMAS TREE CONNECTOR

LATEX FREE | SINGLE USE | DISPOSABLE



- USA Green oxygen color indicator
- One-piece connector has no loose parts
- Two-piece connector may be rotated while tubing is attached

CAT#	DESCRIPTION	PK
8-2311-20	One-Piece Oxygen Nut + Stem	50
8-2311-50	Two-Piece Oxygen Nut + Stem	50

Oxygen Delivery
WRENCH

LATEX FREE



- Metal wrench boasts durability and long life
- Plastic wrench is lightweight and economical

CAT#	DESCRIPTION	PK
7-9900-02	Metal Wrench For E & D Cylinders	1
7-9900-13	Plastic Wrench For E & D Cylinders	1



Oxygen Cannula

O₂ CANNULA

LATEX FREE | SINGLE PATIENT USE | DISPOSABLE

Ventlab



1107
Adult O₂ Cannula / FRONT DETAIL



1107
Adult O₂ Cannula / BACK DETAIL

- Curved nares made of ultra-soft material for optimum patient comfort
- 3-Channel tubing prevents kinking
- Fits-All Connector available
- Supply tubing available, 4'- 25' lengths

FITS-ALL CONNECTOR

CAT#	DESCRIPTION	LENGTH	PK
1400F	Neonate O ₂ Cannula	none	50
1407F	Neonate O ₂ Cannula	7'	50
1300F	Infant O ₂ Cannula	none	50
1307F	Infant O ₂ Cannula	7'	50
1315F	Infant O ₂ Cannula	15'	50
1200F	Pediatric O ₂ Cannula	none	50
1207F	Pediatric O ₂ Cannula	7'	50
1215F	Pediatric O ₂ Cannula	15'	50
1007F	Adult O ₂ Cannula (with tab)	7'	50
1100F	Adult O ₂ Cannula	none	50
1104F	Adult O ₂ Cannula	4'	50
1107F	Adult O ₂ Cannula	7'	50
1115F	Adult O ₂ Cannula	15'	50
1125F	Adult O ₂ Cannula	25'	50

STANDARD CONNECTOR

CAT#	DESCRIPTION	LENGTH	PK
1400	Neonate O ₂ Cannula	none	50
1407	Neonate O ₂ Cannula	7'	50
1300	Infant O ₂ Cannula	none	50
1307	Infant O ₂ Cannula	7'	50
1315	Infant O ₂ Cannula	15'	50
1200	Pediatric O ₂ Cannula	none	50
1207	Pediatric O ₂ Cannula	7'	50
1215	Pediatric O ₂ Cannula	15'	50
1007	Adult O ₂ Cannula (with tab)	7'	50
1100	Adult O ₂ Cannula	none	50
1104	Adult O ₂ Cannula	4'	50
1107	Adult O ₂ Cannula	7'	50
1115	Adult O ₂ Cannula	15'	50
1125	Adult O ₂ Cannula	25'	50



Oxygen Cannula

O₂ DEMAND CANNULA

LATEX FREE | SINGLE PATIENT USE | DISPOSABLE

Ventlab



Demand O₂ Cannula
FRONT DETAIL



Demand O₂ Cannula
BACK DETAIL

- Straight nares made of ultra-soft material for optimum patient comfort
- 3-Channel tubing prevents kinking
- Supply tubing available, 4'- 7' lengths

CAT#	DESCRIPTION	LENGTH	PK
4144	Adult Demand Cannula	4'	25
4145	Adult Demand Cannula	5'	25
4147	Adult Demand Cannula	7'	25

Oxygen Cannula

HIGH FLOW O₂ CANNULA

LATEX FREE | SINGLE PATIENT USE | DISPOSABLE

Ventlab



High Flow O₂ Cannula
FRONT DETAIL



High Flow O₂ Cannula
BACK DETAIL

Fits-All Connector



- Curved nares made of ultra-soft material for optimum patient comfort
- 3-Channel tubing which prevents kinking
- Green supply tubing standard, 4'- 15' lengths
- All versions include Fits-All Connector



CAT#	DESCRIPTION	LENGTH	PK
1104HF	Adult High Flow Cannula	4'	25
1104HFC	Adult High Flow Cannula	4' <i>Clear Tubing</i>	25
1107HF	Adult High Flow Cannula	7'	25
1115HF	Adult High Flow Cannula	15'	25



Humidification

BUBBLE HUMIDIFIER

LATEX FREE | SINGLE USE | DISPOSABLE

Ventlab



- 6-15LPM
- Features 6 PSI (414 mbar) pressure relief valve

CAT#	DESCRIPTION	PK
6900	Bubble Humidifier	10

Oxygen Cannula

HIGH FLOW O₂ CANNULA + HUMIDIFIER

LATEX | SINGLE PATIENT USE | DISPOSABLE

Ventlab



- High flow bubble humidifier, 6-15LPM
- Humidifier features 6 PSI (414 mbar) pressure relief valve
- Curved nares made of ultra-soft material for optimum patient comfort
- 3-Channel tubing which prevents kinking
- Green supply tubing standard
- Cannula features Fits-All Connector

CAT#	DESCRIPTION	LENGTH	PK
6907	Humidifier + Adult Cannula	7'	10
6915	Humidifier + Adult Cannula	15'	10



FOR COMPLETE
Customer Service
Technical Information
Care/Cleaning Instructions
Product Literature

CALL
800-433-2797

VISIT
www.Sun-Med.com

EMAIL
info@Sun-Med.com

End Tidal Cannula

ETCO₂ CANNULA

LATEX FREE | SINGLE PATIENT USE | DISPOSABLE

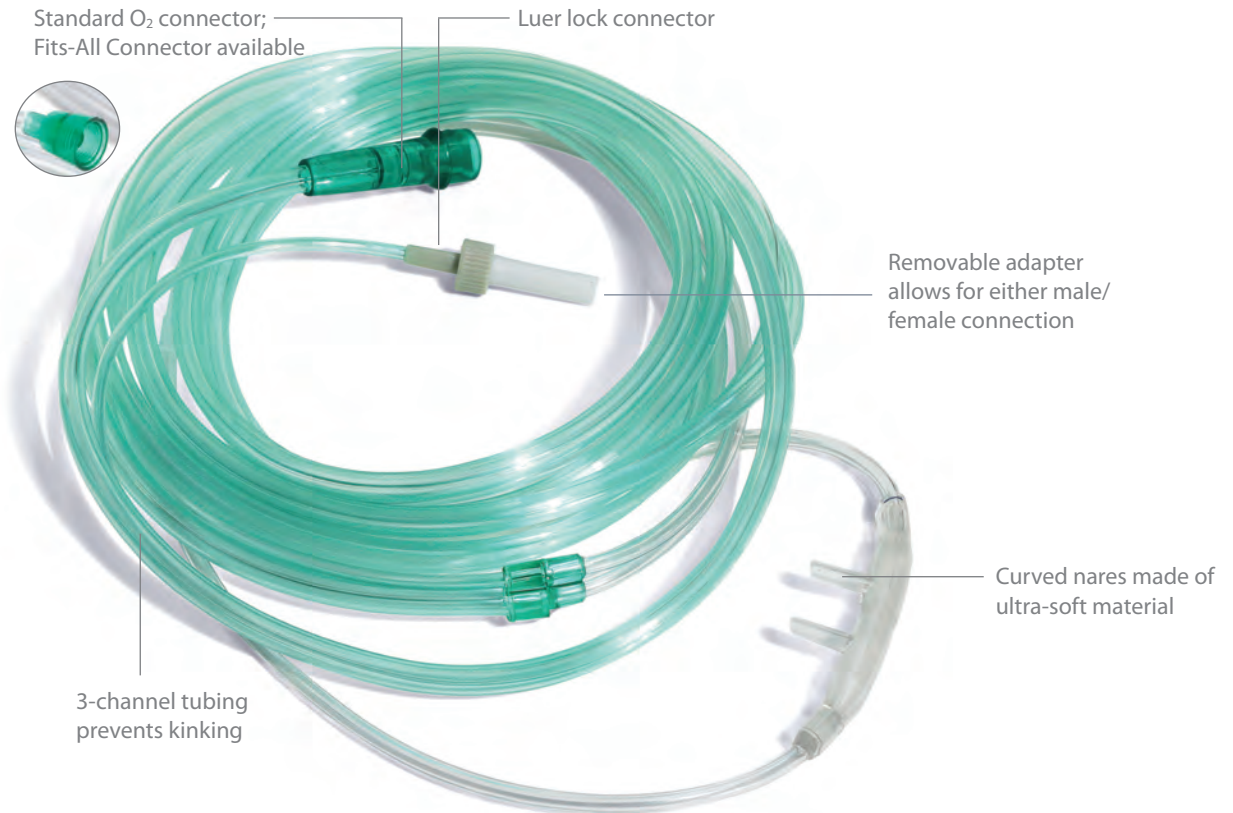

- Delivers oxygen while capturing an end tidal gas sample, even with simultaneous insufflation of oxygen
- Designed help lessen attenuation of the end tidal sample by oxygen dilution
- Dual nasal cannula simultaneously provides oxygen to both nostrils while obtaining CO₂ sampling during spontaneous breathing
- Designed to prevent mixing of fresh oxygen with CO₂
- 3-Channel tubing prevents kinking
- Includes male/female adapter with luer lock connector
- Available in three tubing lengths

SIMULTANEOUSLY DELIVERS OXYGEN + CAPTURES ETCO₂ SAMPLE



Adult ETCO₂ Cannula
DETAIL

FITS-ALL CONNECTOR

CAT#	DESCRIPTION	LENGTH	PK
4107F	Adult ETCO ₂ Cannula	7'	25
4110F	Adult ETCO ₂ Cannula	10'	25
4114F	Adult ETCO ₂ Cannula	14'	25

STANDARD CONNECTOR

CAT#	DESCRIPTION	LENGTH	PK
4107	Adult ETCO ₂ Cannula	7'	25
4110	Adult ETCO ₂ Cannula	10'	25
4114	Adult ETCO ₂ Cannula	14'	25



End Tidal Cannula

ETCO₂ CANNULA + SCOOP

LATEX FREE | SINGLE PATIENT USE | DISPOSABLE

Ventlab

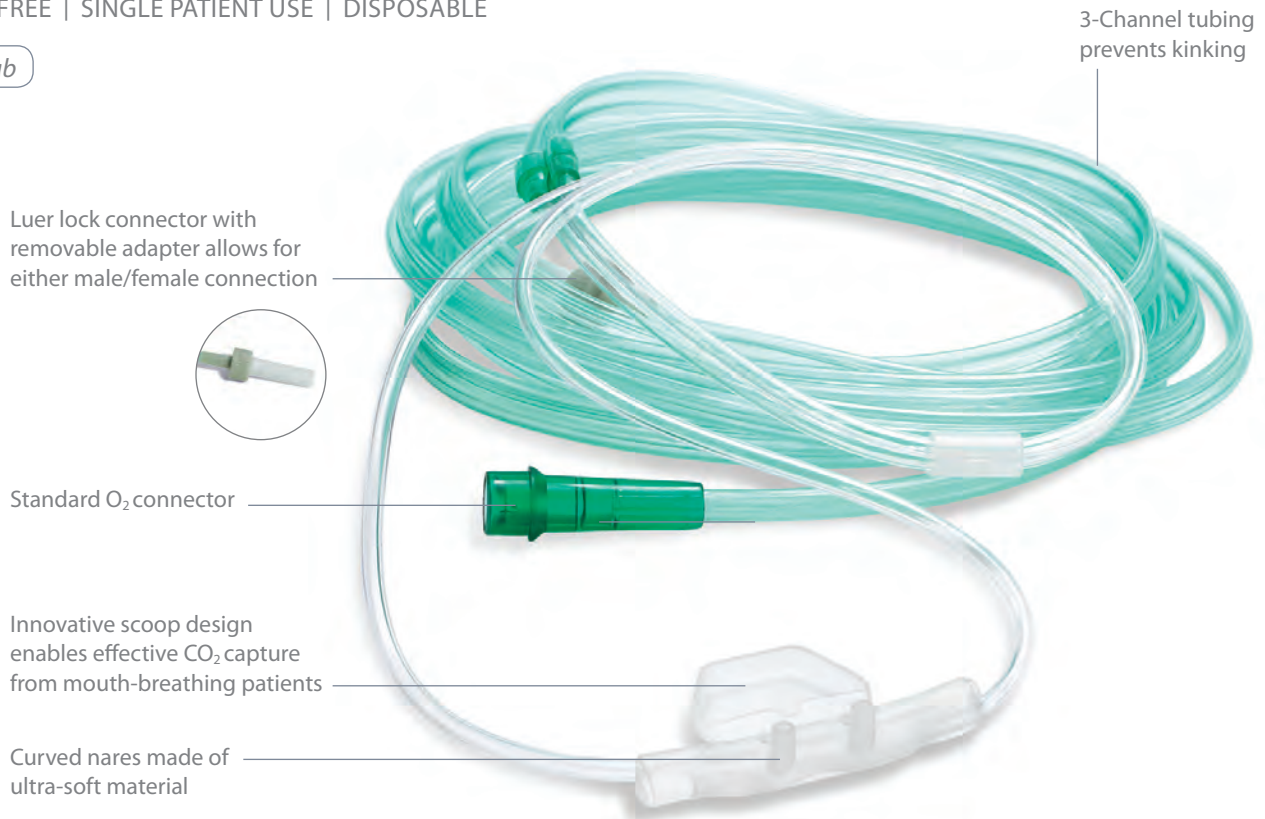

- Innovative design suitable for mouth-breathing patients
- Dual nasal cannula simultaneously provides oxygen to both nostrils while obtaining CO₂ sampling during spontaneous breathing
- Strategically positioned holes deliver O₂, and CO₂ is effectively captured through the nares and scoop
- Designed to prevent mixing of fresh oxygen with CO₂
- Designed to help lessen attenuation of the end tidal sample by oxygen dilution, particularly for mouth-breathing patients
- 3-Channel tubing prevents kinking
- Includes male/female adapter with luer lock connector
- Available in three tubing lengths

UNIQUE SCOOP DESIGN FACILITATES CO₂ CAPTURE IN MOUTH-BREATHING PATIENTS

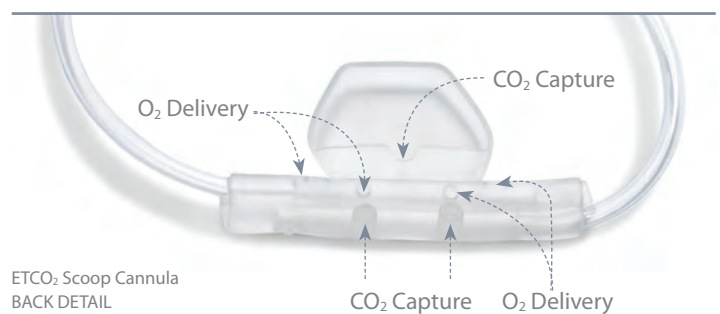

CAT#	DESCRIPTION	LENGTH	PK
4707	Adult ETCO ₂ Cannula	7'	25
4710	Adult ETCO ₂ Cannula	10'	25
4714	Adult ETCO ₂ Cannula	14'	25



Oxygen Mask

HIGH CONCENTRATION

LATEX FREE | SINGLE PATIENT USE | DISPOSABLE

Ventlab



2201
Partial Non-Rebreather



2102
Partial Non-Rebreather

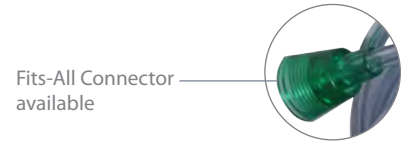

Fits-All Connector
available

- Delivers high concentration of oxygen
- Reservoir bag assures oxygen supply to meet variable breathing patterns and tidal volumes
- Soft, pliable mask fits comfortably on patient
- Includes elastic head strap for best fit
- Transparent PVC mask enables clear visualization of patient
- Swivel connector design ensures uninterrupted flow of oxygen from the bag to the patient
- All sizes include 7' 3-channel oxygen tubing
- Pliable nose clip helps keep mask in place
- Available as non-rebreather or partial non-rebreather
- Designed with two valves on the non-rebreather; one on the partial non-rebreather

PARTIAL NON-REBREATHING ONE VALVE

CAT#	SIZE	DESCRIPTION	PK
2101	Adult	Partial Non-Rebreathing	50
2101F	Adult	Partial Non-Rebreathing + Fits-All Connector	50
2201	Pediatric	Partial Non-Rebreathing	50
2201F	Pediatric	Partial Non-Rebreathing + Fits-All Connector	50
2301	Infant	Partial Non-Rebreathing	50
2301F	Infant	Partial Non-Rebreathing + Fits-All Connector	50

NON-REBREATHING TWO VALVES

CAT#	SIZE	DESCRIPTION	PK
2102	Adult	Non-Rebreathing	50
2102F	Adult	Non-Rebreathing + Fits-All Connector	50
2202	Pediatric	Non-Rebreathing	50
2202F	Pediatric	Non-Rebreathing + Fits-All Connector	50
2302	Infant	Non-Rebreathing	50
2302F	Infant	Non-Rebreathing + Fits-All Connector	50



Oxygen Mask

MEDIUM CONCENTRATION

LATEX FREE | SINGLE PATIENT USE | DISPOSABLE

Ventlab

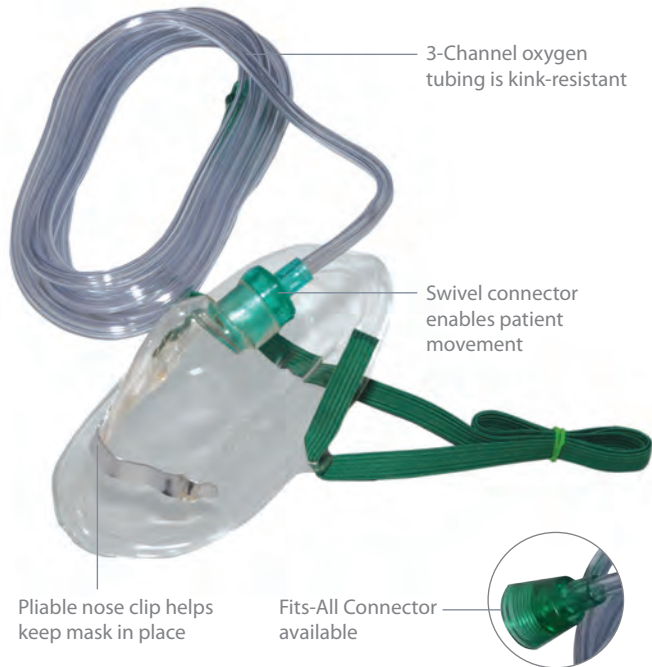

- Flow rate of 6-10 liters per minute
- Delivers an oxygen concentration of 40% to 50% based on breathing rate and tidal volume
- Soft, pliable mask fits comfortably on patient
- Includes elastic head strap for best fit
- Transparent PVC mask enables clear visualization of patient
- O₂ Inlet designed to direct oxygen into the nostrils rather than up toward eyes
- All sizes include 7' 3-Channel oxygen tubing
- Pliable nose clip helps keep mask in place
- Swivel connector enables patient rotation and movement without discomfort

FITS-ALL CONNECTOR

CAT#	SIZE	DESCRIPTION	PK
2100F	Adult	Medium Concentration	50
2200F	Pediatric	Medium Concentration	50
2300F	Infant	Medium Concentration	50

STANDARD CONNECTOR

CAT#	SIZE	DESCRIPTION	PK
2100	Adult	Medium Concentration	50
2200	Pediatric	Medium Concentration	50
2300	Infant	Medium Concentration	50

Oxygen Tubing

OXYGEN TUBING

LATEX FREE | SINGLE PATIENT USE | DISPOSABLE

Ventlab



- Available in clear or semi-transparent green
- Six lengths available
- Three-channel tubing design prevents kinking

GREEN TUBING

CAT#	DESCRIPTION	LENGTH	PK
3007G	Oxygen Supply Tubing	7'	50
3015G	Oxygen Supply Tubing	15'	50
3025G	Oxygen Supply Tubing	25'	25
3040G	Oxygen Supply Tubing	40'	20
3050G	Oxygen Supply Tubing	50'	20

CLEAR TUBING

CAT#	DESCRIPTION	LENGTH	PK
3004	Oxygen Supply Tubing	4'	50
3007	Oxygen Supply Tubing	7'	50
3007F	Oxygen Supply Tubing + Fits All	7'	50
3015	Oxygen Supply Tubing	15'	50
3025	Oxygen Supply Tubing	25'	25
3040	Oxygen Supply Tubing	40'	20
3050	Oxygen Supply Tubing	50'	20

Cannula + Circuit Organizer

TUBE TREE

LATEX FREE

SunMed

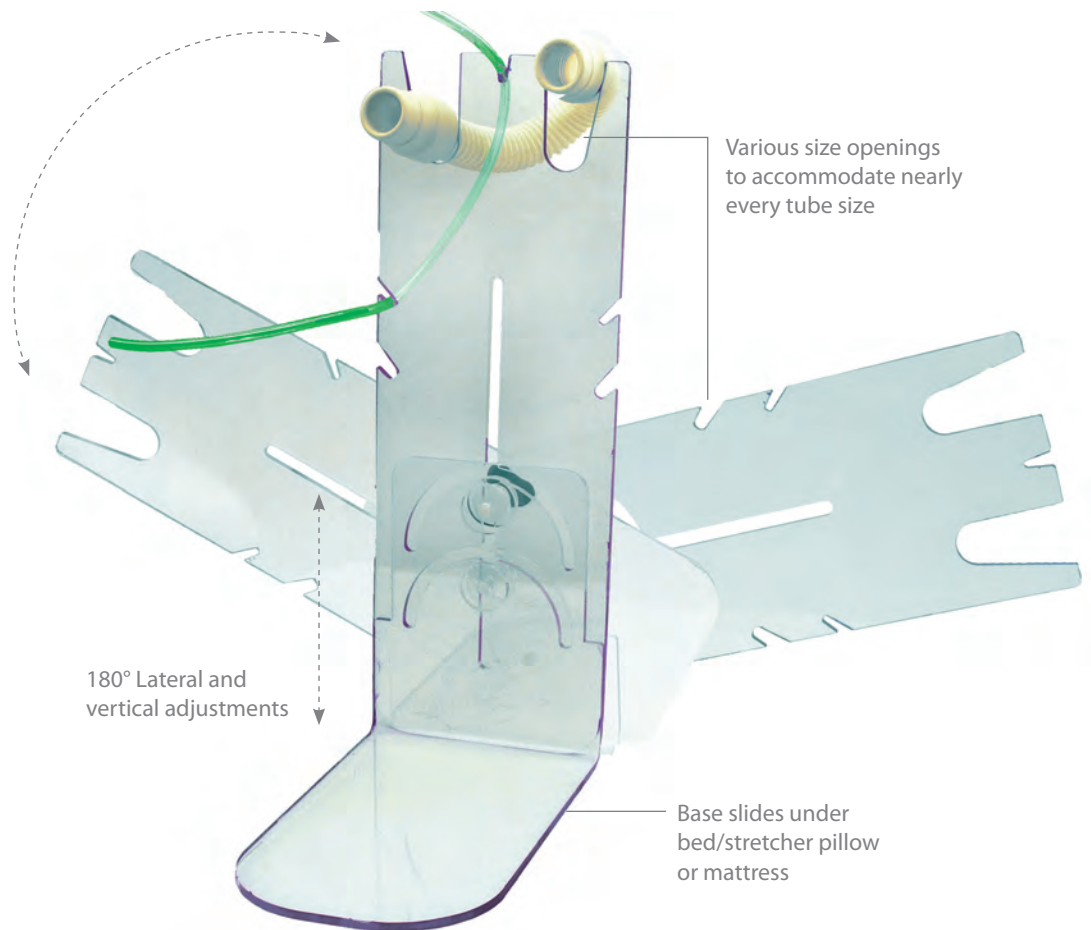

8-0038-04

- Easily restrain oxygen and suction tubing, gas sampling lines
- Effectively manage all three diameter breathing hoses: small disposable plastic, medium reusable rubber and plastic, large king hoses
- Available in stainless steel or clear polycarbonate (PC) for long life
- PC models are more durable than acrylic and can be safely cleaned with alcohol
- PC models accommodate gas sampling tubes
- PC models safe for MRI use
- Each model measures 12.125"H x 5"W x 8.5"D



8-0038-03



8-0038-01

CAT#	DESCRIPTION	PK
8-0038-01	Stainless Steel Tube Tree	1
8-0038-03	Polycarbonate Tube Tree	1
8-0038-04	Adjustable Polycarbonate Tube Tree	1



Breathing Circuit
MRI CIRCUIT

LATEX FREE | SINGLE PATIENT USE | DISPOSABLE

Ventlab

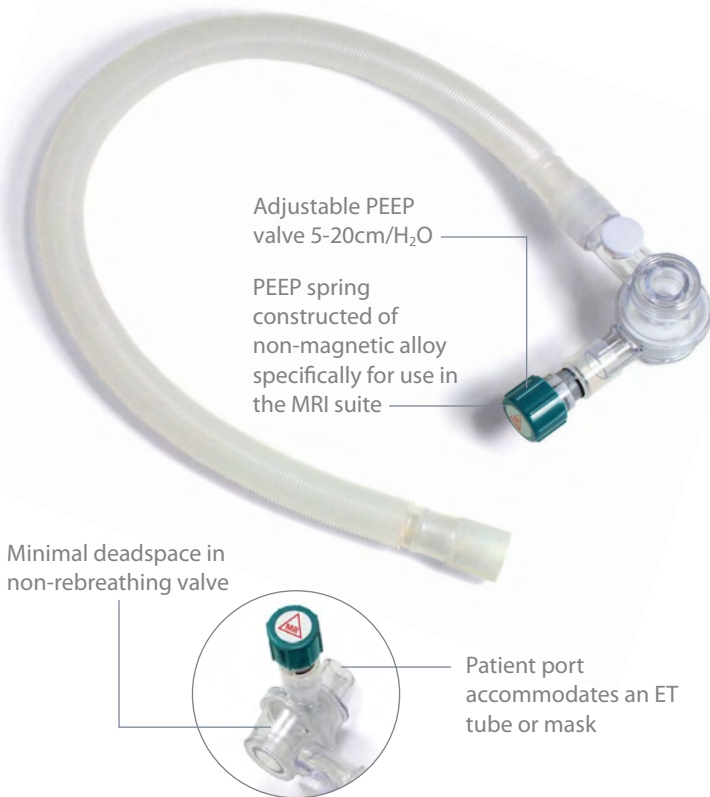

- Patient valve, PEEP valve and oxygen tubing constructed of MRI-safe materials
- 3 o'clock position of PEEP keeps valve out of patient's face
- For use with Smiths Medical PneuPac and other ventilators
(Consult ventilator manufacturer specifications prior to use)
- Corrugating tubing expands generously to 9' for easier ventilation management during procedures
- Circuit available with or without PEEP valve



CAT#	DESCRIPTION	PK
VC1000	MRI Transport Circuit + PEEP Valve	10
VC1000F	MRI Transport Circuit + PEEP Valve + Filter	10
VC1010	MRI Transport Circuit	10
VC1010F	MRI Transport Circuit + Filter	10
VP705	19mm MRI Safe Adjustable PEEP Valve	20

Breathing Circuit
STANDARD CIRCUIT

LATEX FREE | SINGLE PATIENT USE | DISPOSABLE

Ventlab



- Use as a conduit for gases between a Resprionics® positive pressure generator and a patient during non-invasive ventilation
- 72" smooth bore tubing with pressure monitoring line and dual ported adapter
- 24" extension tubing with T-assembly for dual pressure monitoring

CAT#	DESCRIPTION	PK
RC1000	Standard Circuit + 22mm OD Adapter	10



FOR COMPLETE
Customer Service
Technical Information
Care/Cleaning Instructions
Product Literature

CALL
800-433-2797

VISIT
www.Sun-Med.com

EMAIL
info@Sun-Med.com

DIAGNOSTICS



154-157 Diagnostic Devices

158-159 Stethoscopes

160-161 ETCO2 Cannulas

SunMed

Ventlab

Ethox

Peripheral Nerve Stimulator

SUNSTIM PERIPHERAL NERVE STIMULATOR

LATEX FREE

SunMed



- Delivers reliable, adjustable current in one-second twitch pulses
- Features built-in train of four with four pulses per two seconds
- Stimulator output current is fully adjustable from 0-70 mA
- **SunStim™ (8-1053-60) Switch functions:**
 - Stand-by position: no stimulus pulses are generated
 - Twitch: 1 pulse per second
 - Tetanus: 100 Hz (100 pulses/s)
 - Built-in train of four: 4 pulses in a period of 2 seconds
- **SunStim™ Plus (8-1053-62) Switch functions:**
 - Double burst: 2 60-ms bursts of 50 Hz separated by .75s
 - Twitch: 1 pulse per second
 - Tetanus: 50 Hz (50 pulses/s) or 100 Hz (100 pulses/s)
 - Built-in train of four: 4 pulses in a period of 2 seconds
 - Stimulus pulse: square wave monophasic pulses (200- μ s duration)
- Both units include instruction manual, ball electrodes, battery and 6' lead wires with alligator clips
- Pole mount bracket enables easy storage and retrieval from IV pole; works on both models.
- Battery indicator light flashes when battery needs to be replaced
- LED (green) battery light indicates that the unit is on, flashes on low battery
- LED (red) flashes with audible indicator sounds each time a stimulus pulse is generated
- Lightweight: 0.25lbs including battery
- Standard battery: 9 volt alkaline



PERIPHERAL NERVE STIMULATOR

CAT#	DESCRIPTION	PK
8-1053-60	SunStim™ Peripheral Nerve Stimulator	1
8-1053-62	SunStim™ Plus Peripheral Nerve Stimulator	1

ACCESSORIES

CAT#	DESCRIPTION	PK
8-1053-85	Pole Mount Bracket	1
8-1053-76	Ball Electrode and Hollow Pin	1
8-1051-78	6' Lead, Snap and Shielded Pin	1
8-1051-79	6' Lead, Clip and Shielded Pin	1



Oximeter

FINGERTIP PULSE OXIMETER

LATEX FREE

SunMed



- Accurately displays patient O₂ saturation and pulse rate using high readability OLED display technology
- SPO₂ measurement from 70-99%; accuracy 80-90% +/- 2%
- Pulse rate measurement 30-225 BPM, +/- 2BPM, 100-235 BPM +/- 2%
- AAA battery life of up to 30 hours; auto shut-off feature, low power indicator, 10 brightness scales
- Includes lanyard, protective cover and carrying pouch
- Convenient pocket size: 2" x 1.25" x 1.375"; wt. 1.2 oz.

CAT#	DESCRIPTION	PK
9-6001-00	Fingertip Pulse Oximeter	1

Diagnostics

DIAGNOSTIC KIT

LATEX FREE

SunMed



Complete kit includes:

- Ear tips in sizes 2.5 and 3.5
- Disposable ear tips in sizes 4.5mm and 4mm (with adapters)
- Nasal speculum screw type
- Ophthalmoscope head
- Otoscope chamber
- Metal tongue depressor
- Illuminated tongue holder
- Laryngeal mirrors sizes 3 and 4
- Tongue holder for wooden blades
- Battery handle (requires two "C" batteries; not included)

CAT#	DESCRIPTION	PK
9-7005-00	Diagnostic Kit	1



FOR COMPLETE
Customer Service
Technical Information
Care/Cleaning Instructions
Product Literature

CALL
800-433-2797
VISIT
www.Sun-Med.com
EMAIL
info@Sun-Med.com

Diagnostics
OTOSCOPE

LATEX FREE

SunMed



- Complete with otoscope chamber, battery handle and ear tips in sizes 2.5, 3.5, and 4.5mm
- Chrome plated brass handle
- Ear tips are reusable and autoclavable
- Packed in a zippered pouch
- Adapter available for use with Welch Allyn disposable specula tips
- Requires two "C" batteries; not included

CAT#	DESCRIPTION	PK
9-7004-20	Otoscope	1
9-7004-05	Adapter for Welch Allyn Disposable Specula Tips	1

CO₂ Indicator
STAT CHECK

LATEX FREE

Ventlab



Color indication of CO₂ Presence
 0% CO₂ PRESENT (Purple) 5% CO₂ PRESENT (Yellow)
 → Active Resuscitation / Ventilation



- Verifies CO₂ exchange during resuscitation
- Helps confirm proper ET tube placement
- Three color scale enables clear visualization of CO₂ exchange
- A simple twist removes the cap and immediately activates CO₂ detection

CAT#	DESCRIPTION	PK
SC200	STAT-Check CO ₂ Indicator	10



FOR COMPLETE
 Customer Service
 Technical Information
 Care/Cleaning Instructions
 Product Literature

CALL
 800-433-2797
VISIT
www.Sun-Med.com
EMAIL
info@Sun-Med.com



Accessory

PEAK FLOW METER

LATEX FREE | SINGLE USE | DISPOSABLE

SunMed



- Economical self-monitoring tool to provide and track information about patient's response to treatment
- Includes patient use instructions and chart
- Ideal for use with asthma, chronic bronchitis and emphysema cases
- Standard Mini-Wright is tubular, with a spring-loaded piston and a longitudinal slot through which air escapes; scale reads from 60 to 850 liters/minute
- Low Mini-Wright monitors the low range from 30 to 400 liters/minute; correlates closely with the Standard Meter

CAT#	DESCRIPTION	SIZE	PK
8-3548-10	Standard Flow Meter	60-850 LPM	1
8-3548-15	Low Flow Meter	30-400 LPM	1

Accessory

NOSE CLIP

LATEX FREE | SINGLE PATIENT USE | DISPOSABLE

SunMed

- Ideal for use during breathing treatments with peak flow meters and pulmonary function procedures
- Large, soft nose cushions provide patient comfort

CAT#	DESCRIPTION	PK
9-0134-44	Nose Clip	100

Accessory

MOUTHPIECE

LATEX FREE | SINGLE USE | DISPOSABLE

SunMed



- Smooth interior allowing laminar flow
- Constructed of plastic for greater comfort and no cardboard taste
- Large size for standard unit
- Small size for low range unit
- For use with Mini-Write Peak Flow Meter

CAT#	DESCRIPTION	PK
8-3523-20	Large / 2.5" L x 1.1" ID x 1.2" OD	100
8-3523-24	Small / 2.5" L x .775" ID x .875" OD	100
8-3523-21	Large / 2.5" L x 1.1" ID x 1.2" OD	250
8-3523-25	Small / 2.5" L x .775" ID x .875" OD	250
8-3523-22	Large / 2.5" L x 1.1" ID x 1.2" OD	500
8-3523-26	Small / 2.5" L x .775" ID x .875" OD	500



Monoscope

COMFORT FIT SOFTEAR™

LATEX FREE | SINGLE PATIENT USE | DISPOSABLE

SunMed



- Designed specifically to address sound transmission challenges for the anesthesiologist due to the irregular and variable shape of the ear canal
- Once compressed foam earpiece is inserted, it expands slowly for a perfect, low pressure seal with the canal wall
- Sealing action enables the accurate transmission of low volume sounds
- Low pressure fit against ear canal provides maximum comfort, thus promoting more vigilant use
- Connects to esophageal stethoscopes and Wenger (precordial) chest pieces
- 4' Tubing

CAT#	DESCRIPTION	PK
6-1030-25	Comfort FIT SoftEar™ Monoscope	25

Precordial Stethoscope

CHEST PIECES

LATEX FREE

SunMed



- Durable stainless steel construction – no chrome plating to flake or peel
- Pediatric chest pieces are hollow and lightweight, with rounded, smooth chest surface, making them ideal for use with newborns and infants
- Solid Wenger chest pieces feature a relatively deep sound chamber
- All chest pieces have a luer slip male connector
- Reusable

CAT#	DESCRIPTION	SIZE	PK
6-0025-00	Newborn Chest Piece	0.875" Diameter	1
6-0025-01	Infant Chest Piece	1.125" Diameter	1
6-0025-02	Child Chest Piece	1.125" Diameter	1
6-0025-03	Adult Wenger Chest Pc	1.44" Diameter	1

Precordial Stethoscope

PRECORDIAL SET

LATEX FREE | SINGLE PATIENT USE

SunMed

- 1 each adult, child, infant, and newborn chest piece
- 8 Double adhesive disks (Also available separately)
- 1 Comfort FIT SoftEar™ disposable monoscope



CAT#	DESCRIPTION	PK
6-0025-05	Precordial Stethoscope Set	1 Set
6-0025-25	Double Adhesive Disks	100



Stethoscope
SPRAGUE

LATEX FREE



- Three different size bells eliminates the need for multiple stethoscopes for infants, children and adults
- Various heads for acoustical responses in low, medium and high pitch sounds
- Heavy wall 22" tubing and choice of ear tips help reduce sound leakage and extraneous noise
- Complete stethoscope kit includes 1 pair black plastic ear tips, 3 open bells (infant, child, adult), 1 pair soft rubber (mushroom type) ear tips, adult and pediatric diaphragms
- 29" Overall length

CAT#	DESCRIPTION	PK
6-0028-00	Sprague Rappaport Stethoscope	1

Stethoscope
DUAL HEAD

LATEX FREE



- Molded one piece Y tubing
- High sensitivity - lightweight diaphragm
- Non-chill ring
- Anodized aluminum chestpiece
- Chrome plated brass binaurals
- White plastic ear tips
- Superior acoustics
- 31" Overall length

CAT#	DESCRIPTION	COLOR	PK
6-0027-40	Dual Head Stethoscope	Black	1
6-0027-41	Dual Head Stethoscope	Red	1
6-0027-42	Dual Head Stethoscope	Grey	1
6-0027-43	Dual Head Stethoscope	Green	1

End Tidal Cannula

ETCO₂ CANNULA

LATEX FREE | SINGLE PATIENT USE | DISPOSABLE

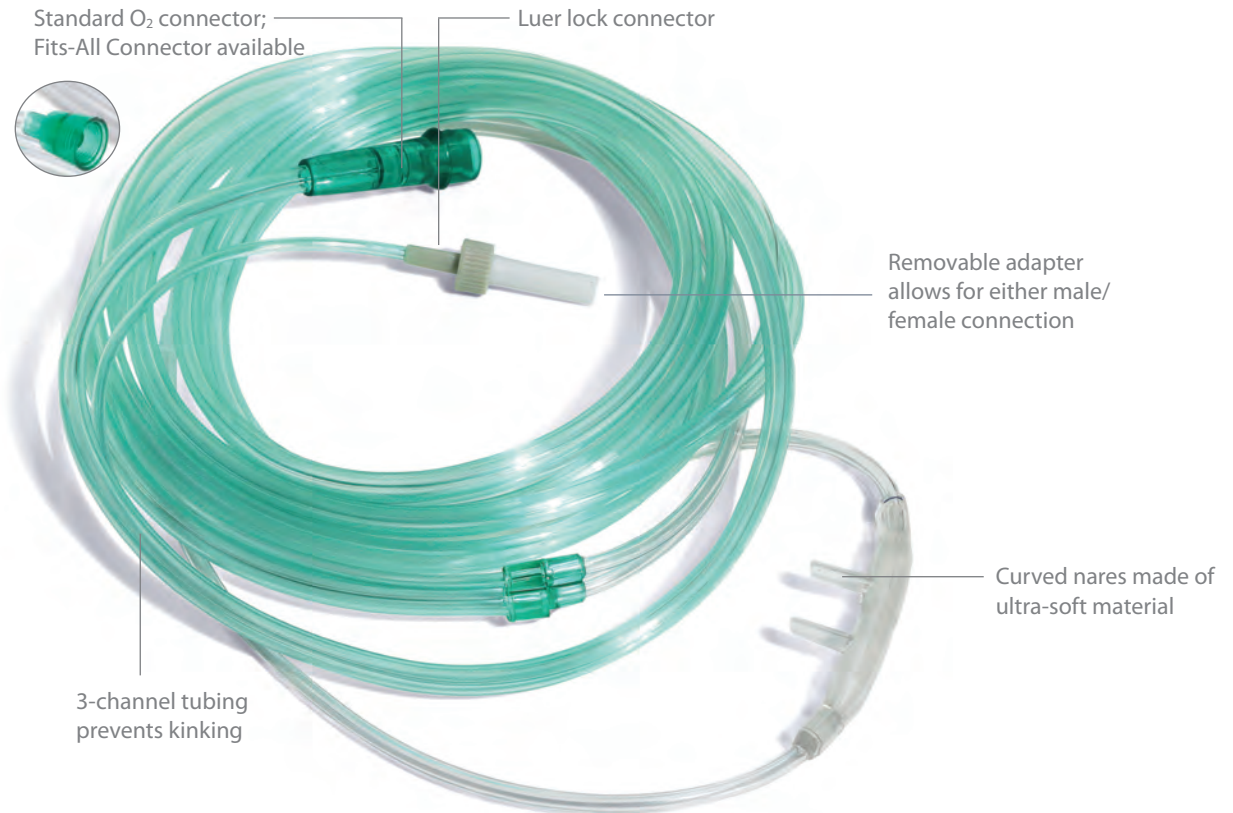

- Delivers oxygen while capturing an end tidal gas sample, even with simultaneous insufflation of oxygen
- Designed help lessen attenuation of the end tidal sample by oxygen dilution
- Dual nasal cannula simultaneously provides oxygen to both nostrils while obtaining CO₂ sampling during spontaneous breathing
- Designed to prevent mixing of fresh oxygen with CO₂
- 3-Channel tubing prevents kinking
- Includes male/female adapter with luer lock connector
- Available in three tubing lengths

SIMULTANEOUSLY DELIVERS OXYGEN + CAPTURES ETCO₂ SAMPLE



Adult ETCO₂ Cannula
DETAIL

FITS-ALL CONNECTOR

CAT#	DESCRIPTION	LENGTH	PK
4107F	Adult ETCO ₂ Cannula	7'	25
4110F	Adult ETCO ₂ Cannula	10'	25
4114F	Adult ETCO ₂ Cannula	14'	25

STANDARD CONNECTOR

CAT#	DESCRIPTION	LENGTH	PK
4107	Adult ETCO ₂ Cannula	7'	25
4110	Adult ETCO ₂ Cannula	10'	25
4114	Adult ETCO ₂ Cannula	14'	25



End Tidal Cannula

ETCO₂ CANNULA + SCOOP

LATEX FREE | SINGLE PATIENT USE | DISPOSABLE

Ventlab

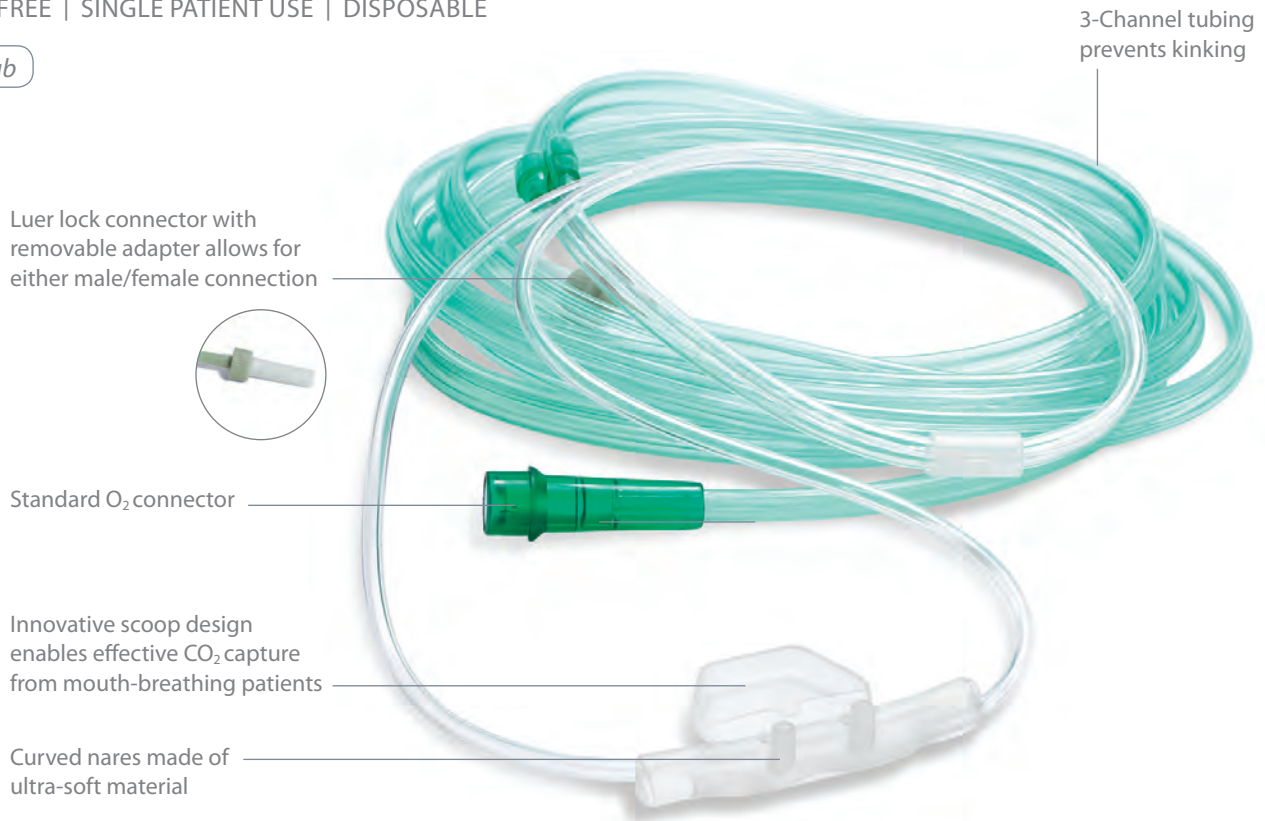

- Innovative design suitable for mouth-breathing patients
- Dual nasal cannula simultaneously provides oxygen to both nostrils while obtaining CO₂ sampling during spontaneous breathing
- Strategically positioned holes deliver O₂, and CO₂ is effectively captured through the nares and scoop
- Designed to prevent mixing of fresh oxygen with CO₂
- Designed to help lessen attenuation of the end tidal sample by oxygen dilution, particularly for mouth-breathing patients
- 3-Channel tubing prevents kinking
- Includes male/female adapter with luer lock connector
- Available in three tubing lengths

UNIQUE SCOOP DESIGN FACILITATES CO₂ CAPTURE IN MOUTH-BREATHING PATIENTS

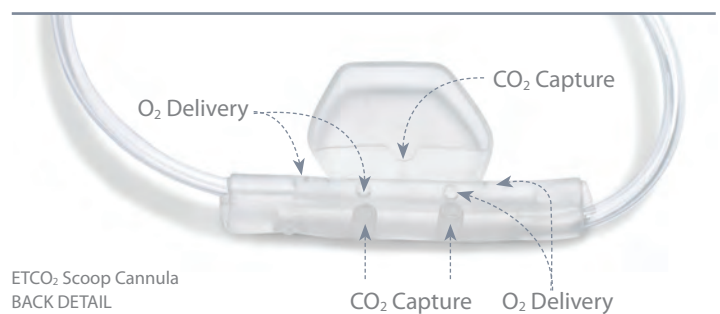

CAT#	DESCRIPTION	LENGTH	PK
4707	Adult ETCO ₂ Cannula	7'	25
4710	Adult ETCO ₂ Cannula	10'	25
4714	Adult ETCO ₂ Cannula	14'	25

SURGICAL



164-166 Surgical Accessories

167 Patient Safety

168 Instruments

169 Catheters

SunMed

Ventlab

Ethox

Instrument Holder

SURGI-KIT

LATEX FREE | STERILE | SINGLE USE | DISPOSABLE

Ethox



- Disposable pockets for sterile delivery to OR
- Keeps laparoscopic instruments close to operating field
- Maintains sterile operating field while keeping instruments within arm's reach
- Reduces time required for locating instruments
- Eliminates cleaning procedures
- Multipocket sleeves to accommodate a variety of instrument sizes
- Available with peel-n-stick tape to adhere to operating drape

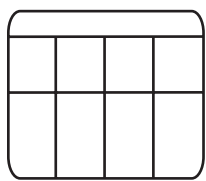

8 Pocket
SK-100
SK-100N

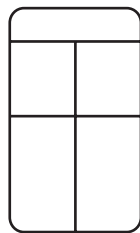

4 Pocket
SK-150
SK-150N

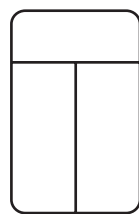

2 Pocket
SK-200
SK-200N

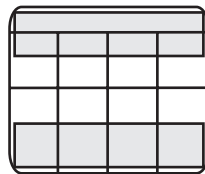

8 Pocket + Tape
SK-300
SK-300N

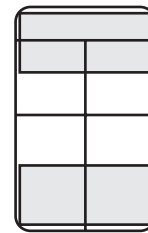

4 Pocket + Tape
SK-350
SK-350N

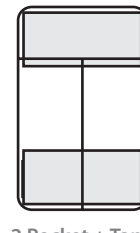

2 Pocket + Tape
SK-400
SK-400N



10 Pocket + Tape
SK-650
SK-650N

STERILE

CAT#	POCKET SIZE	DESCRIPTION	PK
SK-100	19cm x 23cm	8 pockets	50
SK-150	19cm x 11cm	4 pockets	100
SK-200	28cm x 18cm	2 pockets	50
SK-300	19cm x 23cm	8 pockets + tape	50
SK-350	19cm x 11cm	4 pockets + tape	75
SK-400	28cm x 18cm	2 pockets + tape	50
SK-650	5cm x 19cm	10 pockets + tape	50

NON-STERILE

CAT#	POCKET SIZE	DESCRIPTION	PK
SK-100N	19cm x 23cm	8 pockets	500
SK-150N	19cm x 11cm	4 pockets	500
SK-200N	28cm x 18cm	2 pockets	500
SK-300N	19cm x 23cm	8 pockets + tape	500
SK-350N	19cm x 11cm	4 pockets + tape	500
SK-400N	28cm x 18cm	2 pockets + tape	500
SK-650N	5cm x 19cm	10 pockets + tape	500



Instrument Holder

LAP-KIT

LATEX FREE | STERILE | SINGLE USE | DISPOSABLE



- Disposable pockets for sterile delivery to OR
- Keeps laparoscopic instruments close to operating field
- Maintains sterile operating field while keeping instruments within arm's reach
- Reduces time required for locating instruments
- Eliminates cleaning procedures
- Multipocket sleeves to accommodate a variety of instrument sizes
- Available with peel-n-stick tape to adhere to operating drape

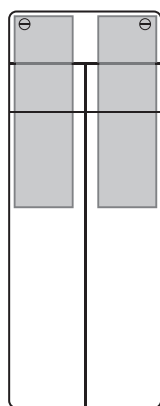

2 Pockets
LK-700
LK-700N

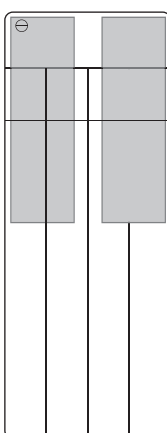

4 Pockets
LK-800

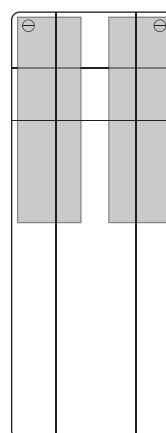

3 Pockets
LK-900
LK-900N

STERILE

CAT#	POCKET SIZE	DESCRIPTION	PK
LK-700	6.5cm x 30.5cm	2 Pockets + Tape	25
LK-800	3.2cm x 30.5cm	4 Pockets + Tape	25
LK-900	3.2cm x 30.5cm (2), 6.5cm x 30.5cm	3 Pockets + Tape	25

NON-STERILE

CAT#	POCKET SIZE	DESCRIPTION	PK
LK-700N	6.5cm x 30.5cm	2 Pockets + Tape	200
LK-900N	3.2cm x 30.5cm (2), 6.5cm x 30.5cm	3 Pockets + Tape	200



Cannula + Circuit Organizer

TUBE TREE

LATEX FREE

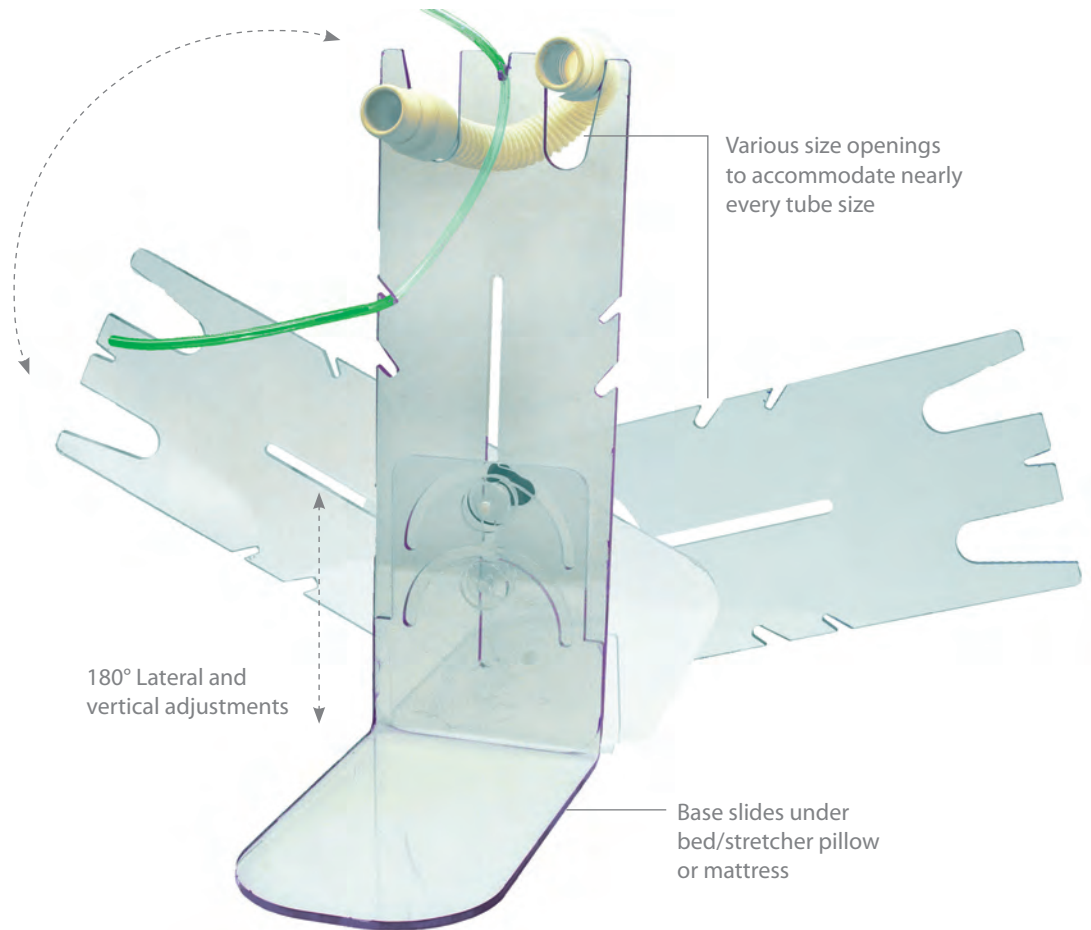

8-0038-04

- Easily restrain oxygen and suction tubing, gas sampling lines
- Effectively manage all three diameter breathing hoses: small disposable plastic, medium reusable rubber and plastic, large king hoses
- Available in stainless steel or clear polycarbonate (PC) for long life
- PC models are more durable than acrylic and can be safely cleaned with alcohol
- PC models accommodate gas sampling tubes
- PC models safe for MRI use
- Each model measures 12.125"H x 5"W x 8.5"D



8-0038-03



8-0038-01

CAT#	DESCRIPTION	PK
8-0038-01	Stainless Steel Tube Tree	1
8-0038-03	Polycarbonate Tube Tree	1
8-0038-04	Adjustable Polycarbonate Tube Tree	1



Patient Safety

IGUARD EYE PROTECTOR

LATEX FREE | STERILE | SINGLE USE | DISPOSABLE

SunMed



- Rigid, clear protective patient eye cover for use in OR, ER, and during general procedures
- Non-allergenic self-adhesive foam cushion for fast and accurate application
- Thick foam for patient comfort even in prone position
- Improved one piece backing with "courtesy tabs"

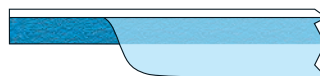

9-0210-00
Standard Foam

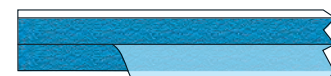

9-0210-20
Double Foam

STERILE

CAT#	DESCRIPTION	PK
9-0210-00	Adult Eye Protector	25
9-0210-21	Pediatric Eye Protector	25
9-0210-20	Double Foam Eye Protector	25

NON-STERILE

CAT#	DESCRIPTION	PK
9-0210-00I	Adult Eye Protector	25
9-0210-21I	Pediatric Eye Protector	25
9-0210-20I	Double Foam Eye Protector	25

Non-allergenic self-adhesive foam for easy application and removal

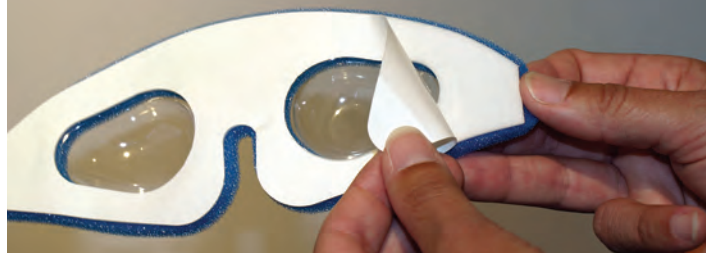

Patient Safety

TOOTH PROTECTOR

LATEX FREE | SINGLE USE | DISPOSABLE

SunMed

- Helps prevent broken or chipped teeth during intubation, bronchoscopy, laryngoscopy, tonsillectomy, and tooth extraction
- Minimizes tooth injury

CAT#	DESCRIPTION	PK
9-3041-03	Adult Tooth Protector	50



Forceps

OPEN MAGILL FORCEPS

LATEX FREE

SunMed



- Surgical stainless steel

CAT#	SIZE	DESCRIPTION	PK
9-3016-02	Child, 4.5"	Open Magill Forceps	1
9-3016-03	Adult, 5.5"	Open Magill Forceps	1

Forceps

CLOSED MAGILL FORCEPS

LATEX FREE

SunMed



- Surgical stainless steel

CAT#	SIZE	DESCRIPTION	PK
9-3018-01	Infant, 3"	Closed Magill Forceps	1
9-3018-02	Child, 4"	Closed Magill Forceps	1
9-3018-03	Adult, 5"	Closed Magill Forceps	1

Patient Safety

ARM & LEG GUARD

LATEX FREE | REUSABLE

SunMed

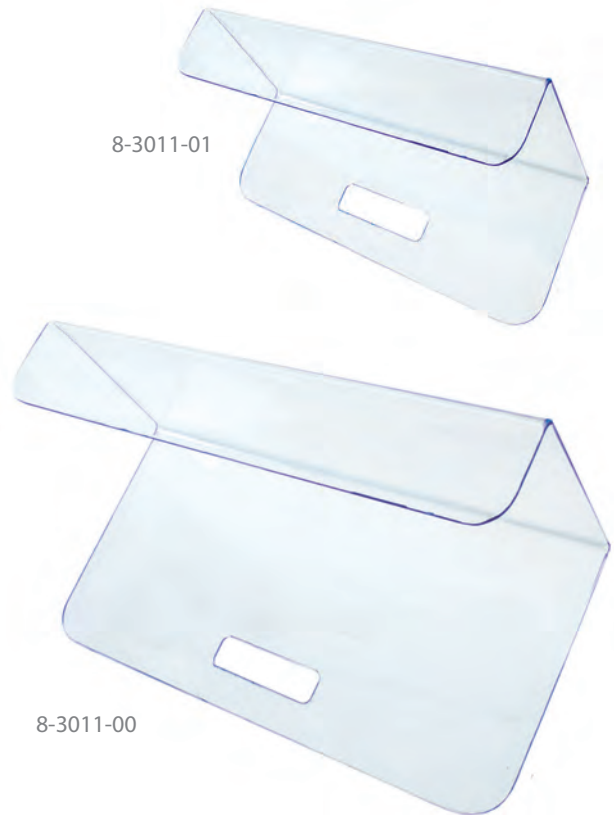

- Slides under mattress of bed or stretcher to safely secure arms and legs
- Protects IV, blood pressure cuff or CVP line from being compressed
- X-ray transparent and MRI compatible
- Durable crystal-clear acrylic can be easily cleaned
- Convenient hanger handle

CAT#	DESCRIPTION	PK
8-3011-01	7.5"W x 5.5"H x 10.5"L Small Guard	1
8-3011-00	15.5"W x 7.5"H x 9"L Large Guard	1



Urology

SILICONE FOLEY CATHETER

LATEX FREE | SINGLE USE | DISPOSABLE

SunMed



- Smooth tapered tip facilitates easy insertion into urethra
- Symmetrical balloon expands equally in all directions and efficiently retains bladder
- Plastic valve designed to permit simple inflation/deflation and more efficient than rubber valves
- Silicone material is preferred with less urethral irritation and stricture versus latex material
- Less encrustation compared to latex catheters
- Color-coded sleeves for easy and rapid size identification

CAT#	DESCRIPTION	VOLUME	SIZE	PK
7-6513-08	Pediatric Catheter	3cc	8Fr	10
7-6513-10	Pediatric Catheter	3cc	10Fr	10
7-6515-12	Adult Catheter	5cc	12Fr	10
7-6515-14	Adult Catheter	5cc	14Fr	10
7-6515-16	Adult Catheter	5cc	16Fr	10
7-6515-18	Adult Catheter	5cc	18Fr	10
7-6515-20	Adult Catheter	5cc	20Fr	10
7-6515-22	Adult Catheter	5cc	22Fr	10
7-6515-24	Adult Catheter	5cc	24Fr	10

Urology

LATEX FOLEY CATHETER

SINGLE USE | DISPOSABLE

SunMed

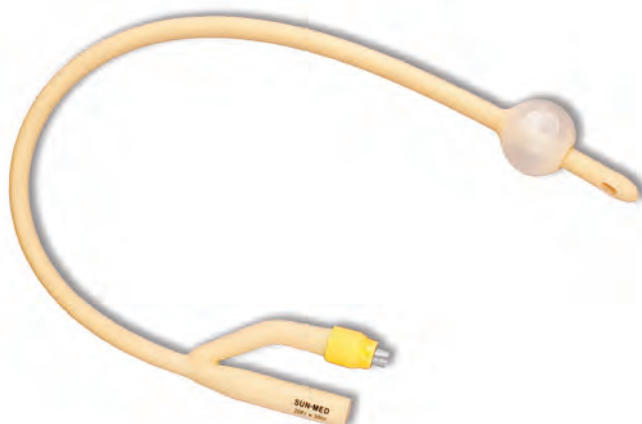

- Smooth tapered tip facilitates easy insertion into urethra
- Drainage eyes are accurately formed to permit effective drainage
- Symmetrical balloon expands equally in all directions and efficiently retains bladder
- Plastic valve designed to permit simple inflation/deflation and more efficient than rubber valves
- Color-coded sleeves for easy and rapid size identification
- Plastic valve permits simple inflation and deflation

CAT#	DESCRIPTION	VOLUME	SIZE	PK
7-6503-08	Pediatric Catheter	3cc	8Fr	10
7-6503-10	Pediatric Catheter	3cc	10Fr	10
7-6505-12	Adult Catheter	5cc	12Fr	10
7-6505-14	Adult Catheter	5cc	14Fr	10
7-6505-16	Adult Catheter	5cc	16Fr	10
7-6505-18	Adult Catheter	5cc	18Fr	10
7-6505-20	Adult Catheter	5cc	20Fr	10
7-6505-22	Adult Catheter	5cc	22Fr	10



Find What You Need

INDEX**A**

Acute 60 Connector..... 17
 Adapter, Metal 16
 Adhesive Disk.....98, 158
 Adjustable PEEP Valve 116
 Adjustable Robertazzi..... 112,125
 AGT/RAE Endotracheal Tube 18
 AirFlow Resuscitator.....26-27, 130-131
 Airways..... 8-19
 Aluminum Stylette..... 23
 Anesthesia Mask91-93
 Inflatable..... 91-92
 Non-Inflatable..... 93
 Arm Guard..... 168

B

Bacterial/Viral Filter..... 37,120
 Berman Airway 8, 124
 Bite Block..... 10, 135
 Bougie 20
 Bougie-to-Go 21, 127
 BreatheRite 121
 Breathing Bag 117
 Breathing Filter.....38-39, 118-120
 Bubble Humidifier 38, 105, 188, 145

C

Cannula 102-107
 Demand 104, 144
 End Tidal 106, 107
 ETCO2 146-147, 106-107, 160 -161
 ETCO2 with Scoop..... 147, 107,161
 Fits All Connector 102-107
 High Flow 144, 145, 104-105
 Scoop 147, 107, 161
 Standard 102,143
 Catheter 169
 Chemetron Stem 112
 Chest Piece.....98, 158
 Chrome Plated Handle 63, 88
 Circuit..... 41

Circuit Organizer.....40, 103
 Circuit, Breathing..... 41, 111, 151
 Circuit, MRI..... 41, 111, 151
 Circuit, Standard 41, 111, 151
 Clarity Pressure Infusion 95
 CO2 Indicator 156
 Coated Stylette..... 22
 Color Coded Guedel9
 Combiguard II..... 136
 Combiport..... 136
 ComfortFit Soft Ear Monoscope.....98, 158
 Christmas Tree Connector..... 142
 Connector, Endotracheal..... 16-17
 90 No Port 17
 Acute 60..... 17
 Corrugated..... 17
 Elbow 17
 Fletcher T-tube..... 17
 Rubber 16
 Stainless Steel 17
 Straight..... 17
 Summers T-Tube 17
 T-Adapter..... 17
 Universal 16
 Washington T-Tube 17
 Copper Stylette 23
 Corrugated Connector 17
 Corrugated Tubing.....26-33
 Coude Tip Introducer20-21
 CPR Mask..... 115, 138
 Cuff Inflation Bulb 14
 Cushion Mask.....91-93

D

Demand Cannula..... 104, 144
 Diagnostic Kit..... 155
 Disposable Stylette.....22-23
 Double Foam Eye Protector.....97, 167
 Dual Head Stethoscope 99, 139, 159
 Dual Lumen Endobronchial Tube..... 19

E

Elbow Connector 17
 End Tidal Cannula..... 106-107

Endobronchial Tube 19
 Endotracheal Tube14-15, 18, 126
 Cuffed 15, 126
 Cuffed with Stylette..... 15, 126
 Preformed..... 18
 Reinforced 15
 Uncuffed 15, 126
 ERGO Mask..... 114
 ET Tube Connector..... 16-17
 ETCO2 Cannula..... 160-161, 106-107, 146-147
 ETCO2 Cannula with Scoop..... 107, 147, 161
 Eye Protector.....97, 167

F

Face Mask.....93, 114-115
 Fiber Optic Replacement Lamps..... 62
 Fiber Optic Stylette 22
 Filter
 B/V..... 37, 120
 Breathing38-39, 118-120
 HEPA 38
 Fingertip Pulse Oximeter..... 155
 Flat Breathing Bag..... 117
 Fletcher T-Tube 17
 Flex Neck26-33
 Flex Tubing..... 37
 Flexible Anesthesia Mask..... 93
 Flexible Metal Adapter 16
 Foley Catheter 169
 Forceps..... 138, 168
 Closed Magill..... 138, 168
 Open Magill 138, 168

G

Gastric Lavage 134
 GreenLine.....48-65
 GreenLine/D.....44-47
 Guedel Airway 8-9
 Color Coded.....9
 PVC.....9
 Traditional 8, 124

H

Hand Strap 26



Handles

- Chrome Plated..... 63, 88
- Conventional..... 88
- Disposable..... 47
- Fiber Optic..... 63-65
- Premium 63, 64
- Replacement Lamp..... 62
- Stainless Steel 64
- Sunbrite..... 65
- Waterproof..... 88

Harness, Mask 93, 115

HCH (Hydroscopic Condenser Humidifier).... 38

HCHF 39

HEPA Filter..... 38, 118

High Concentration Oxygen Mask..... 108, 148

High Flow Cannula..... 144-145, 104-105

High Flow Cannula with Humidifier 105

HME (Heated Moisture Exchanger)..... 38, 118

HMEF..... 39, 119

Howland Lock..... 65, 89

Hyperinflation System 34-35

I

IGuard 97, 167

Inflatable Anesthesia Mask..... 91-92

Infu-Surg Clarity Pressure Infusion..... 95

Infu-Surg Pressure Infusion..... 94, 137

Instrument Holder..... 164-165

Instrument Pocket..... 164-165

Integrity Pressure Infusion Bag 96

Introducer 20-21

- Bougie..... 20
- Bougie-to-Go 21, 127
- Malleable 20
- Ported 21

Intubation Kit..... 11, 66, 90, 128

J

Jaw Spreader..... 10, 135

K

Kits, Laryngoscope..... 66-69, 86-87, 89, 129

L

Lap-Kit 168

Laryngoscope, Fiber Optic, Disposable..... 44-47, 66-67

- Macintosh..... 44, 46
- Miller 44, 46
- Robertshaw 45
- Flex-Tip 45
- Handles 47
- Kits 66-67, 89, 129
- All Metal 46
- SunOne System 44-47

/Laryngoscope, Fiber Optic, Reusable 48-65

- American Profile..... 49, 50-51, 56-59
- Blechman..... 51
- Cranwall 57
- English Profile 52-54, 60-61
- Flange-less 50
- German Profile..... 48, 55
- Handle 63-65
- Improved Vision 50, 53
- Macintosh..... 48-55
- Miller 56-61
- Miller-Port..... 57
- Oxford..... 61
- Phillips 59
- Polio..... 52
- Prismview 51, 53
- Reduced Flange 54
- Robertshaw..... 61
- Seward..... 60
- Siker Mirror 55
- Snow 56
- Soper..... 61
- Sunflex..... 54
- Whitehead..... 59
- Wisconsin 58
- Wis-Hipple..... 58

Laryngoscope, Conventional, Disposable 70

- Macintosh..... 70
- Miller 70

Laryngoscope, Conventional, Reusable

- American Profile..... 71-73, 78-82
- Blechman..... 73

Cranwall 79

English Profile 74-77, 83-85

Flange-less 73

Handle 88

Improved View..... 72

Macintosh..... 71-77

Miller 78-85

Miller-Port..... 81

Quedal 84

Replacement Lamps 89

Schapira 82

Oxford 83

Phillips 80

Polio..... 77

Prismview 73, 75

Reduced Flange 76

Robertshaw..... 84

Seward..... 85

Siker Mirror 72

Snow 79

Soper..... 85

Sunflex..... 75

Whitehead..... 82

Wisconsin 80

Wis-Hipple..... 81

Laryngoscope Kits..... 66-69, 86-87

Latex Robertazzi 13

Lavage Tubing 135

Leg Guard..... 168

Lighted Stylette..... 22

M

Magill Forceps..... 138, 168

Manometer 26, 35

Manual Resuscitation Training Kit..... 36

Manual Resuscitator 26-33

Manual Ventilator 26-35

Mask..... 91-93, 108-109, 114-115

- Anesthesia..... 91-93
- Inflatable..... 91
- Non-Inflatable..... 92-93

Oxygen 108-109

Mask Harness 93, 115

MDI Spacer.....	121	Pressure Infusion Bag.....	94-96	Copper.....	23
Medical Gas Fitting.....	112	Clarity.....	95	Disposable.....	22-23
Medication Delivery.....	94-96	Infu-Surg.....	94,137	Fiber Optic.....	22
Medium Concentration Oxygen Mask	109,149	Integrity.....	96	Lighted.....	22
Mini-Write Peak Flow Meter.....	116, 157	Pressure Manometer.....	26-35	PVC.....	22
Monoscope.....	98, 158	PVC Guedel.....	9	Reusable.....	22-23
Mouthpiece, Flow Meter.....	117, 157	PVC Nasopharyngeal.....	13	Stainless Steel.....	23
MRI Transport Circuit.....	41, 111, 151	PVC Stylette.....	22	Summers T-Tube.....	17
N		R		Sunbrite Handle.....	65
Nasal Cannula.....	102, 143	Replacement Lamps.....	62, 89	SunStim Peripheral Nerve Stimulator.....	154
Nasal Preformed.....	18	Resuscitator, Manual.....	26-33	SunStim Plus Peripheral Nerve Stimulator..	154
Nasopharyngeal Airway.....	12-13	Airflow.....	26-27	Surgi-Kit.....	164
Nerve Stimulator.....	154	Safe Spot.....	30-31	SunOne System.....	44
Non-Inflatable Mask.....	93	STAT Check II.....	32-33	T	
Non-Rebreather Mask.....	108, 148	V-Care.....	28-29	T-Adapter Connector.....	17
Nose Clip.....	103	Reusable Stylette		Test Lung.....	117
O		Robertazzi.....	12-13, 125	TIB Connector.....	17
Ohmeda Stem.....	113	Adjustable.....	12, 128	Tongue Seizing Forceps.....	138
Oral Preformed Airway.....	18	Latex.....	13	Tooth Protector.....	10, 167
Oropharyngeal Airway.....	8-10	Latex Free.....	12, 125	Tracheostomy Tube.....	19, 127
Otoscope.....	156	Robertshaw Endobronchial Tube.....	19	Cuffed.....	19, 127
Oximeter.....	155	Robertshaw Endobronchial Tube, Left.....	19	Uncuffed.....	19, 127
Oxygen Cannula.....	102, 143	Robertshaw Endobronchial Tube, Right.....	19	Traditional.....	
Oxygen Delivery.....	142, 151	Rubber Connector.....	16	Training Kit.....	36
Oxygen Flow Meter.....	110, 142	Racine Connector.....	16	Training Kit, Manual Resuscitation.....	36
Adapter.....	16	S		Tru-Flow Oxygen Flow Meter.....	110, 142
Chemetron Inlet.....	112	Safe Spot.....	30-31	T-Tube Connector.....	17
Hand Nut Inlet.....	112-113	Sampling Cannula. 146-147, 106-107, 160-161		Tube Tree.....	40, 103, 150, 166
Ohmeda Inlet.....	113	Scoop Cannula.....	107	Tubing	
Oxygen Mask.....	108-109	Soft Seal Mask.....	92	3 Channel.....	149
Oxygen Reservoir.....	26-33	Softaire Mask.....	91	Lavage.....	135
Oxygen Tubing.....	109	Spacer		Oxygen.....	109, 149
P		Collapsible.....	121	Tum-E-Vac Gastric Lavage.....	134
Partial Non-Rebreather Mask.....	108,148	Rigid.....	121	V	
Peak Flow Meter.....	116, 157	Sprague Rappaport Stethoscope.....	159	Valved Holding Chamber.....	121
PEEP Valve.....	116	Staight Tip Introducer.....	20-21	V-Care.....	28-29
Pocket Mask.....	115, 138	STAT Check CO2 Indicator.....	156	Vent Mask.....	91
Pop-Off Valve.....	26-35	STAT Check II.....	32-33	Vent Mask II.....	92
Ported Introducer.....	21	Stethoscope.....	99, 139, 159	Ventilator, Manual.....	34-35
Precordial Set.....	98	Straight Connector.....	17	W	
Preformed Airway.....	18	Stylette.....	22-23	Washington Connector.....	17
Preformed Endotracheal, Cuffed.....	18	Aluminum.....	23	Wenger Chest Piece.....	98, 158
Preformed Endotracheal, Uncuffed.....	18	Coated.....	22	Williams.....	10
				Wound Irrigation.....	136



FOR COMPLETE
Customer Service
Technical Information
Care/Cleaning Instructions
Product Literature

CALL
800-433-2797

VISIT
www.Sun-Med.com

EMAIL
info@Sun-Med.com

SunMed

Ventlab

Ethox

[Airway Management](#) | [Resuscitation/Ventilation](#) | [Anesthesia](#) | [Respiratory](#) | [Emergency](#) | [Oxygen Delivery](#) | [Diagnostics](#) | [Surgical](#)



2710 Northridge Dr. NW, Suite A
Grand Rapids, MI 49544 USA
www.Sun-Med.com
800-433-2797 | 616-259-8400
616-647-3430 fax
info@Sun-Med.com

